

SHARP[®]

香港電器安全規格
(國際電工委員會規格適合)

LC-60UA50H
LC-70UA50H

液晶彩色電視機
LCD COLOUR TELEVISION
使用說明書
OPERATION MANUAL

SHARP[®]
SHARP CORPORATION

AQUOS

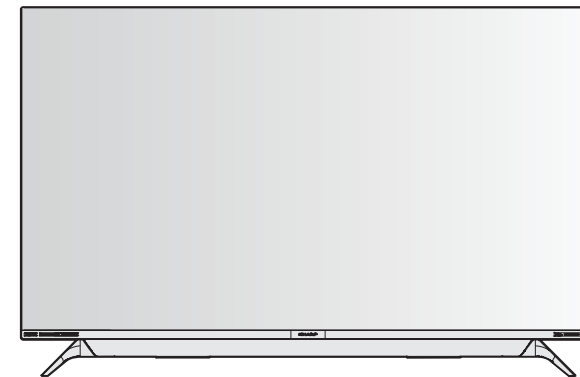

HDMI[®]
HIGH-DEFINITION MULTIMEDIA INTERFACE

micro
SD

DOLBY AUDIO[™]

dts[®]
2.0+ Digital Out

Bluetooth[®]

TINS-G952WJZZ

中文

ENGLISH



使用說明書

親愛的SHARP顧客

衷心感謝惠購SHARP液晶彩色電視機。為確保安全使用本機及令本機更加耐用，在使用本產品之前請務必仔細閱讀關於安全的重要注意事項。

目錄

引言

親愛的 SHARP 顧客	1
目錄	1
日常使用的注意事項	3
關於安全的重要注意事項	4
商標	5
附件	6

準備

安裝底座組件	7
簡易平台的製作方法 (只適用於 LC-70UA50H)	8
壁掛電視機的處置和注意事項	9
部件名稱	9
電視機 (前視圖)	9
電視機 (後視圖)	10
遙控器	11
電視機操作按鍵	12
配對遙控器	12
在開啟電源之前	13
連接外部設備	14
使用數碼音頻輸出	15
插入 Micro SD記憶卡 (市面有售)	15
連接 USB 存儲設備	15
連接到網絡	15
裝入電池	16
關於遙控器的注意事項	16
開啟或關閉電視機	17
首次開啟電視機	17
關閉電視機	17
用戶指南	17

觀看電視

選項表	18
聲音切換	18
音頻語言	18
字幕語言	18
回看	18
信息	18
EPG	18
頻道列表	18
頻道編輯	19
數字鍵盤	19
HDMI 選擇	19
電腦顯示模式	19
設置	19
一般設置	19
主題	19
開機狀態	19
語言設置	19
預設輸入法	19
滑鼠速度	19
無訊號自動關機	19
定時關機	20
待機指示燈	20
開機音效	20

觀看電視 (續)

影像	20
影音模式	20
對比度 / 亮度 / 色調 / 銳度 / 色彩 / 背光 / 伽瑪校正	20
色溫	20
寬屏模式	20
圖像抑噪	21
動態對比度	21
Fine Motion	21
智能對比度	21
HDR 伽瑪校正	21
還原	21
音頻	21
影音模式	21
自動音量	21
低音 / 高音 / 平衡	21
環繞聲	21
音頻輸出	21
還原	21
頻道設置	22
執行自動頻道搜尋	22
數碼頻道設置	22
模擬頻道設置	22
頻道編輯	22
網絡	22
應用程式	22
選項	23
數碼音頻語言	23
字幕	23
適用於聽力障礙者	23
系統	23
系統訊息	23
法律訊息	23
本地更新	23
系統還原	23

網絡功能

連接到網絡	24
有線安裝準備	24
無線安裝準備	24
網絡設置	25
有線網絡連接	25
無線網絡連接	25
藍牙設置	25

智能功能

智能界面	26
電視界面	26
應用界面	26
安裝應用	26
應用程式	26
輸入文字	26
瀏覽器	26

其他有用功能

連接 USB 存儲設備	27
播放 USB 存儲設備中的檔案	27
用於 USB 多媒體選項表操作的按鈕	28
與 USB 模式相容的檔案列表	29

附錄

故障分析	31
規格	32
輪廓圖	33

日常使用的注意事項

請遵守以下事項

外殼的保養方法

- 清潔外殼的時候，請用柔軟的布（棉、絨等質料）輕輕地擦拭。請不要使用附有化學成分的乾、濕抹布，因為這樣會導致外殼本體成分的變質或裂開。
- 請注意不要使用質地堅硬的布來擦拭，或擦拭時過於用力，這樣會導致外殼表面劃傷。
- 外殼不潔的時候，可使用柔軟的布（棉、絨等質料）浸取少量稀釋過的中性洗劑，擰乾後擦拭，然後再用柔軟的乾布擦乾。
- 由於外殼為塑膠製品，汽油、稀釋劑類的溶劑會導致其變質，或塗料脫落，所以請不要使用此類溶劑來清潔外殼。
- 由於塑膠中含有塑化劑，與某些物質接觸會出現變質、塗料脫落等狀況，所以請遠離殺蟲劑等揮發性物質。另外，請不要與橡膠和樹脂類製品長期接觸。

屏幕的保養方法

- 在開始清潔屏幕之前，請務必關閉電視機電源，並將電源插頭從插座中拔出。
- 清潔屏幕時，請使用柔軟的乾布（棉、絨等質料）來輕輕擦拭屏幕表面。為了保護屏幕，請不要使用不乾淨的布、清洗劑、或附有化學成分的乾、濕抹布等物品來擦拭，因為這樣會造成顯示屏表面的剝落。
- 請注意不要使用質地堅硬的布來擦拭，或擦拭時過於用力，這樣會導致顯示屏表面劃花。
- 屏幕不潔的時候，可以用柔軟的布（棉、絨等質料）稍微用水打濕後，輕輕地擦拭（擦拭時不可過於用力，以免造成顯示屏表面劃花）。
- 如果液晶顯示屏表面黏上了灰塵，請使用市面有售的除塵刷（除靜電刷）來清潔。

關於安全的重要注意事項

- 清掃 — 在清掃本機之前，務必先將交流電源線插頭從交流電源插座中拔出。用擰乾的濕布將本機擦拭乾淨。請勿使用液態清潔劑、噴霧清潔劑或化學布料清潔，因為這類材質可能會對產品造成損害。



- 水和潮濕 — 不要在近水之處使用本機，例如在靠近洗澡盆、洗臉盆、廚房洗滌槽、洗衣盆、游泳池等，也不要潮濕的地下室中使用。



- 請勿在本機之上放置花瓶或任何其他盛水的容器，或將本機放置在冷氣機、加濕器等電器下面。若有水滴濺到本機之上，就可能引起火災或觸電。



- 台座 — 不要將本機放置於不穩定的推車、台座、三腳架或桌面上。不穩固的基座可能會使本機掉落，導致嚴重的人身傷害、以及產品損壞。請僅使用本製造商所推薦或與本產品配套出售的推車、台座、三腳架、托架或桌子。將本機安裝於牆上時，請務必遵照本製造商的指示，而且只可以使用本製造商所推薦的安裝器材。



- 將本機放置於推車上搬運時，必須小心注意安全。急停、用力過度、地面不平等等，都會導致本機從推車上掉落。



- 通風 — 本機外殼上的散熱孔與其他開口之處，用於散熱通風。請勿堵塞這些散熱孔或開口之處，通風散熱不良會使本機過熱、縮短本機的使用壽命。請勿將本機置於臥床、沙發、地毯或其他類似物品之上，因為這些物品會堵塞散熱通風孔。本產品之設計不適用於嵌入式安裝，所以不要將本機置於像書櫃、機架等封閉之處，除非提供合適的通風或遵照本製造商的專門指示說明。

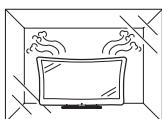

- 本機如果不慎掉落，外殼破損，請務必關閉本機電源，並拔出插頭。如果繼續使用，會有火災和觸電的危險。



- 請不要打開後殼改造電路。內部存在高電壓，會引起觸電傷害。如果需要檢修，請聯絡經銷商。



- 本機所用之液晶顯示屏是用玻璃製造的。因此，在受到強力撞擊或被尖銳物刻劃時會損壞。萬一液晶顯示屏破碎，請小心不要受到碎玻璃的割傷。



- 熱源 — 請勿讓本機接近熱源，如取暖器、加熱器、火爐或其他任何會產生熱力的東西（包括擴音機在內）。



- 為防止發生火災，請勿將任何種類的蠟燭或火焰置於本機的頂部或其附近。

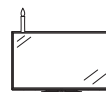

- 為了防止遭受起火或觸電的危險，請勿將交流電源線置於本機或其他重物之下。

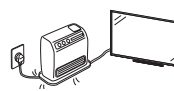

- 請勿在本機之上放置重物或攀爬於本機之上。這樣做可能導致本機傾倒而造成傷害。特別要注意近旁的兒童和寵物。



- 搬運電視機之前，請先把插頭拔出。如果不預先拔出，很容易拉損電源線，產生觸電危險。

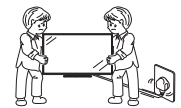

液晶顯示屏是用非常高超的技術製造的，具有 8,294,400 個像素，能顯示出精細的畫面。由於像素數目極多，偶然也可能會有一些無效的像素出現在屏幕上，看上去是固定不變的藍色、綠色或紅色的亮點。請注意，這是屬於產品規格範圍之內，並不是故障。

在搬運電視機時的注意事項

- 在搬運電視機時，切勿握住顯示屏搬運或使顯示屏受到壓力。在搬運本電視機時，無論何時都必須由兩個人以上用雙手搬運 — 電視機的每一側用一隻手握住。



- 請勿長時間顯示靜止影像，這可能會導致殘留影像。

- 請將本機安裝於能將交流電源線容易從交流電源插座拔出的地方。

註

- 以上均為示意圖，以實物為準。

商標

- Dolby, Dolby Audio, 和雙D記號是杜比實驗室的商標。本產品經過杜比實驗室的授權而製造。未公佈的機密作品。版權所有1992–2015杜比實驗室。保留所有權利。
- HDMI、HDMI高清晰度多媒体接口及HDMI 商標為HDMI Licensing Administrator, Inc. 於美國及其他國家的商標或註冊商標。
- **For DTS patents, see <http://patents.dts.com>. Manufactured under license from DTS, Inc. DTS, the Symbol, DTS and the Symbol together are registered trademarks or trademarks of DTS, Inc. in the United States and/or other countries © DTS, Inc. All Rights Reserved.
- Wi-Fi CERTIFIED 標誌是 Wi-Fi 聯盟的認證標誌。
- SDHC logo is a trademark of SD-3C, LLC
- MPEG Layer-3 audio coding technology licensed from Fraunhofer IIS and Thomson.
- THIS PRODUCT IS LICENSED UNDER THE AVC PATENT PORTFOLIO LICENSE FOR THE PERSONAL USE OF A CONSUMER OR OTHER USES IN WHICH IT DOES NOT RECEIVE REMUNERATION TO (i) ENCODE VIDEO IN COMPLIANCE WITH THE AVC STANDARD ("AVC VIDEO") AND/OR (ii) DECODE AVC VIDEO THAT WAS ENCODED BY A CONSUMER ENGAGED IN A PERSONAL ACTIVITY AND/OR WAS OBTAINED FROM A VIDEO PROVIDER LICENSED TO PROVIDE AVC VIDEO. NO LICENSE IS GRANTED OR SHALL BE IMPLIED FOR ANY OTHER USE. ADDITIONAL INFORMATION MAY BE OBTAINED FROM MPEG LA, L.L.C. SEE [HTTP://WWW.MPEGLA.COM](http://www.mpegla.com)
- THIS PRODUCT IS LICENSED UNDER THE MPEG-4 VISUAL PATENT PORTFOLIO LICENSE FOR THE PERSONAL AND NON-COMMERCIAL USE OF A CONSUMER FOR (i) ENCODING VIDEO IN COMPLIANCE WITH THE MPEG-4 VISUAL STANDARD ("MPEG-4 VIDEO") AND/OR (ii) DECODING MPEG-4 VIDEO THAT WAS ENCODED BY A CONSUMER ENGAGED IN A PERSONAL AND NON-COMMERCIAL ACTIVITY AND/OR WAS OBTAINED FROM A VIDEO PROVIDER LICENSED BY MPEG LA TO PROVIDE MPEG-4 VIDEO. NO LICENSE IS GRANTED OR SHALL BE IMPLIED FOR ANY OTHER USE. ADDITIONAL INFORMATION INCLUDING THAT RELATING TO PROMOTIONAL, INTERNAL AND COMMERCIAL USES AND LICENSING MAY BE OBTAINED FROM MPEG LA, L.L.C. SEE [HTTP://WWW.MPEGLA.COM](http://www.mpegla.com)
- Bluetooth®文字標誌和圖形標誌為 Bluetooth SIG, Inc. 所有的註冊商標，且SHARP 在授權下使用任何該等標記。其他商標和商名為各自所有者的商標和商名。

DISCLAIMERS









- This SHARP device facilitates the access to content and services provided by third parties. The content and services accessible via this device belong to and may be proprietary to third parties. Therefore, any use of such third party content and services must be in accordance with any authorization or terms of use provided by such content or service provider. SHARP shall not be liable to you or any third party for your failure to abide by such authorization or terms of use. Unless otherwise specifically authorized by the applicable content or service provider, all third party content and services provided are for personal and non-commercial use; you may not modify, copy, distribute, transmit, display, perform, reproduce, upload, publish, license, create derivative works from, transfer or sell in any manner or medium any content or services available via this device.
- SHARP is not responsible, nor liable, for customer service-related issues related to the third party content or services. Any questions, comments or service-related inquiries relating to the third party content or service should be made directly to the applicable content or service provider.
- You may not be able to access content or services from the device for a variety of reasons which may be unrelated to the device itself, including, but not limited to, power failure, other Internet connection, or failure to configure your device properly. SHARP, its directors, officers, employees, agents, contractors and affiliates shall not be liable to you or any third party with respect to such failures or maintenance outages, regardless of cause or whether or not it could have been avoided.
- All third party content or services accessible via this device is provided to you on an "as-is" and "as available" basis and SHARP and its affiliates make no warranty or representation of any kind to you, either express or implied, including, without limitation, any warranties of merchantability, non-infringement, fitness for a particular purpose or any warranties of suitability, availability, accuracy, completeness, security, title, usefulness, lack of negligence or error-free or uninterrupted operation or use of the content or services provided to you or that the content or services will meet your requirements or expectations.
- SHARP is not an agent of and assumes no responsibility for the acts or omissions of third party content or service providers, nor any aspect of the content or service related to such third party providers.
- In no event will SHARP and/or its affiliates be liable to you or any third party for any direct, indirect, special, incidental, punitive, consequential or other damages, whether the theory of liability is based on contract, tort, negligence, breach of warranty, strict liability or otherwise and whether or not SHARP and/or its affiliates have been advised of the possibility of such damages.

- 本使用說明書已進行過嚴格的校勘和核對，但因軟體升級等因素，SHARP 不能保證用戶實際操作與說明書描述完全一致。

附件

隨機附件

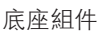
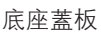
請確認如下附件隨同本機附送。

遙控器	
 <p>插入電池使用。 第 11 頁</p>	
“AA” 型電池 (× 2)	使用說明書
 <p>第 16 頁</p>	
底座組件	
 <p>“L” 底座組件</p>	 <p>“R” 底座組件</p>
 <p>“L” 底座蓋板</p>	 <p>“R” 底座蓋板</p>
 <p>底座組件</p>	 <p>底座蓋板</p>
	 <p>長螺絲釘 (× 4) 短螺絲釘 (× 2)</p>
第 7 頁	

準備

安裝底座組件

- 安裝底座組件時，需將電視機正面朝下平放在平台上。
- 在安裝（或拆卸）底座組件之前，請將交流電源線從交流電源插座中拔出。
- 在執行操作之前，請在將放置電視機的地方鋪設減震墊，以防電視機損壞。

注意

- **正確安裝底座組件。**
- **請務必遵照說明進行安裝。若底座組件安裝不正確，則可能導致電視機傾倒。**

- 1** 將電視機如圖平放於軟墊上，撕下兩側膠紙，將音箱兩側的底座蓋板取下。

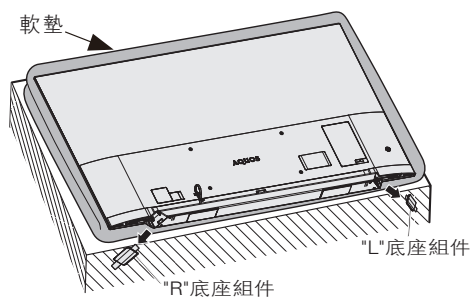

- 4** 將音箱兩側的底座蓋板（小）分別壓進音箱的左右空槽內，確保蓋板壓緊。

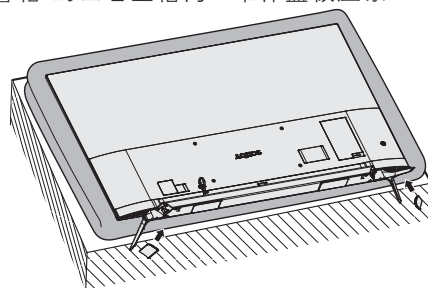

- 2** 將左右底座組件分別插入電視機底部的凹槽內，再向電視機中間位置橫向移動，請確保底座卡住音箱。

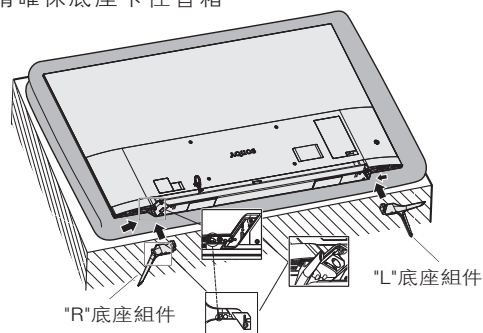

特別說明：如果使用壁掛安裝，請先按照步驟1進行，取下蓋板之後，將蓋板上的雙面膠隔離紙撕下，再將蓋板壓進音箱兩側，然後進行壁掛安裝。

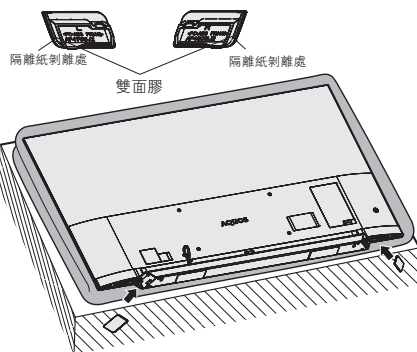

- 3** 將6枚螺絲釘分別插入到左右底座的6個螺絲孔中並擰緊。

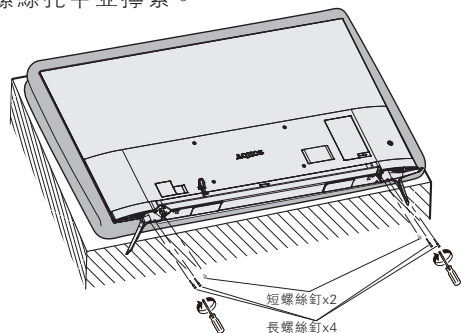

註

- 安裝底座時，需將電視機正面向下平放在平台上，平放前先在平台上鋪一層軟墊。
- 若要拆下底座組件，請按相反的順序執行以上步驟。
- 底座組件不允許調節角度。
- 本產品未有附帶螺絲批。
- 在安裝過程中，請小心操作，以免您的手被電視機底部和地面夾到。

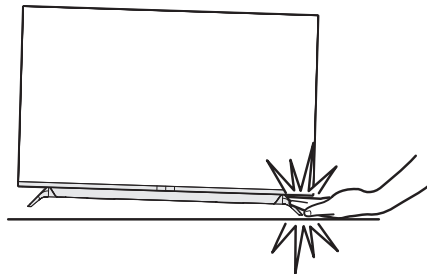

準備

簡易平台的製作方法 (只適用於 LC-70UA50H)

要製作簡易平台，需使用包裝箱及其內部的 3 個發泡膠，TOP-L、TOP-C、TOP-R。

1 如下圖所示，請取下紙箱底部的卡扣。

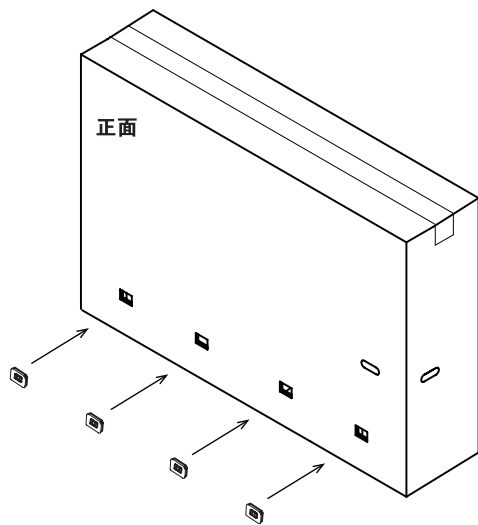

2 按下圖所示方法，請從頂部拆開包裝箱，並取出頂面的 3 個發泡膠 (TOP-L、TOP-C、TOP-R)。

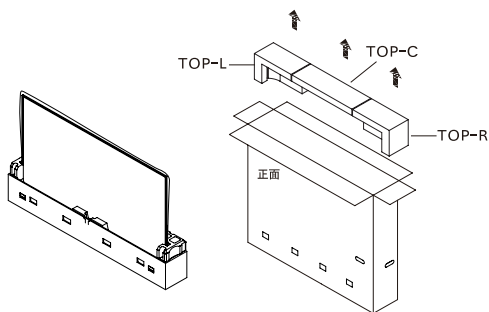

3

- 1 如圖 A 所示，請將包裝箱正面向下放置。
- 2 將 TOP-L 和 TOP-R 分別裝入包裝箱內的右側和左側。(裝入位置如圖 B 所示)
- 3 將 TOP-C 裝入包裝箱內的中間部位 (裝入位置如圖 B 所示)，即完成簡易平台的製作。

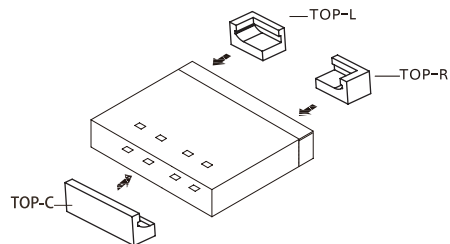

(圖 A)

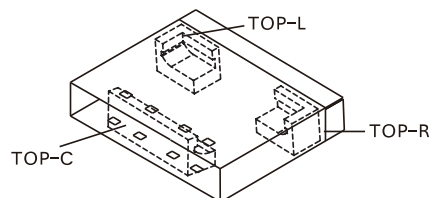

(圖 B)

註

- 簡易平台製作完成後，請放置在平坦的地面上。
- 安裝底座時，需要將電視機正面向下平放，平放前請先在平台上鋪設一層軟墊以保護屏幕。
- 簡易平台只是臨時平台，請不要施加超過液晶電視機重量的負荷。

準備

壁掛電視機的處置和注意事項

- 可用另外購買的托架，將電視機安裝在牆上。
- 詳情請參閱另外購買的托架所附之說明書。

注意

- 本電視機只能使用 SHARP 公司推薦的掛牆架來將電視機安裝到牆上。使用其他掛牆架可能導致安裝不穩而引致嚴重人身傷害。
- 安裝液晶彩色電視機需要特別的技能，只有具有專業資格的服務人員才能夠安裝。用戶不可自己進行這項工作。對於不正確的安裝，或是由於安裝引起的事故或傷害，SHARP 不承擔任何責任。

使用另外購買的托架來安裝電視機

- 可請經資質認證的服務人員用另外購買的托架將電視機安裝到牆上。
- 在開始操作之前，請先仔細閱讀隨同托架提供的使用說明書。

部件名稱

電視機（前視圖）

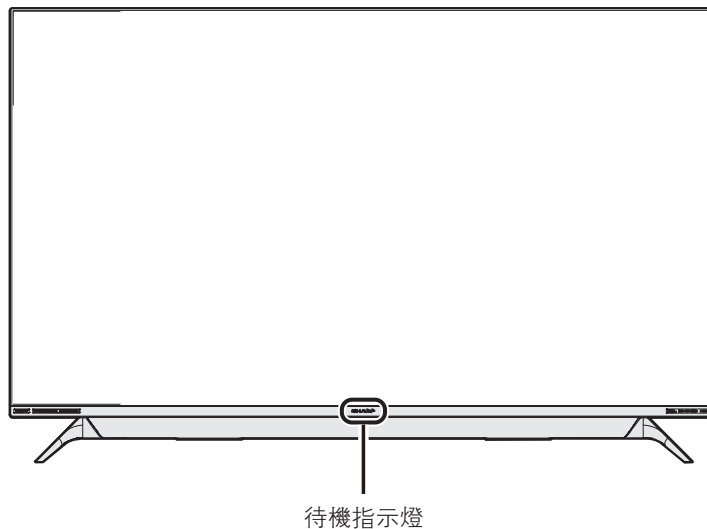

- 本說明書中的插圖和螢幕顯示是以解釋為目的，可能與實際操作略有差別。
- 本說明書中所有插圖全部是根據 LC-60UA50H 進行說明。

準備

電視機 (後視圖)

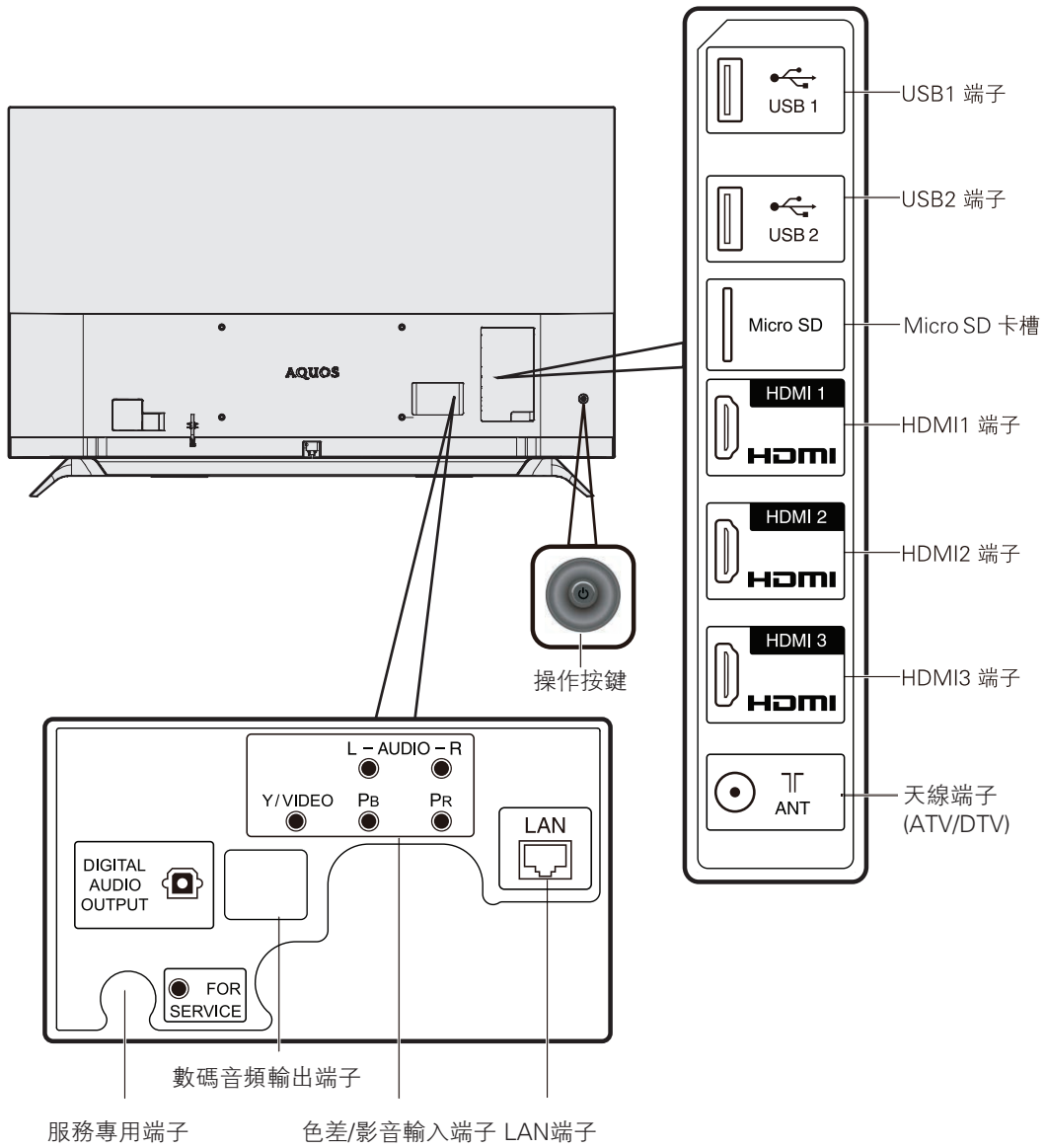

準備

遙控器

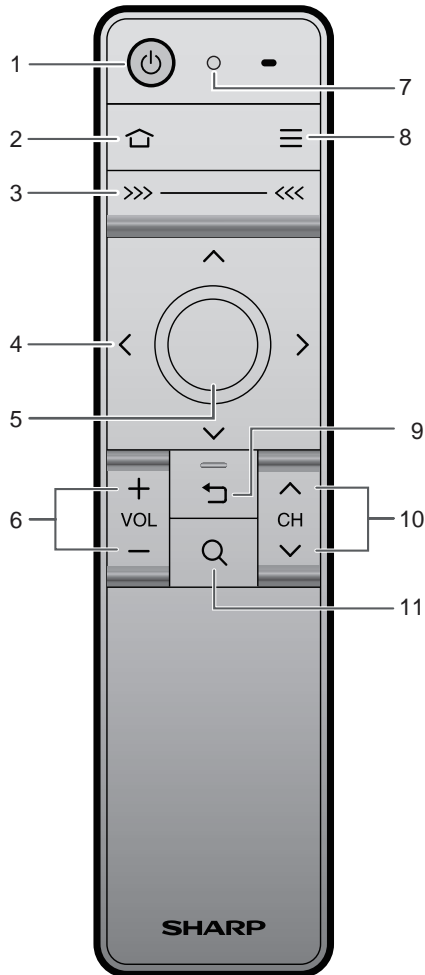

- 1 电源 (電源備用 / 開啟)**
開啟和關掉電源。(請參閱第 17 頁。)
- 2 主页**
按該鈕進入智能界面。
- 3 SLIDE BAR**
左、右滑動滑動桿，可在智能界面中切換電視或應用界面。
- 4 ▲/▼/◀/▶ (游標)**
在設置畫面上選擇一個所需的項目。
- 5 OK (輸入)**
執行一個命令。
- 6 VOL +/- (音量 +/-)**
設置音量。
- 7 INDICATOR**
遙控器指示燈。
- 8 三 (選項表)**
顯示電視機的選項表。
- 9 返回**
返回到前一個選項表畫面。
- 10 CH ▲/▼ (頻道 ▲/▼)**
電視輸入模式：選擇上一個 / 下一個頻道。
- 11 Q (瀏覽器)**
按該鈕進入瀏覽器界面。

註

- 當遙控器處於休眠時，只需按下遙控器上的任何按鍵（除電源鍵外）去喚醒遙控器便可使用。

遙控器指示燈

指示燈	閃燈效果	指示狀態	功能說明
藍燈	快速閃爍	提醒	遙控器配對開始。
	持續亮3秒	提醒	遙控器配對成功。
紅燈	持續3秒慢閃	警告	遙控器電量不足，此時遙控器仍可使用。
	持續3秒快閃	警告	遙控器電量嚴重不足。此時遙控器不可使用。
	持續亮3秒	警告	遙控器配對超時，遙控器配對不成功。
藍燈、紅燈	交替閃爍	提醒	解除現在的遙控器與電視機之間的配對，此時新遙控器可與電視進行配對。

準備

遙控器滑鼠功能

智能遙控器內置陀螺儀感測器，可用遙控器的動作感應去控制電視機。

遙控器帶有滑鼠功能，適用於在智能界面，通過操作遙控器來移動螢幕上的游標選擇所需的項目，按下 **OK** 後進入。

- 當滑鼠功能休眠時，輕晃遙控器可以重新啟動滑鼠功能。

電視機操作按鈕

您也可以使用電視機上的操作按鈕來進行電視設置。
(電視機的操作按鈕位置請參閱第 10 頁的電視機後視圖。)



按鈕動作	功能
短按	電視關機狀態下：開機
左 / 右	音量 減 / 加
上 / 下	頻道 上 / 下
長按	電視機開機狀態下：顯示選項 (配對 / 關機) (遙控器配對請參閱本頁。)

配對遙控器

隨本機附送的遙控器在出廠前已經與電視配對，可以直接使用。如果您發現遙控器無法正常操控電視或更換了新的遙控器時，請按照下面方法將遙控器與電視進行配對。

- 1 長按電視機上的電源按鈕，畫面會顯示“配對”、“關機”的選項。
- 2 使用電視機背部的按鈕，選擇“配對”，然後按下電視機操作按鈕。
- 3 將遙控器靠近電視機左下角 (20 厘米以內)。同時按下遙控器上的 **OK** 和 **⏻**，直到遙控器紅藍燈交替閃爍完畢。
- 4 再次按下 **OK**，直到畫面提示配對成功。

註

- 如果電視機沒有顯示遙控器配對資訊時，電視機會自動顯示“配對”界面。按下遙控器上的 **OK** 和 **⏻**，遙控器會紅藍燈交替閃爍，待閃爍停止後，再次按下 **OK**，直到畫面提示配對成功。
- 若遙控器配對不成功，請再嘗試一次或與客戶服務中心聯繫。

準備

在開啟電源之前

設置電視機位置之說明

- 勿使電視機受到陽光直射，並將其置於通風良好之處。
- 請將電視機置於水平的地方。
- 在連接交流電源線之前，請勿開啟電視機的電源。
- 若本機外殼上貼有保護膜，為了確保正常使用本機，請在使用前將其去除。

1 連接天線

為了能盡情享受清晰的電視影像，請使用室外電視天線。以下是關於同軸連接線的連接方法之簡要說明。

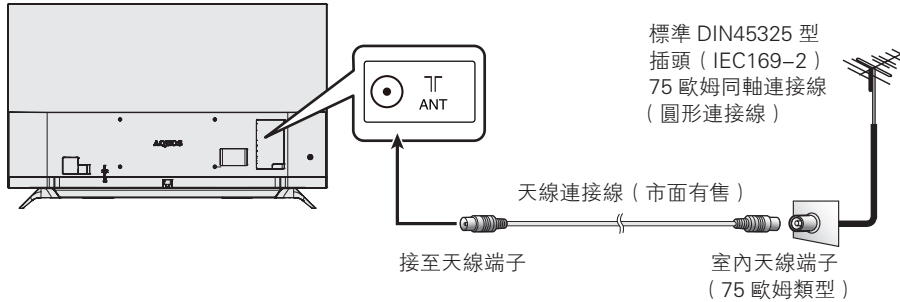

2 連接外部設備

關於連接錄影機和 DVD 影碟機等的外部設備，請參閱第 14 頁和第 15 頁。

3 將交流電源線插入交流電源插座。

- 1 將天線連接到電視機的背面。
- 2 將電視機的交流電源插頭插入交流電源插座。

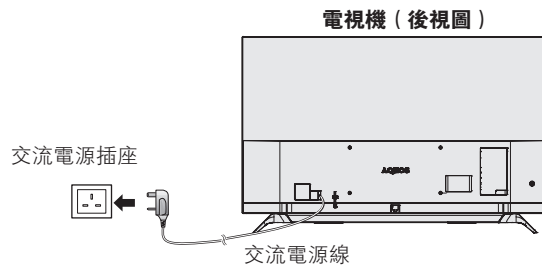

- 請將電視機置於靠近交流電源插座之處，並使電源插頭便於插拔。
- 如長期不使用本電視機，請將交流電源線從交流電源插座中拔出。

4 捆綁電線

如圖所示，將電線夾插入電視機上的孔中，並把電線放入電線夾內捆綁。

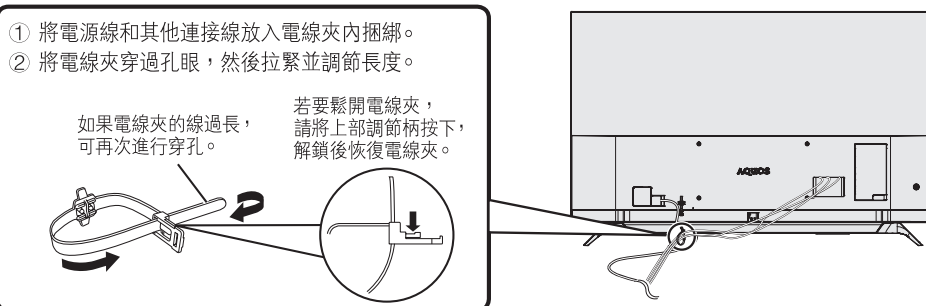

注意

- 為了防止遭受電擊的危險，在連接著電源線時，請不要觸碰接線任何未經絕緣的部份。

準備

連接外部設備

可將許多類型的外部設備連接到電視機上，如數碼電視機機頂盒 (STB)、錄影機、遊戲機、攝錄機、DVD 影碟機和電腦等。要觀看外接源的影像，請按遙控器上的  進入智能界面，左右滑動滑動桿切換至電視界面，選擇您想要進入的輸入源，按下 **OK** 進入。

注意

- 為保護所有的設備，在連接錄影機、遊戲機、攝錄機、DVD 影碟機、數碼電視機機頂盒 (STB)、電腦或其他設備之前，請務必先關閉電視機的電源。
- 在進行連接之前，請仔細閱讀有關的使用說明書 (數碼電視機機頂盒 (STB)、錄影機、DVD 影碟機等)。

■ 當使用HDMI (高清晰度多媒體接口) 連接線時 (市面有售)

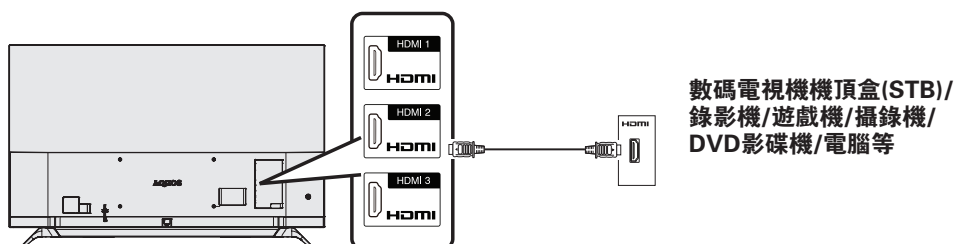

註

- 使用電視機機頂盒觀看電視節目時，請使用機頂盒遙控器切換頻道。

■ 當使用色差連接線時* (市面有售)

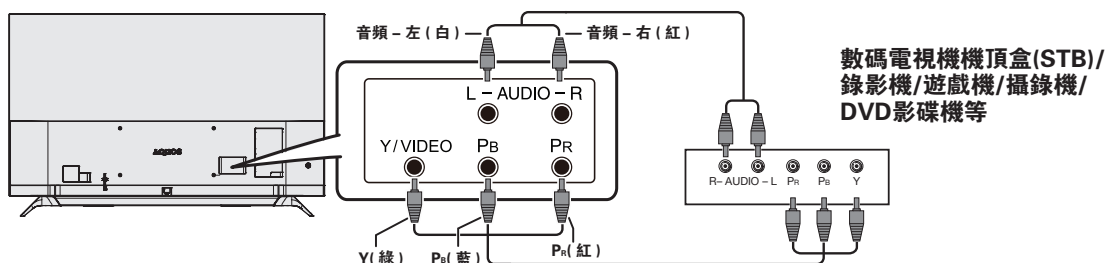

* 色差與影音端子共用。

註

- 請按顏色插入各個端子。

■ 當使用影音連接線時* (市面有售)

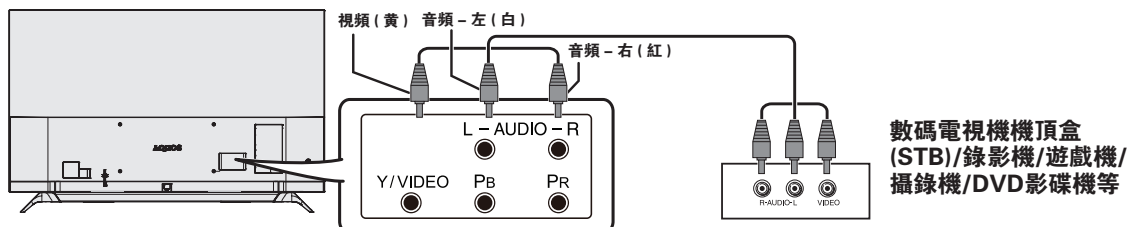

* 色差與影音端子共用。

註

- 請按顏色插入各個端子。

準備

使用數碼音頻輸出

能夠透過 DIGITAL AUDIO OUTPUT (數碼音頻輸出端子) 輸出音頻。從端子輸出 PCM 或 RAW (杜比數碼或 DTS 音頻)。

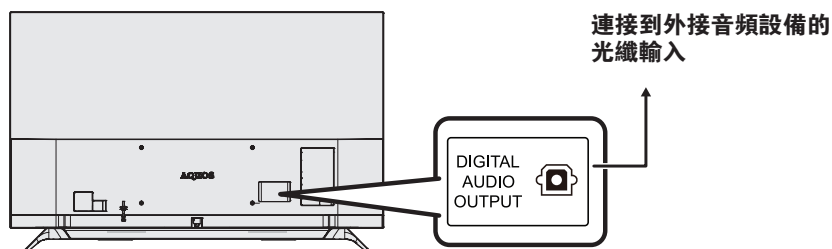

註

- DIGITAL AUDIO OUTPUT (數碼音頻輸出端子) 通常輸出與揚聲器相同的聲音 (正在觀看的節目的聲音從該端子輸出)。
- 由於設備和軟體的不同, DIGITAL AUDIO OUTPUT (數碼音頻輸出端子) 無法輸出某些信號。

插入 Micro SD 記憶卡 (市面有售)

存取、讀取 Micro SD 記憶卡中的影片、音樂等檔案。請將儲存有相關檔案的 Micro SD 記憶卡插入 Micro SD 卡槽。請參閱第 27 頁中, 有關 USB 裝置內的檔案如何播放的說明。

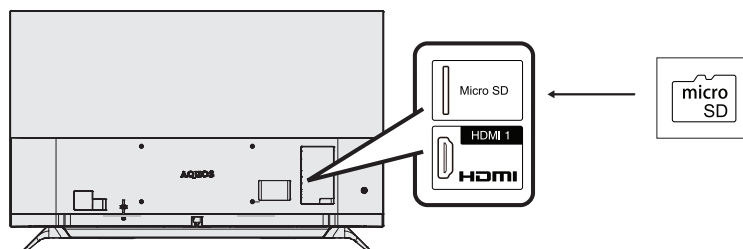

註

- 請按圖示方向將 Micro SD 卡插入卡槽中。
- Micro SD 卡槽支援 SD 及 SDHC 類型的記憶卡, 但部分記憶卡可能無法支援。
- 本產品支援最高 32GB 的記憶卡, 請您盡量選用速度高於 Class4 的記憶卡, 以保證讀寫速度更快, 進而保證系統性能。
- 記憶卡需要在安全移除或關閉電視機後才可取下。
- 記憶卡不得執行熱插拔操作, 否則可能會令電視機故障。
- 請時常為記憶卡內的資料備份, 防止資料損壞或電視機運作錯誤。(若有任何儲存資料損壞或遺失, SHARP 恕不負責)

連接 USB 存儲設備

請參閱第 27 頁。

連接到網絡

請參閱第 24 頁和第 25 頁。

準備

裝入電池

在第一次使用本電視機之前，請插入兩枚“AA”型電池（附送）。當電池耗盡，而且遙控器不能操作時，用新的“AA”型電池替換。

1 打開電池蓋

圖①：一隻手握住遙控器前端，另一隻手拉住手繩的細繩部份。

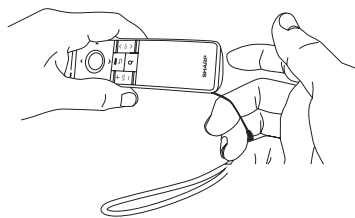

圖②：將大拇指置於底部凹槽處。

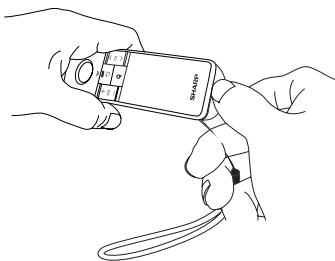

圖③：用中指和食指向內拉手繩，用大拇指沿底部凹槽向外推開電池蓋。

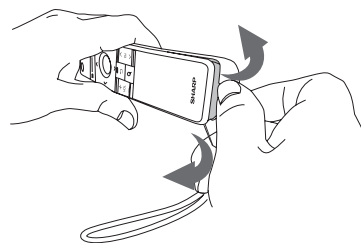

2 插入兩枚附送的“AA”型電池

在裝入電池時，要注意電池端子的極性要與電池艙內的極性標記（+）和（-）一致。

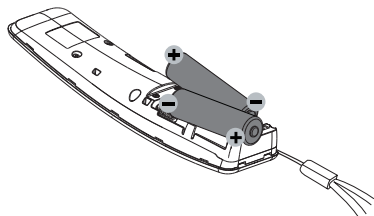

3 關上電池蓋

請把電池蓋由上而下蓋上。

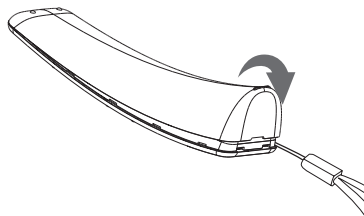

注意

如果電池使用不當，會導致化學物質泄漏或爆炸。請務必遵守如下所述的指示。

- 不要將不同型號的電池混合使用。不同型號的電池具有不同的特性。
- 不要將新舊程度不同的電池混合使用。如果新電池與舊電池混合使用，那麼就會縮短新電池的使用壽命，或導致舊電池的化學物質泄漏。
- 當電池的電量耗盡之時，要立即將電池取出。從電池漏出的化學物質會腐蝕電池艙內零件。如果發現有任何化學物質泄漏，那麼請用布將化學物質徹底擦拭乾淨。
- 由於儲存條件不同，隨同本機附送之電池可能會達不到預期的使用壽命。
- 如果將會長期不使用遙控器，那麼請將電池從遙控器中取出。
- 不要將電池暴露在如直射陽光、火等一些過熱的環境中。

關於遙控器的注意事項

- 切勿使遙控器受到劇烈震動。
此外，切勿將遙控器浸泡於液體之中，或將其置於非常潮濕之處。
- 切勿在直射陽光下設置或放置遙控器。熱力將導致遙控器變形。

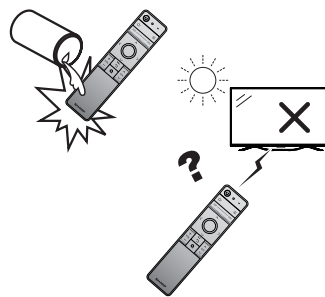

準備

開啟或關閉電視機

首次開啟電視機

電視機接上電源後，進入備用狀態。

按下遙控器或電視機上的 **⏻ (POWER)**：

- 電視機已經開啟。
- 您可以按下遙控器上的 **⏻ (POWER)** 按鍵進入備用模式。

關閉電視機

如在已開啟狀態下，按下遙控器上的 **⏻ (POWER)**：

- 電視機進入備用模式，屏幕上的影像消失。
- 按下遙控器上的 **⏻ (POWER)** 可再次開啟電視機。
- 如在以上備用模式下需要關閉電源，請拔出電視機電源線。

註

- 如果長時間不使用本電視機，請務必將交流電源線插頭從交流電源插座中拔出。
- 即使電視機處於備用狀態，也會略微消耗電量。
- 如遇特殊情況導致電視機突然斷電(如停電或電網波動等)，電視機再次通電後可能工作異常。此時請按下遙控器上的 **⏻ (POWER)** 或拔插電視機電源線來重新啟動電視機。
- 在觀看電視過程中，電視機溫度會升高，此為正常現象。
- 在電視機開啟、關閉過程中，運行應用程式或系統升級過程中，請勿隨意切斷電源，否則可能造成電視機故障。如需關閉電視機電源，請關閉所有應用程式，並正常關閉電視機後再關閉電視機電源。

用戶指南

購買電視機之後，當首次開啟電源時，就會顯示出開始設置的嚮導。請按照選項表所示，一步一步地進行所需的設置。

在開啟電源之前，請先確認以下事項。

- 是否已連接天線？
- 是否已將電源插頭插入電源插座？

按下電視上的 **⏻ (POWER) 按鈕。**

- 顯示開機畫面，之後顯示“語言設置”畫面。
- 第一次開機時間較長，請耐心等待。



語言設置

可以將電視語言設置為“繁體中文”、“簡體中文”或“EN”。

開始設置

開始設置，按步驟設置電視機。

模式設置

如您是在家裡觀看電視，建議選擇“家居模式”。

- “家居模式”：“影音模式”設置的預設值為“標準”。
- “商店模式”：僅商店展示時使用。“影音模式”設置的預設值為“動態(固定)”。“影音模式”改變後，10分鐘內若未繼續設置電視機，則電視機會自動切換回“動態(固定)”。

頻道設置

電視機會根據其設置和連接的天線搜索、分類和儲存所有能接收的電視台。

網絡設置

您可以選擇“有線連接”或“無線連接”方式接入到網絡。請參閱第 24 頁和第 25 頁。

觀看電視

當初始設置完成後，即可進入電視的主頁面。按下遙控器的◀/▶按鍵，或者左右滑動 SLIDE BAR，即可在不同界面切換。如想觀看傳統電視節目，請切換至電視界面，按▲/▼/◀/▶選擇模擬電視/數碼電視或您的機頂盒所在的輸入源，然後按下OK，電視螢幕開始播放選擇的節目或輸入源。按◀/▶移動到螢幕上的節目後按下OK，便可以全屏播放節目。

選項表

聲音切換

在觀看多音頻或立體聲廣播節目時，可切換多種音頻模式。

在麗音電視廣播模式下

訊號	切換模式
立體聲	麗音 立體聲、單聲道
雙語	麗音 頻道 A、麗音 頻道 B、麗音 頻道 AB、單聲道
單聲道	麗音 單聲道、單聲道

在 A2 電視廣播的電視模式下

訊號	切換模式
立體聲	立體聲、單聲道
雙語	頻道 A、頻道 B、頻道 AB
單聲道	單聲道

- 1 在電視全屏播放電視節目時按下 三 (選項表) 鍵，顯示功能表畫面。
- 2 按下 ▲/▼，選擇“聲音切換”，然後按下 OK (輸入)。
- 3 按下 ◀/▶，按下 OK (輸入) 來選擇所需的聲音。

註

- 僅在模擬電視 (ATV) 下可選擇聲音切換。

音頻語言

當播放數碼電視 (DTV) 節目時可切換多種音頻語言。

- 1 在電視全屏播放電視節目時按下 三 (選項表) 鍵，顯示功能表畫面。
- 2 按下 ▲/▼，選擇“音頻語言”，然後按下 OK (輸入)。
- 3 按下 ▲/▼ 來選擇所需的聲音，然後按下 OK (輸入)。

字幕語言

當廣播中含有字幕資訊時，您可以在此切換字幕語言。

- 1 在電視全屏播放電視節目時按下 三 (選項表) 鍵，顯示功能表畫面。

- 2 按下 ▲/▼，選擇“字幕語言”，然後按下 OK (輸入)。

- 3 按下 ▲/▼ 來選擇所需的字幕語言，然後按下 OK (輸入)。

回看

您可以在當前選擇的輸入源 / 頻道和前一個輸入源 / 頻道之間進行切換。

- 1 在電視全屏播放電視節目或外部輸入源節目時按下 三 (選項表) 鍵，顯示功能表畫面。
- 2 按下 ▲/▼，選擇“回看”，然後按下 OK。
- 3 再次按以上 1、2 步驟操作，可返回到當前的頻道或輸入源。

信息

顯示節目資訊，僅適用於數碼電視。

- 1 在電視全屏播放電視節目時按下 三 (選項表) 鍵，顯示功能表畫面。
- 2 按下 ▲/▼，選擇“信息”，然後按下 OK。

EPG

電子節目指南是與數碼電視 (DTV) 一起被廣播的。利用電子節目指南，您可查看數碼電視 (DTV) 的節目安排及其詳細資訊。

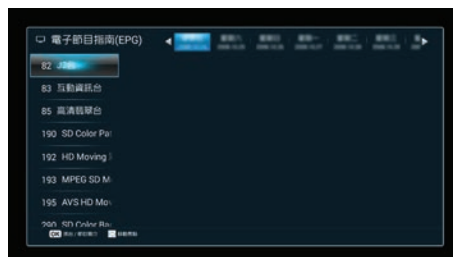

- 1 在電視全屏播放電視節目時按下 三 (選項表) 鍵，顯示功能表畫面。
- 2 按下 ▲/▼，選擇“EPG”，然後按下 OK，可顯示電子節目指南。

註

- EPG 顯示的時間為電視台發送的訊息。

頻道列表

顯示頻道資訊。

- 1 在電視全屏播放電視節目時按下 三 (選項表) 鍵，顯示功能表畫面。
- 2 按下 ▲/▼，選擇“頻道列表”，然後按下 OK (輸入)。
- 3 按下 ▲/▼ 選擇您想要觀看的頻道，並按下 OK。

觀看電視

頻道編輯

可手動設置某些頻道項目。

- 1 在電視全屏播放電視節目時按下 **三** (**選項表**) 鍵，顯示功能表畫面。
- 2 按下 **▲/▼**，來選擇“頻道編輯”，然後按下 **OK** (輸入)，顯示頻道列表。
- 3 按下 **▲/▼**，來選擇所需的頻道。

■ 標籤

可更改各個頻道的名稱。

- 1 按下 **◀/▶**，選擇“標籤”，按下 **OK**。
- 2 按下 **▲/▼/◀/▶/OK** 選擇字元，直到名稱的字元全部拼出來，然後按下遙控器上的 **↶** (**返回**) 保存並且退出。

📎 註

- 名稱的字元最多為 8 個。
- 只有 ATV 下的頻道可更改標籤。

■ 排序

頻道位置可以自由地進行排序。

- 1 按下 **◀/▶**，選擇“排序”，按下 **OK**。
- 2 按下 **▲/▼**，將該頻道移動到所需的位置，然後按下 **OK** (輸入)。
- 3 重複上述操作直到完成所有頻道的排序。

■ 跳越

在觀看電視節目時，如果用 **CH ▲/▼** (**頻道 ▲/▼**) 選擇了被設置為“跳越”的頻道，該頻道就會被直接跳過。

- 1 按下 **◀/▶**，選擇“跳越”，按下 **OK** (輸入)，當前頻道即設置成“跳越”。
- 2 若再次選擇“跳越”，並按下 **OK** (輸入)，可取消第一步驟設置的跳越。

■ 刪除

可以刪除各個頻道。

按下 **◀/▶**，選擇“刪除”，按下 **OK** (輸入)，選擇“是”，然後按下 **OK** (輸入)，可刪除選擇的頻道。

數字鍵盤

可按下 **▲/▼/◀/▶/OK** 輸入頻道號碼，來選擇您想要觀看的頻道。

HDMI選擇

當您連接外部設備輸出 4K (60Hz) 信號時，請使用 HDMI3 端子連接，並選擇“4K (60Hz)”。

- 1 在電視全屏播放 HDMI3 訊號時按下 **三** (**選項表**)，顯示功能表畫面。
- 2 按下 **▲/▼**，選擇“HDMI 選擇”為“4K(60Hz)”，然後按下 **OK** (輸入)。

電腦顯示模式

僅在 HDMI 輸入端口時可選擇電腦顯示模式。開啟後更適合顯示電腦圖像的文字內容。

📎 註

- 電腦顯示模式適用於接駁電腦時。

設置

可根據您的需求設置選項表。

一般設置



主題

您可以在此更換智能界面的主題模式。可供選擇的有：清新格調、繽紛炫彩。

開機狀態

設置開機狀態。兩種狀態可供選擇：電視或智能界面。

📎 註

- “電視”：開機後進入電視界面。
- “智能界面”：開機後進入智能界面。

語言設置

您可以設置系統的語言。三種語言可供選擇：英文、繁體中文或簡體中文。

預設輸入法

輸入法的設定。

📎 註

- 電視機初始安裝“IQQI-International”。
- 對於非本機初始安裝的輸入法，不保證其與電視系統的兼容性。

滑鼠速度

設置遙控器滑鼠的靈敏度。可供選擇：“高”、“中”或“低”。

無訊號自動關機

可將電視機設定為在接收不到節目的訊號後約 15 分鐘時自動關閉電源。

📎 註

- 在電源關閉之前的 5 分鐘，每隔一分鐘會顯示一次剩餘時間。

觀看電視

定時關機

在指定的時間自動關閉電視機。
可選擇的有：“關”、“30 分鐘”、“60 分鐘”、“90 分鐘”、“120 分鐘”或“150 分鐘”。

註

- 在設定了時間後，倒計時自動開始。
- 在到達預設時間之前 5 分鐘開始，每分鐘會顯示一次剩餘時間。

待機指示燈

您可以對待機指示燈進行設置。
可供選擇的有：“開”或“關”。

開機音效

您可以對開機音效進行設置。
可供選擇的有“開”或“關”。

影像

您可根據個人喜好對影像進行調整。



影音模式

用“影音模式”功能可選擇適合於電視顯示器環境的音頻和視頻設定。

所選擇的項目	說明
標準	在一般照明度的房間中以獲得高清晰度的影像。
電影	用於電影。
遊戲	降低圖像的亮度使觀看時更加舒適。
用戶	可以根據使用者的需要進行設置。可以為每個輸入源設置模式。
動態	用於觀看體育運動場景以獲得較高對比度的清晰的影像。
動態 (固定)	將影像和聲音的設置恢復到出廠時的預設值。沒有可允許的調校。

註

- 對於每一個輸入模式，可選擇不同的影音模式項目。

對比度/亮度/色調/銳度/色彩/背光/伽瑪校正

可將影像調整到適合自己的喜好。

所選擇的項目	◀ 按鈕	▶ 按鈕
對比度	減弱對比度	增強對比度
亮度	減弱亮度	增強亮度
色調	使皮膚色調略帶紫色	使皮膚色調略帶綠色
銳度	減弱清晰度	增強清晰度
色彩	減弱色彩強度	增強色彩強度
背光	畫面變暗	畫面變亮
伽瑪校正	減弱中間級別亮度	增強中間級別亮度

色溫

調校色溫以得到最佳的白色平衡。
可供選擇的有：“高”、“中 - 高”、“中”、“中 - 低”或“低”。

寬屏模式

可以為每一種影像選擇不同的屏幕模式。

所選擇的項目	說明
標準	用於 4:3 標準影像。左右兩側都出現一個邊緣條。
14:9 縮放	用於 14:9 的信箱型影像。左右兩側出現一個狹窄的邊緣條，並且在某些節目情況下可以看見頂部和底部也出現邊緣條。
全景	在這種模式下，影像被一步步拉開到屏幕的兩側邊緣。
全屏	用於 16:9 擠壓型影像。
16:9 影院	用於 16:9 信箱型影像。在某些節目時頂部和底部可能出現邊緣條。
14:9 影院	用於 14:9 信箱型影像。在某些節目時頂部和底部可能出現邊緣條。
逐點	在畫面上顯示同樣像素數目的影像（只適用於接收 2160p 訊號時）。
優化掃描	僅在接收 720p/1080i/1080p 訊號時顯示“優化掃描”影像。顯示高解像度影像時調節到最佳。對於某些節目，畫面邊緣可能會出現雜波。

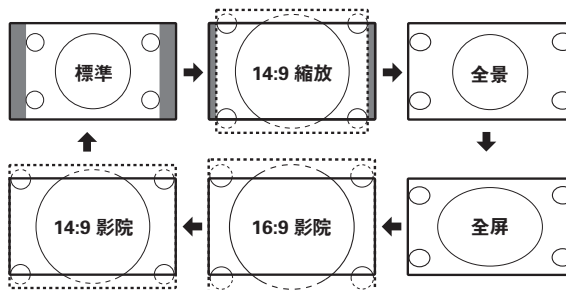

註

- 由於輸入訊號各有不同，有可能不會顯示某些影像尺寸。
- “14:9 縮放”和“14:9 影院”僅在 ATV (模擬電視) 或 DTV (數碼電視) 模式下有效。

觀看電視

圖像抑噪

減少畫面上的噪點，再現更加清晰的視頻影像。
可供選擇的有：“自動”、“高”、“低”或“關”。

動態對比度

根據畫面自動調節影像的對比度。

Fine Motion

使用“Fine Motion”功能可更清晰地觀賞高速運動的影像。

可供選擇的有：“增強”、“標準”或“關”。

註

- 僅適用於 24/30Hz 的輸入信號。

智能對比度

本功能將背光源進行精細分割，並以像素為單位分割影像，自動計算被拍攝物體的亮度資訊，重新構建畫面亮度，增強光線的散佈效率，提升畫面亮度。使明亮部分色彩艷麗，黑暗部分濃郁深邃。

可供選擇的項目有：“高”、“中 - 高”、“中”、“低”或“關”。

所選擇的項目	說明
高 中 - 高 中 低	檢測出圖像以像素為單位的明暗區域，通過精細的圖像控制和背光控制以 4 個等級來顯示亮度。
關	關閉此功能。

HDR 伽瑪校正

用於調整 HDR 訊號輸入時的圖像。值變大，重視的是亮度，值變小，重視的是對比度。

還原

將所有的圖像調校項目重新設定為出廠預設值。

音頻

您可根據個人喜好對音頻進行調整。



影音模式

請參閱第 20 頁。

自動音量

不同的聲音來源有時音量也不同，如節目及插播的廣告時段。自動音量控制（自動音量）可通過平衡音量解決這個問題。

低音/高音/平衡

可以調整所選擇的影音模式的音頻。

所選擇的項目	◀ 按鈕	▶ 按鈕
高音	減弱高音	增強高音
低音	減弱低音	增強低音
平衡	減弱右邊音箱的聲音	減弱左邊音箱的聲音

註

- 在“動態（固定）”模式下，不能進行音頻調整。

環繞聲

環繞聲功能從揚聲器產生出環繞聲效果。

音頻輸出

用該功能可選擇自己喜歡的音頻輸出制式。

所選擇的項目	說明
PCM16	光學輸出格式通常為 PCM 格式。
RAW	當接收到杜比數碼或 DTS 音頻格式時就會輸出杜比數碼或 DTS 音頻。

註

- 即使選擇了“RAW”，模擬音頻和視頻輸入音頻仍然按 PCM 格式輸出。
- 即使選擇了“RAW”，PCM 輸入信號仍然按 PCM 格式輸出。

還原

將所有的音頻調校項目重新設定為出廠預設值。

觀看電視

頻道設置

您可根據個人喜好對頻道進行設置。



執行自動頻道搜尋

即使設置預置頻道之後，您也可以再進行自動安裝。



- 執行自動頻道搜尋只能搜尋當前模式下的頻道。

數碼頻道設置

可手動設置某些數碼頻道項目。

■ 執行自動頻道搜尋

完成自動安裝後，使用本選項表以便自動新增數碼頻道服務。

■ 執行手動頻道搜尋

在指定頻寬或指定頻道號碼內新增頻道服務。

■ 訊號資訊

顯示當前節目的“頻道”、“頻率”、“訊號強度”和“訊號品質”訊息。



- “訊號強度”和“訊號品質”是表示檢查天線相應訊號接收的值。

模擬頻道設置

可手動設置某些模擬頻道項目。

■ 執行自動頻道搜尋

完成自動安裝後，使用本選項表以便自動新增模擬頻道服務。

■ 執行手動頻道搜尋

可手動設置頻道項目。

所選擇的項目	說明
儲存頻道 [1~99]	將當前節目保存至您想要的頻道，按 OK(輸入) 鍵儲存。
現時頻道	選擇您想要手動調節的頻道。
彩色制式	選擇最佳的彩色制式接收。(PAL, SECAM, NTSC)。
聲音制式	選擇最佳的聲音制式(廣播制式)接收。(BG, DK, I, MN)。
搜尋	從當前頻道開始搜索，按照順序調整頻率搜尋下一個頻道。
微調	對當前的頻道進行頻率的微調優化。

頻道編輯

請參閱第 19 頁。

網絡

請參閱第 24 頁和第 25 頁。

應用程式

請參閱第 26 頁。

觀看電視

選項

對其他電視項目的設置。



數碼音頻語言

設置首選多音頻語言，在提供音頻語言時播放。

註

- 本功能視乎電視台的音頻語言資訊而定。
- 若接收到的廣播訊號中不包含所選語言的音頻，那麼就不會輸出該語言的音頻。

字幕

當廣播中含有字幕資訊時，可以在此設置。

註

- 若接收到的廣播訊號中不包含所選語言的字幕，該語言的字幕是不會顯示出來。

適用於聽力障礙者

如果廣播中包含了用於聽覺障礙者的字幕，那麼該字幕就比其他字幕優先顯示出來。

註

- 如果廣播中沒有包含用於聽覺障礙者的字幕，那麼即使設置為“開”也不會顯示字幕。
- 僅在數碼電視（DTV）下可進入選項設置。

系統

查看和設置系統相關的訊息。

系統訊息

查看系統的硬件訊息和軟件訊息。

法律訊息

查看開放源代碼許可訊息。

本地更新

利用此功能可透過 USB 設備將軟件更新到最新版本。

註

- 若數據與系統不相容，則畫面上會出現一個錯誤訊息。按下 **OK (輸入)** 之後，請重複進入一般設置→系統→本地更新進行操作。
- 若顯示出錯誤訊息，則請檢查：
 - USB 設備是否已可靠地插入。
 - USB 設備中有 2 個或更多的軟件更新文件。
 - USB 存儲器中沒有用於更新系統的數據。
 - 軟件更新文件已損壞。
 - 軟件更新文件與電視機的軟件不兼容。
- 更新時，請不要切斷電視機電源或進行其他操作。

系統還原

如果經過了複雜的調校之後，設置不能夠恢復到正常狀態，那麼請將設置還原到出廠時的預設值。

網絡功能

連接到網絡

想要享受互聯網服務，那麼就需要用高速連接到互聯網的方式將電視機連接到路由器。

註

- 如果不具備寬頻互聯網連接條件，那麼請諮詢您購買電視機的商店或詢問您的互聯網服務供應商或電話公司。
- 播放串流媒體內容需要有穩定的連接速度，否則可能無法正常觀看。

有線安裝準備

開啟路由器（市面有售）電源，如下圖所示用LAN接線（市面有售）將電視機上的LAN端子連接到您的路由器。

- 路由器的使用方法請參閱其使用說明書。

有線連接概覽圖

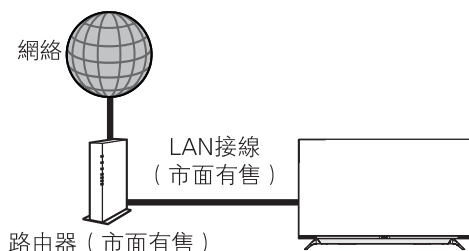

如何連接



無線安裝準備

開啟路由器（市面有售）電源，如下圖所示用無線方式將電視機連接到您的路由器。

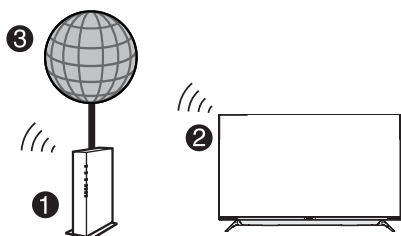

- ① 無線區域網路路由器 / 接入點
- ② 電視機
- ③ 網絡

註

- 本電視機具有以下認證。
 - Wi-Fi CERTIFIED™ (Wi-Fi 聯盟的認證手續)
- 並非在所有的居住環境下都能保證有無線區域網連接並保證其性能。在以下情況下，無線區域網信號可能很差或衰落，或其連接速度可能變得較慢。
 - 在混凝土、有加固鋼筋、或金屬結構的建築物中使用時
 - 放置在能阻隔信號的物體附近時
 - 在與其他輻射相同頻率的無線設備一起使用時
 - 在微波爐和其他輻射磁場、靜電或電磁干擾的設備附近使用時
- 請確認您的網絡中的防火牆允許訪問到電視機的無線連接。
- 當使用未經 Wi-Fi® 認證的接入點時，不能保證可正常運行。
- 在使用無線區域網時，需要有一個無線區域網接入點來將電視機連接到互聯網。設置方法請參閱您的接入點的使用說明書。
- 播放串流媒體內容需要穩定的連接速度。如果無線區域網的速度不穩定，那麼請使用有線連接。
- 由於網絡上格式眾多，某些格式本電視機可能無法播放。
- 在轉換到第三方或更改配置之前，請務必先進行無線區域網設置的初始化。

網絡功能

網絡設置

選擇選項表的“設置”，然後按下**OK**（輸入），按下▲/▼，選擇“網絡”選項，然後按下**OK**（輸入），螢幕顯示當前網絡訊息。



有線網絡連接

使用有線連接方式接入到網絡。

■ 自動連接

系統會嘗試自動獲取 IP 位址等相關資訊。

■ 手動連接

根據頁面提示輸入對應的 IP 地址、子網絡遮罩、預設網關、首選 DNS 服務器、備用 DNS 服務器。

無線網絡連接

使用無線連接方式接入到網絡。

將“是否啟用無線網絡連接”設置為“開”後，螢幕顯示當前附近的無線網絡訊息。

如當前無線網絡連接安全性為不開放，按下**OK**，調出輸入法後輸入密碼。

📎 註

- 如果您想要在有線網絡和無線網絡之間替換使用時，需要您每次手動打開選項表→網絡進行切換。

■ 添加網絡

您可以手動添加一個不廣播的無線網絡。

根據螢幕提示輸入不廣播的無線網絡資訊後選擇“儲存”，即可添加當前無線網絡。

藍牙設置

選擇“藍牙設置”並按下**OK**，顯示正在掃描設備。

可在此選擇重新整理。

連接藍牙設備的具體操作請參閱螢幕提示進行。

📎 註

- 視乎使用的設備而定，藍牙設備可能無法正常運作。

智能功能

智能電視搭載安卓平台，大量第三方應用隨心下載使用。

按下 ，顯示智能界面。

智能界面

智能界面將電視節目、應用程式等整合其中，為您呈現最直接方便的智能操作界面。

您可以在電視和應用等界面自由切換，按下 **OK**（輸入）進入具體內容。

電視界面

選擇一個輸入源（模擬電視、數碼電視、HDMI1、HDMI2、HDMI3、色差、AV），然後按下遙控器上的 **OK**（輸入）進入。

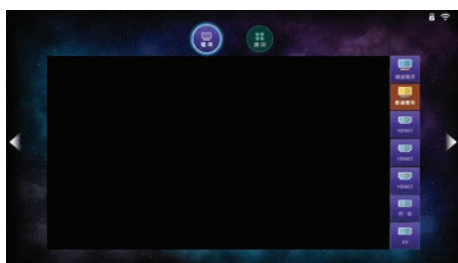

應用界面

為您提供大量應用，給您更豐富更精彩的應用體驗。

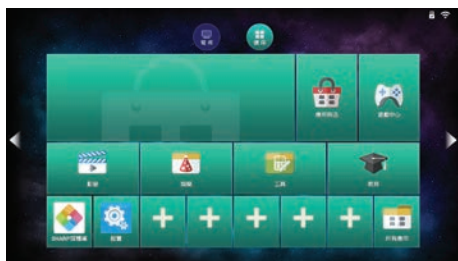

在應用界面，您既可以直接體驗隨機安裝的應用，也可以從應用商店下載更多的應用。

無法保證所有應用軟體能夠正確讀取產品資訊。

安裝應用

進入“應用商店”，選擇您想安裝的應用，根據螢幕提示將應用安裝到電視上。

應用程式

您可管理已經下載到電視的應用。

1 在應用界面選擇“設置”選項，然後按下 **OK**。

2 按下 **▲/▼**，選擇“應用程式”，然後按下 **OK**（輸入）。按下 **▲/▼**，選擇您想要設置的項目，然後按下 **OK**。

■ 內置儲存空間

可查看電視內部未使用和總儲存空間。

■ 顯示SD卡儲存空間

可查看 SD 卡內未使用和總儲存空間。

■ 允許未知來源

設置是否允許未知安全來源的應用。

■ 首選安裝位置

設置首選安裝位置，可選擇“預設”、“內置儲存”和“外置儲存”。

■ 我的應用

顯示已安裝的應用列表，可對應用“強制停止”、“卸載”、“清除緩存”或“移至 SD 卡 / 移至內部儲存”。

註

- 在使用兒童模式應用時，如忘記密碼，請在密碼輸入畫面上輸入“3001”後進入，重置密碼後進行其它操作。

■ SD卡格式化

格式化 Micro SD 卡槽中的存儲卡。

註

- 選擇 SD 卡格式化將導致當前存儲或安裝在 Micro SD 卡上的內容被完全刪除，已經刪除的內容或應用不可恢復，請謹慎操作。

■ SD卡安全卸載

請在拔出 Micro SD 卡槽中的存儲卡之前，進行安全卸載操作。

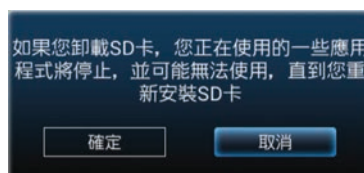

註

- 記憶卡不得執行熱插拔操作，否則可能會令電視機故障。
- 記憶卡需要在安全移除或關閉電視機後才可取下。
- 請時常為記憶卡內的資料備份，防止資料損壞或電視機運作錯誤。（若有任何儲存資料損壞或遺失，SHARP 不負責）

輸入文字

在需要輸入字元時，按下 **OK**（輸入），虛擬鍵盤就會顯示在螢幕上。

提供虛擬鍵盤輸入模式。輸入過程中，您可根據螢幕提示游標選擇字母，按下 **OK**（輸入）後則完成字元輸入。同時可根據虛擬鍵盤的提示來切換中文輸入、英文輸入和數位輸入等模式。

瀏覽器

在應用界面，選擇“瀏覽器”，然後按下 **OK**（輸入）即可進入。您也可以按下遙控器上的 **Q**（瀏覽器），快速進入瀏覽器界面。

其他有用功能

可將 USB 存儲設備或 USB 硬碟驅動器連接到電視機來觀賞相片、聆聽音樂並觀看影片。

註

- 由於 USB 存儲設備各有不同，電視機可能不能夠識別所記錄的數據。
- 如果 USB 存儲設備中存儲了許多文件或文件夾，那麼讀取所記錄的數據可能需要花費相當長的時間。
- 有可能不支援某些視頻文件中的外掛字幕。

連接 USB 存儲設備

將記錄著相片、音樂或影片的 USB 存儲設備插入到電視機上的 USB1 或 USB2 端子。

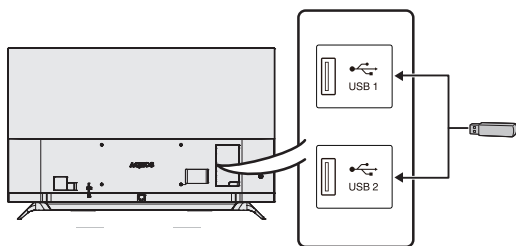

- USB1 和 USB2 端子不可同時連接硬碟驅動器。
- 在連接 USB 硬碟驅動器時，請務必使用具有交流電源適配器的硬碟驅動器。
- 正在傳輸文件時，請勿從電視機上卸下存儲設備。
- 請勿將 USB 存儲設備 /USB 硬碟驅動器反覆插入和從電視機上拔出。
- 在使用讀卡器時，請務必在使用讀卡器之前先插入存儲卡。
- 電視機可能會無法識別讀卡器。
- 當電視正在播放 USB 設備中的數據時，請遵守以下事項：
 - 請勿關閉電視機。
 - 請勿斷開 USB 電線連接。
 - 請勿拔出、移動 USB 設備，如需拔出請先退出 USB 界面，否則可能造成數據丟失，USB 設備損壞或電視系統故障無法正常運行。
- 當連接 USB 集線器時，電視機可能不能夠識別所有的 USB 存儲設備。

注意

- 請勿使用 USB 延長連接線將 USB 存儲設備連接到電視機的 USB 端子上，否則可能會妨礙電視機正常工作。
- 請打開電視機後再插入 USB 存儲設備。

播放 USB 存儲設備中的檔案



- 1 按下遙控器上的 進入智能界面，滑動 SLIDEBAR，切換至應用界面，選擇“SHARP 媒體庫”，然後按下 **OK (輸入)** 進入。
- 2 按下 ，選擇您要進入的設備或驅動器。
- 3 按下 ，選擇所需的文件、相片、音樂或影片，然後按下 **OK (輸入)**。選擇您想要播放的文件，然後按下 **OK (輸入)**，即可播放當前文件。
 - 按下遙控器上的 (**返回**) 鍵，可以進入上一層文件夾。
- 4 觀看相片、影片時按 (**選項表**) 可顯示 USB 多媒體選項表畫面。通過按 選擇相關功能，然後按 **OK (輸入)** 進行操作。詳細功能與其適用的模式請參閱第 28 頁的表格。

其他有用功能

用於USB多媒體選項表操作的按鈕

按鈕/選項表	說明	影片模式	音樂模式	相片模式
	播放/ 暫停。	✓	✓	-
	轉至上一個文件。	-	✓	-
	轉至下一個文件。	-	✓	-
	循環播放。 每次按下OK(輸入)在“順序播放”、“循環播放所有”、“單曲播放”、“循環播放單曲”、“隨機播放”之間切換。	-	✓	-
	播放列表。 顯示播放列表，可以從播放列表中選擇播放文件。	-	✓	-
 縮放	按CH^/∨切換相片大小，按▲/▼/◀/▶鍵移動。	-	-	✓
 旋轉	旋轉相片 按◀/▲逆時針旋轉；按▶/▼順時針旋轉； 按↶(返回)鍵退出。	-	-	✓
 幻燈片	幻燈片播放選項 選擇幻燈片播放時的間隔時間、切換模式。	-	-	✓
 電視設置	設置電視選項	✓	✓	✓
 字幕選項	視頻播放時設置字幕 可進行字幕顯示、字幕選擇、字幕切換、字幕搜索、字幕高級設定的設置。	✓	-	-
 音頻選項	視頻播放時選擇音軌。	✓	-	-
 跳越時間	指定播放起點 從輸入的時間開始播放。	✓	-	-
 高級選項	播放設置 視頻播放時：設置中斷點播放、快進快退、單循環。	✓	-	-
	按OK(輸入)鍵播放上一個文件。	✓	-	-
	按OK(輸入)鍵播放下一個文件。	✓	-	-
快進	按▶鍵快進。	✓	✓	-
快退	按◀鍵快退。	✓	✓	-
	播放上一個文件。	-	-	✓
	播放下一個文件。	-	-	✓

其他有用功能

與 USB 模式相容的檔案列表

支援的視頻格式

文件擴展名	視頻編碼	音頻編碼	字幕
avi	MPEG2 MP@HL MPEG4 SP@L0-3,ASP@L-05 MPEG4 ASP(GMC 0,1p) H.264 HP@Up to Level 4.0 H.264 MP@L 4.0 H.265(HEVC) Main Profile @ Up to Level 5 (4k2k 30 fps) H.265(HEVC) Main Profile @ Up to Level 5.1 (4k2k 60 fps) MPEG4 ASP@Level 5 H.264 HP@Up to Level 5.1 H.264 HP@Up to Level 4.1 H.264 (AVC) MP@L 4.1	PCM AC3 WMA,WMA Pro MP3 AAC,support MPEG2 AAC(AAC-LC) & MPEG4 AAC-LC HE-AAC,support MPEG4 HE-AAC v2 MPEG Audio,support MPEG1 Layer 1/2 Dolby Digital Plus Dolby Digital DTS	外部: MicroDVD SRT SSA ASS Subview Vobsub 內部: Vobsub
mkv	MPEG1 MP MPEG2 MP@HL MPEG-4 SP@HL 3.0 & MPEG-4 ASP@HL 4.0 H.264 HP@Up to Level 5.1 H.264 HP@Up to Level 4.1 H.265(HEVC) High/Main Profile @ Up to Level 5 (4k2k 30 fps) H.265(HEVC) High/Main Profile @ Up to Level 5.1 (4k2k 60 fps) MPEG1 MPEG4 SP MPEG4 ASP @Level 5 H.264 (AVC) MP@L 4.1	AAC(AAC-LC)(H 264) AC3 Dolby Digital Plus Dolby Digital DTS	外部: MicroDVD SRT SSA ASS Subview Vobsub 內部: SSA ASS SRT Vobsub
ts	MPEG2 MP@HL H.264 High profile to level 5.1 H.264 Main profile to level 4.1 H.264 baseline profile to level 4.0 H.264 HP@Up to Level 4.1 H.264(AVC) MP@L4.1 H.264(AVC) BP@L3.1 H.265(HEVC) Main Profile @ Up to Level 5 (4k2k 30 fps) H.265(HEVC) Main Profile @ Up to Level 5.1 (4k2k 60 fps)	MPEG Audio,support MPEG1 Layer 1/2 & MP3(MPEG2) LPCM Dolby Digital Plus Dolby Digital AC3 MP3 DTS AAC	-
trp	MPEG2 MP@HL H.264 HP@Up to Level 4.1 H.264(AVC) MP@L4.1	MP3	-
tp	MPEG2 MP@HL	MP3	-
m2ts	MPEG2 MP@HL H.264(AVC) MP@L4.0 H.264(AVC) BP@L4.0 H.265(HEVC) Main Profile @ Up to Level 5 (4k2k 30 fps) H.265(HEVC) Main Profile @ Up to Level 5.1 (4k2k 60 fps)	AC3 AAC Dolby Digital	-
vob mpeg	MPEG1 MPEG2 MP@HL	LPCM Dolby Digital Dolby Digital Plus	-
dat	MPEG1 MPEG2	MP3	-
mov	MPEG4 SP MPEG2 MP@HL MJEPG H.264 HP@Up to Level 5.1 H.264 HP@Up to Level 4.1	Dolby Digital Plus Dolby Digital	-
flv	H.264 HP10 LV 4.0 H.264 MP10 LV 4.0 H.264 BP LV 4.0 (**2) H.264 HP@Up to Level 5.1 H.264 HP@Up to Level 4.1 MPEG4 SP MPEG4 ASP@Level 5 H.264(AVC) MP@L4.1	MPEG4 AAC-LC MPEG1 Layer 1/2	外部: MicroDVD SRT SSA ASS Subview Vobsub

其他有用功能

文件擴展名	視頻編碼	音頻編碼	字幕
mp4	MPEG2 MP@HL MPEG4 SP MPEG4 ASP@Level 5 MPEG-4 SP@HL 3.0 & MPEG-4 ASP@HL 4.0 H.264 HP@Up to Level 5.1 H.264 HP@Up to Level 4.1 H.264(AVC) MP@L4.0 H.264(AVC) BP@L4.0 H.265(HEVC) Main Profile @ Up to Level 5 (4k2k 30 fps) H.265(HEVC) Main Profile @ Up to Level 5.1 (4k2k 60 fps)	MPEG1 Layer 1/2 Dolby Digital Plus Dolby Digital MPEG4 (AAC) AAC HE-AAC (AAC+) HE-AAC v2 (enhanced AAC+) MPEG4 (Enhanced Low Delay AAC)	外部: MicroDVD SRT SSA ASS Subview Vobsub
3gp	MPEG2 MP@HL MPEG-4 SP@HL 3.0 & MPEG-4 ASP@HL 5.0 H.264 HP@Up to Level 5.1 H.264 HP@Up to Level 4.1 H.264(AVC) MP@L4.0 H.264(AVC) BP@L4.0 H.263	MPEG1 Layer 1/2 AMR_NB AAC	外部: MicroDVD SRT SSA ASS Subview Vobsub
rmvb	Real Video 8, 9, 10	-	-
webm	VP8	-	-
DTMB	AVS:Full-HD 60P decoderJizhun profile @ Level 6.2 (supports 4:2:0 format),Full-HD 60P decoder MPEG2 MP@HL H.264 HP@Up to Level 5.1 H.264(AVC) MP@L4.0 H.264(AVC) BP@L4.0	Dolby Digital Plus Dolby Digital MPEG1 Layer 1/2 (MPEG2) MPEG2 (AAC-LC) (H.264) & MPEG4 AAC-LC (H.264) DRA(解碼)	-

■ 支援的音頻格式

文件擴展名	音頻編碼
mp3	MPEG1 Layer 1/2/3
wma	WMA、WMAPro、WMA V9
flac	flac
ogg	VORBIS
wav	WAVE、PCM
mka	AC3
aac	AAC
m4a	AAC
mid	MIDI

■ 支援的圖片格式

文件擴展名	圖片編碼
JPEG	progressive 4000*4000 baseline 8000*8000
PNG	4096*5760
GIF	8000*8000
BMP	8000*8000

📎 註

- USB 1.1 設備中的文件可能無法正確播放。
- 不保證可以使用 USB 集線器。
- 可能無法正確播放高於 1280x720 的 Motion jpeg 視頻。
- 上述列表中某些文件格式可能無法正常播放 (包括圖像、聲音、字幕等)。
- 視比特率而定, 某些文件可能無法播放。
- 支援的是 DTS 編碼的視頻文件, 並不是 DTS 環繞聲。
- 某些字幕可能無法正確顯示, 並可能影響電視機的正常運作。
- 僅顯示相容的文件格式。
- 根據文件不同, 顯示的播放時間可能會與實際播放時間稍有不同。
- 部分文件時間長度資訊可能無法正確顯示。

附錄

故障分析

下述問題並非一定由於故障而引起。在請人修理電視機之前，請再次檢查電視機。

故障	可能的解決方案
<ul style="list-style-type: none">沒有電源。	<ul style="list-style-type: none">交流電源線是否沒有連接？（請參閱第 13 頁。）主電源是否被開啟？（請參閱第 17 頁。）若電源開關不起作用，請拔出電源插頭然後再將電源插頭插入，等待 5 秒鐘以上，然後再按下電視機上的 ⏻（POWER）。
<ul style="list-style-type: none">不能操作本機。	<ul style="list-style-type: none">外來的影響，例如閃電、靜電等等，都可能導致不能正常運行。在這種情況下，請先關閉電視機的電源，或拔出交流電源線並等待 1 到 2 分鐘之後再重新插入，然後再操作電視機。
<ul style="list-style-type: none">遙控器不起作用。	<ul style="list-style-type: none">電池是否按極性（+、-）對齊了裝入？（請參閱第 16 頁。）電池是否已經電量耗盡？（更換新的電池。）遙控器是否已配對？（請參閱第 12 頁。）
<ul style="list-style-type: none">畫面被切斷。	<ul style="list-style-type: none">螢幕模式調校（例如影像尺寸）是否正確？（請參閱第 20 頁。）
<ul style="list-style-type: none">奇怪的顏色、色彩淺淡、色調昏暗、或色彩不能對準。	<ul style="list-style-type: none">調校影像色調。（請參閱第 20 頁。）房間是否太亮？在特別明亮的房間裏畫面可能看起來比較暗淡。檢查彩色制式的設置。（請參閱第 22 頁。）
<ul style="list-style-type: none">電源突然關閉。	<ul style="list-style-type: none">機器內部的溫度升高。 移開擋住通風口的物體，或是清潔通風口。是否設置了定時關機、無訊號自動關機？（請參閱第 19 頁和第 20 頁。）
<ul style="list-style-type: none">沒有影像。	<ul style="list-style-type: none">與其外部設備之間的連接是否正確？（請參閱第 14 頁、第 15 頁和第 27 頁。）是否選擇了正確的輸入？（請參閱第 26 頁。）影像調整是否正確？（請參閱第 20 頁。）天線是否正確地連接好了？（請參閱第 13 頁。）檢查彩色制式的設置。（請參閱第 22 頁。）
<ul style="list-style-type: none">沒有聲音。	<ul style="list-style-type: none">音量是否太低？（請參閱第 11 頁。）檢查聲音制式的設置。（請參閱第 22 頁。）
<ul style="list-style-type: none">電視機有時會發出破裂聲。	<ul style="list-style-type: none">這並非故障。由於溫度變化，機殼會有輕微的熱脹冷縮，此時可能發出聲響。這並不影響電視機的性能。
<ul style="list-style-type: none">無法選擇想要的頻道。	<ul style="list-style-type: none">切換數碼電視和模擬電視模式。（請參閱第 26 頁。）
<ul style="list-style-type: none">無法連接網絡。	<ul style="list-style-type: none">LAN 連線是否正確連接。（請參閱第 24 頁和第 25 頁。）請確認“網絡設置”的設定。

在高溫和低溫環境下使用的注意事項

- 當機器在低溫空間使用時（例如房間、辦公室），影像可能會出現拖尾或是出現少許延遲。這並不是故障，當溫度恢復正常時，本機的顯示也會恢復正常。
- 勿將本機置於很熱或很冷的地方。也不要將本機置於受到陽光直接照射或接近熱源的地方，否則可能會引致外殼變形，並導致液晶顯示屏發生故障。
儲藏溫度為 -20°C 至 $+60^{\circ}\text{C}$ 。

附錄

規格

項目		型號	LC-60UA50H	LC-70UA50H
解像度			8,294,400 像素 (3840(H) X 2160(V))	
視頻彩色制式			PAL / SECAM / NTSC 3.58 / NTSC 4.43 / PAL 60	
電視標準	電視制式	模擬	PAL:BG, DK, I SECAM:BG, DK NTSC:MN	
		數碼	DTMB	
	接收頻道	VHF/ UHF	44.25MHz-863.25MHz	
		CATV	S1-S41頻道 (包括超頻段)	
	數碼地面廣播	52.50MHz-866.00MHz		
立體聲 / 雙語	麗音 : BG, I, DK ; A2 立體聲 : BG			
電視調諧系統	模擬	自動預設 99 個頻道		
	數碼	自動預設 999 個頻道		
音頻輸出功率			5W x 2(左 / 右揚聲器)+20W(重低音揚聲器)	
揚聲器			Φ28mm x 2, (30mm x 70mm) x 2, Φ55mm x 4	
端子	側面	USB1	USB 2.0	
		USB2	USB 3.0	
		Micro SD 卡槽	Micro SD	
		HDMI 1	HDMI(HDMI輸入) (480i, 576i, 480p, 576p, 720p/50Hz, 720p/60Hz, 1080i/50Hz, 1080i/60Hz, 1080p/50Hz, 1080p/60Hz, 1080p/24Hz, 2160p/30Hz)	
		HDMI 2	HDMI(HDMI輸入) (480i, 576i, 480p, 576p, 720p/50Hz, 720p/60Hz, 1080i/50Hz, 1080i/60Hz, 1080p/50Hz, 1080p/60Hz, 1080p/24Hz, 2160p/30Hz)	
		HDMI 3	HDMI(HDMI輸入) (480i, 576i, 480p, 576p, 720p/50Hz, 720p/60Hz, 1080i/50Hz, 1080i/60Hz, 1080p/50Hz, 1080p/60Hz, 1080p/24Hz, 2160p/30Hz, 2160p/50Hz, 2160p/60Hz) (僅 HDMI3 端子支援HDR訊號)	
	後面	數碼音頻輸出	光纖數碼音頻輸出	
		色差 / 影音輸入	色差輸入 (480i, 576i, 480p, 576p, 720p/50Hz, 720p/60Hz, 1080i/50Hz, 1080i/60Hz) , 音頻輸入 ; 視頻輸入 , 音頻輸入	
		服務專用端子	僅用於服務	
		LAN (區域網絡)	網絡插座	
		天線	UHF/VHF 75 Ω DIN 型插座	
屏幕顯示的語言			英文 / 中文 (簡體) / 中文 (繁體)	
電源要求			交流 110-240 V , 50Hz	
整機消耗功率 (備用)			230W (0.5W)	245W (0.5W)
重量	不包括底座		21.0 kg	27.0 kg
	包括底座		22.0 kg	28.0 kg
操作溫度			0 °C 至 + 45 °C	
<ul style="list-style-type: none"> 作為不斷改進產品性能的方針之一，SHARP 公司保留為改進產品而改變設計與規格不需事先通知的權利。 				

附錄

輪廓圖

■ LC-60UA50H

單位：毫米

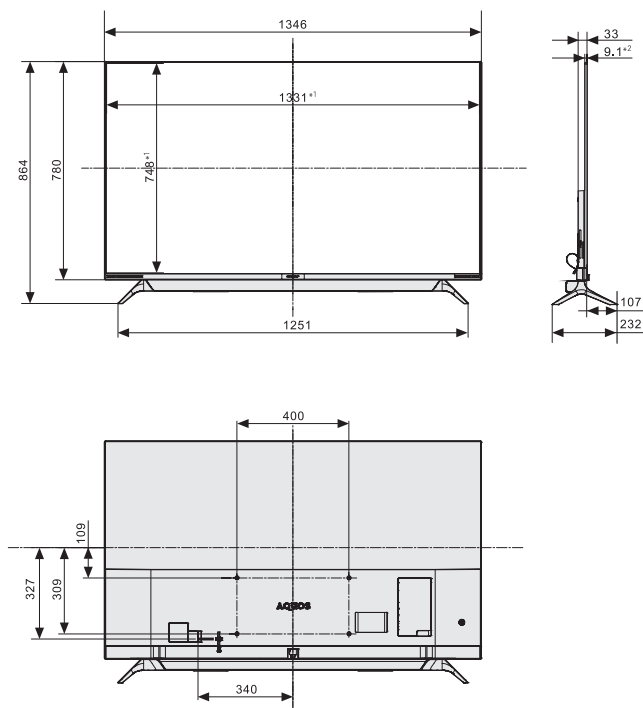

■ LC-70UA50H

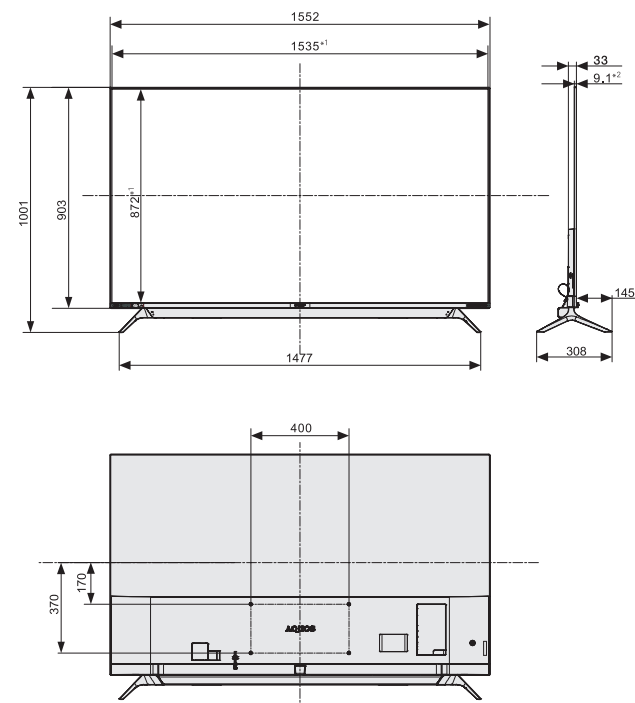

*1 有效區域
*2 最薄的部份

OPERATION MANUAL

Dear SHARP customer

Thank you for your purchase of the SHARP LCD colour TV product. To ensure safety and many years of trouble-free operation of your product, please read the Important Safety Precautions carefully before using this product.

Contents

Introduction

Dear SHARP customer	1
Contents.....	1
Precautions for daily use.....	3
Important safety precautions.....	4
Trademarks.....	5
Accessories	6

Preparation

Attaching the stand unit	7
How to make a simple platform (For LC-70UA50H only)	8
Handling and precautions with the wall-mounted TV	9
Part names.....	9
TV (Front)	9
TV (Rear)	10
Remote control unit	11
The operation button	12
Remote control pairing	12
Before turning on the power	13
Connecting external devices	14
Using digital audio output	15
Inserting a Micro SD memory card (commercially available)	15
Connecting a USB memory device.....	15
Connecting to the Network	15
Inserting the batteries	16
Cautions regarding the remote control unit.....	16
Turning the TV on/off.....	17
Running the TV for the first time	17
Turning off the TV	17
User Guide	17

Watching TV

MENU	18
MPX	18
Audio Language.....	18
Subtitle Language.....	18
Back.....	18
Info	18
EPG.....	18
Program List	18
Program Edit.....	19
Numeric Pad.....	19
HDMI Select.....	19
PC Mode.....	19
Settings.....	19
General	19
Skin setting	19
Booting state.....	19
Language	19
Default input method	19
Mouse	19
No signal power off.....	19
Sleep timer.....	20
Illumination.....	20
Starting sound.....	20

Watching TV (Continued)

Video	20
AV mode	20
Contrast/Brightness/Tint/Sharpness/Colour/Backlight/Gamma setting	20
Colour temp. (Colour temperature)	20
Wide mode.....	20
DNR.....	21
Active contrast.....	21
Fine Motion	21
Intelligent variable contrast.....	21
HDR Gamma setting.....	21
Reset.....	21
Audio	21
AV mode	21
Auto volume.....	21
Bass/Treble/Balance.....	21
Surround sound.....	21
Digital audio output.....	21
Reset.....	21
Channel	22
Auto search.....	22
Digital setting	22
Analogue setting	22
Program edit	22
Network	22
Apps	22
Option	23
Digital audio language	23
Subtitle.....	23
For hearing impaired.....	23
System	23
System info	23
Legal info	23
Local update	23
System recovery	23

Network function

Connecting to the Network	24
Wired installation	24
Wireless installation	24
Network setting	25
Ethernet network connection.....	25
Wireless network connection.....	25
Bluetooth®.....	25

Smart function

Smart home	26
TV	26
APP.....	26
Installing Apps	26
Apps	26
Text input	26
Browser	26

Other useful features

Connecting a USB memory device	27
Playing back files on a USB memory device	27
Buttons for USB media operation	28
List of file formats compatible with USB mode	29

Appendix

Troubleshooting	31
Specifications	32
Dimensional drawings	33

Precautions for daily use

Observe the following items

Maintenance of the cabinet

- When cleaning the cabinet, use a soft cloth (made of cotton, floss, etc.) to clean gently. Do not use a dry or damp rag mixed with chemicals, as this could cause the ingredients of the cabinet body to deteriorate or crack.
- Be careful not to use an abrasive cloth for cleaning or clean with excessive force, as this could scratch the surface of the cabinet.
- If the cabinet is greatly soiled, clean with a soft cloth (made of cotton, floss, etc.) soaked with a small amount of diluted neutral detergent and wrung out, and then clean with a soft dry cloth.
- Because the cabinet is made of plastic, solvents such as benzene, alcohol or thinner could cause it to deteriorate, or make its coating come off. Therefore do not use such solvents to clean the cabinet.
- Because plasticizer is included in the plastics, deterioration or the coating peeling off could occur when the cabinet comes into contact with some substances. Therefore keep it away from volatile substances such as insecticide. In addition, do not let it come into contact with objects made of rubber, resin, etc. for a long time.

Maintenance of the LCD panel

- Before cleaning the LCD panel, be sure to turn off the TV set and unplug the power cord from the outlet.
- When cleaning the LCD panel, use a dry and soft cloth (made of cotton, floss, etc.) to clean the surface of the LCD panel gently. For protecting the LCD panel, do not clean with a dirty cloth, detergent, or a dry or damp rag mixed with chemicals, as this could cause peeling of the panel surface.
- Be careful not to clean with an abrasive cloth or with excessive force, as this could cause the panel surface to be scratched.
- If the LCD panel is greatly soiled, clean it gently with a soft cloth (made of cotton, floss, etc.) soaked with a small amount of water (Do not clean with excessive force, so as to avoid the scratch of the panel surface).
- If dust sticks on the surface of the LCD panel, clean the panel with a commercially available cleaning brush (anti-static brush).

Important safety precautions

- **Cleaning** — Unplug the AC cord from the AC outlet before cleaning the product. Use a damp cloth to clean the product. Do not use alcohol cleaners, spray cleaners or chemical cloth when cleaning because these types of materials may damage the product.

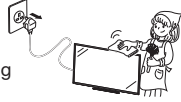

- **Water and moisture** — Do not use the product near water, such as bathtub, washbasin, kitchen sink, laundry tub, swimming pool and in a wet basement.



- Do not place vases or any other water-filled containers on this product. Do not place the product under air conditioner, humidifier and so on. The water may spill onto the product causing fire or electric shock.



- **Stand** — Do not place the product on an unstable cart, stand, tripod or table. Doing so can cause the product to fall, resulting in serious personal injuries as well as damage to the product. Use only a cart, stand, tripod, bracket or table recommended by the manufacturer or sold with the product. When mounting the product on a wall, be sure to follow the manufacturer's instructions. Use only the mounting hardware recommended by the manufacturer.



- When relocating the product placed on a cart, it must be moved with utmost care. Sudden stops, excessive force and uneven floor surface can cause the product to fall from the cart.



- **Ventilation** — The vents and other openings in the cabinet are designed for ventilation. Do not cover or block these vents and openings since insufficient ventilation can cause overheating and/or shorten the life of the product. Do not place the product on a bed, sofa, rug or other similar surface, since they can block ventilation openings. This product is not designed for built-in installation; do not place the product in an enclosed place such as a bookcase or rack, unless proper ventilation is provided or the manufacturer's instructions are followed.

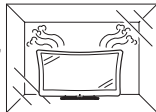

- In case the product is dropped and the cabinet is damaged, be sure to turn off the power of the product, and unplug the power cord. If you continue to use the product, it may cause fire or electric shock.



- Do not open the rear cover of the cabinet to reconstruct the circuits. There exists high voltage within the cabinet and it may cause electric shock and injury. If maintenance is required, contact your dealer.



- The LCD panel used in this product is made of glass. Therefore, it can break when the product is struck forcefully or with a sharp object. If the LCD panel is broken, be careful not to be injured by broken glass.



- **Heat sources** — Keep the product away from heat sources such as radiators, heaters, stoves and other heat-generating products (including amplifiers)



- To prevent fire never place any type of candle or naked flames on the top or near the TV set.

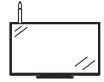

- To prevent fire or shock hazard, do not place the AC power cord under the TV set or other heavy items.

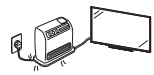

- Do not place heavy objects on this product or stand on it. Doing so could cause injury if the product overturns. Take special care near children and pets.



- Unplug the power cord before you move the TV set. If not unplugged beforehand, the power cord may become damaged and cause electric shock.

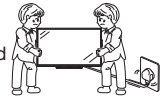

The LCD panel is a very high technology product with 8,294,400 pixels, giving you fine picture details. Due to the very large number of pixels, occasionally a few non-active pixels may appear on the screen as a fixed point of blue, green or red. This is within product specifications and does not constitute a fault.

Precautions when transporting the TV

- When transporting the TV, never carry it by holding or otherwise putting pressure onto the display. Be sure to always carry the TV by at least two people holding it with two hands — one hand on each side of the TV.



- Do not display a still picture for a long time, as this could cause an afterimage to remain.

- Install the product on the place where the AC cord can be unplugged easily from the AC outlet.

NOTE

- The above are pictures for reference only; the actual item might be different.

Trademarks

- Dolby, Dolby Audio and the double-D symbol are trademarks of Dolby Laboratories. Manufactured under license from Dolby Laboratories. Confidential unpublished works. Copyright 1992-2015 Dolby Laboratories. All rights reserved.
- The terms HDMI and HDMI High-Definition Multimedia Interface, and the HDMI Logo are trademarks or registered trademarks of HDMI Licensing Administrator, Inc. in the United States and other countries.
- **For DTS patents, see <http://patents.dts.com>. Manufactured under license from DTS, Inc. DTS, the Symbol, DTS and the Symbol together are registered trademarks or trademarks of DTS, Inc. in the United States and/or other countries © DTS, Inc. All Rights Reserved.
- The Wi-Fi CERTIFIED Logo is a certification mark of the Wi-Fi Alliance.
- SDHC logo is a trademark of SD-3C,LLC.
- MPEG Layer-3 audio coding technology licensed from Fraunhofer IIS and Thomson.
- THIS PRODUCT IS LICENSED UNDER THE AVC PATENT PORTFOLIO LICENSE FOR THE PERSONAL USE OF A CONSUMER OR OTHER USES IN WHICH IT DOES NOT RECEIVE REMUNERATION TO (i) ENCODE VIDEO IN COMPLIANCE WITH THE AVC STANDARD (“AVC VIDEO”) AND/OR (ii) DECODE AVC VIDEO THAT WAS ENCODED BY A CONSUMER ENGAGED IN A PERSONAL ACTIVITY AND/OR WAS OBTAINED FROM A VIDEO PROVIDER LICENSED TO PROVIDE AVC VIDEO. NO LICENSE IS GRANTED OR SHALL BE IMPLIED FOR ANY OTHER USE. ADDITIONAL INFORMATION MAY BE OBTAINED FROM MPEG LA, L.L.C. SEE [HTTP://WWW.MPEGLA.COM](http://WWW.MPEGLA.COM)
- THIS PRODUCT IS LICENSED UNDER THE MPEG-4 VISUAL PATENT PORTFOLIO LICENSE FOR THE PERSONAL AND NON-COMMERCIAL USE OF A CONSUMER FOR (i) ENCODING VIDEO IN COMPLIANCE WITH THE MPEG-4 VISUAL STANDARD (“MPEG-4 VIDEO”) AND/OR (ii) DECODING MPEG-4 VIDEO THAT WAS ENCODED BY A CONSUMER ENGAGED IN A PERSONAL AND NON-COMMERCIAL ACTIVITY AND/OR WAS OBTAINED FROM A VIDEO PROVIDER LICENSED BY MPEG LA TO PROVIDE MPEG-4 VIDEO. NO LICENSE IS GRANTED OR SHALL BE IMPLIED FOR ANY OTHER USE. ADDITIONAL INFORMATION INCLUDING THAT RELATING TO PROMOTIONAL, INTERNAL AND COMMERCIAL USES AND LICENSING MAY BE OBTAINED FROM MPEG LA, L.L.C. SEE [HTTP://WWW.MPEGLA.COM](http://WWW.MPEGLA.COM)
- The Bluetooth® word mark and logos are registered trademarks owned by Bluetooth SIG, Inc. and any use of such marks by SHARP Corporation is under license. Other trademarks and trade names are those of their respective owners.







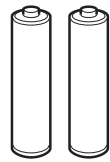

DISCLAIMERS

- This SHARP device facilitates the access to content and services provided by third parties. The content and services accessible via this device belong to and may be proprietary to third parties. Therefore, any use of such third party content and services must be in accordance with any authorization or terms of use provided by such content or service provider. SHARP shall not be liable to you or any third party for your failure to abide by such authorization or terms of use. Unless otherwise specifically authorized by the applicable content or service provider, all third party content and services provided are for personal and non-commercial use; you may not modify, copy, distribute, transmit, display, perform, reproduce, upload, publish, license, create derivative works from, transfer or sell in any manner or medium any content or services available via this device.
 - SHARP is not responsible, nor liable, for customer service-related issues related to the third party content or services. Any questions, comments or service-related inquiries relating to the third party content or service should be made directly to the applicable content or service provider.
 - You may not be able to access content or services from the device for a variety of reasons which may be unrelated to the device itself, including, but not limited to, power failure, other Internet connection, or failure to configure your device properly. SHARP, its directors, officers, employees, agents, contractors and affiliates shall not be liable to you or any third party with respect to such failures or maintenance outages, regardless of cause or whether or not it could have been avoided.
 - All third party content or services accessible via this device is provided to you on an “as-is” and “as available” basis and SHARP and its affiliates make no warranty or representation of any kind to you, either express or implied, including, without limitation, any warranties of merchantability, non-infringement, fitness for a particular purpose or any warranties of suitability, availability, accuracy, completeness, security, title, usefulness, lack of negligence or error-free or uninterrupted operation or use of the content or services provided to you or that the content or services will meet your requirements or expectations.
 - SHARP is not an agent of and assumes no responsibility for the acts or omissions of third party content or service providers, nor any aspect of the content or service related to such third party providers.
 - In no event will SHARP and/or its affiliates be liable to you or any third party for any direct, indirect, special, incidental, punitive, consequential or other damages, whether the theory of liability is based on contract, tort, negligence, breach of warranty, strict liability or otherwise and whether or not SHARP and/or its affiliates have been advised of the possibility of such damages.
- The operation manual has been collated and checked strictly. Due to factors such as software upgrading, SHARP can not guarantee that the actual operation keeps pace with the manual description.

Accessories

Supplied accessories

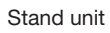
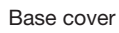
Make sure the following accessories are provided with the product.

Remote control unit	
 <p>Used with batteries inserted. Page 11</p>	
“AA” size battery (x 2)	Operation manual
 <p>Page 16</p>	
Stand unit	
 <p>“L” Stand unit</p>	 <p>“R” Stand unit</p>
 <p>“L” Base cover</p>	 <p>“R” Base cover</p>
 <p>Stand unit</p>	 <p>Base cover</p>
 <p>Long Screws (x4)</p>	 <p>Short Screws (x2)</p>
Page 7	

Preparation

Attaching the stand unit

- When you attach the stand unit, put the TV on a flat surface.
- Before attaching (or detaching) the stand unit, unplug the AC power cord from the AC power outlet.
- Before performing work, spread cushioning over the surface on which you will be laying the TV. This will prevent it from being damaged.

CAUTION

- **Attach the stand unit in the correct direction.**
- **Be sure to follow the instructions. Incorrect installation of the stand unit may result in the TV falling over.**

- 1** Place the TV on a flat surface with soft cushion on top of it. Then remove the adhesive tape on both sides, and remove the cover plate on both sides of the loudspeaker box.

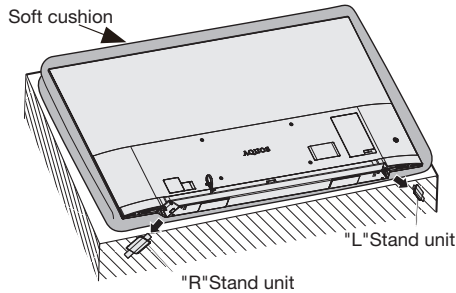

- 4** Press the base plate (small) on both sides of the stereo sound into the left and right empty groove of the sound, and make sure the cover plate is pressed tightly.

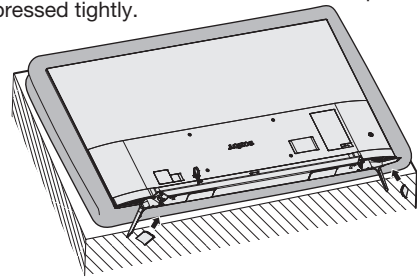

- 2** Insert the left and right base brackets into the groove at the bottom of the TV set, then move horizontally to the middle of the TV set. Please ensure that the base is jammed.

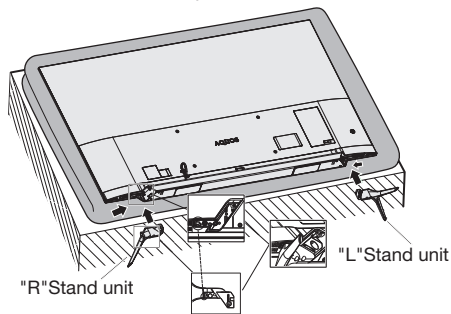

Special instructions: if you use the wall mount, please proceed with step 1, remove the cover board, then tear off the double adhesive paper on the cover board, then press the cover board on both sides of the sound, then install the wall hanging.

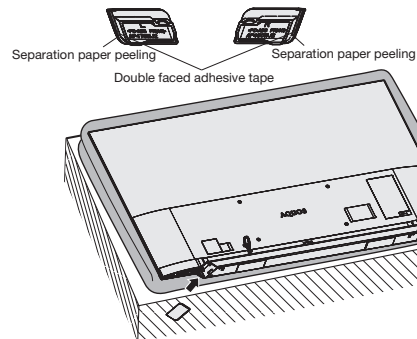

- 3** Insert the six screws into the six holes on the bottom of the stand, and tighten them.

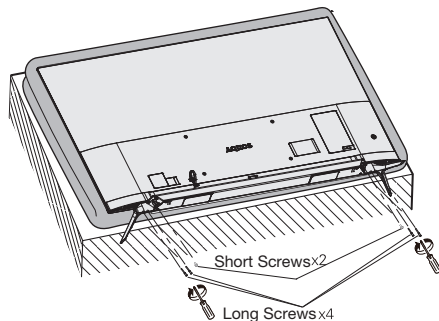

NOTE

- When installing the stand unit, you need to put your TV on a flat surface. Before that, put a soft cushion on the surface.
- To detach the stand unit, perform the steps in reverse order.
- The angle of the stand unit is not adjustable.
- A screwdriver is not supplied with this product.
- During installation, please be careful to avoid getting your hand trapped between the TV bottom and the floor.

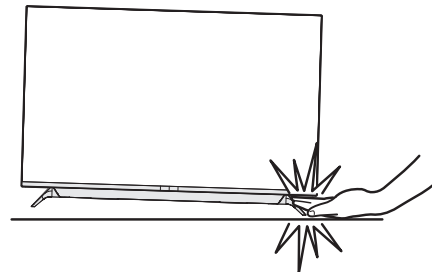

Preparation

How to make a simple platform (For LC-70UA50H only)

To make such a simple platform, you need to use the packing box and the four foam blocks inside it: TOP-L, TOP-C and TOP-R.

- 1 As shown in the following figure, remove the plastic lock at the bottom of packing box.

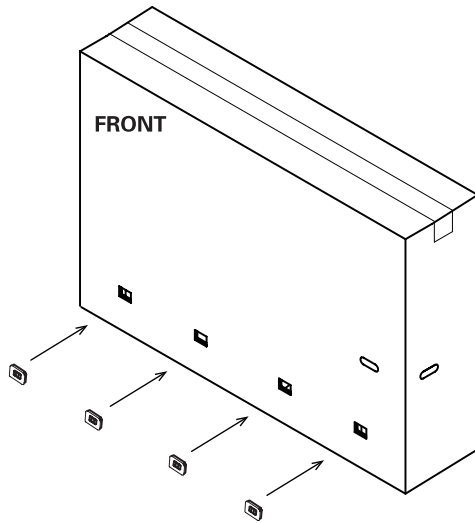

- 2 As shown in the following figure, remove the three foam blocks TOP-L, TOP-C and TOP-R on the top.

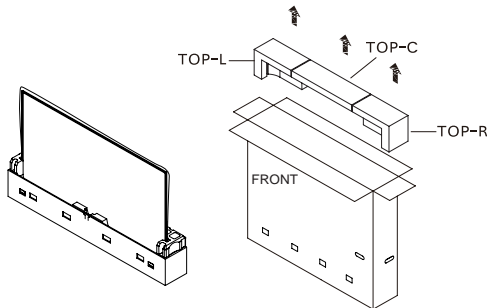

- 3
- 1 As shown in Figure A, place it face down.
- 2 Attach the foam blocks TOP-L and TOP-R onto the right side and left side of the packing box respectively (as shown in Figure B).
- 3 Insert the foam blocks TOP-C into the packing box (as shown in Figure B). Now, a simple platform is ready.

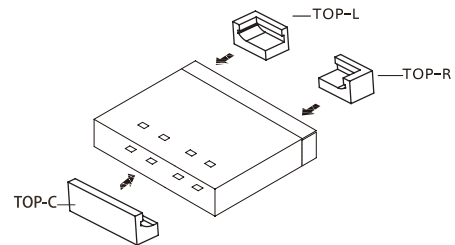

Figure A

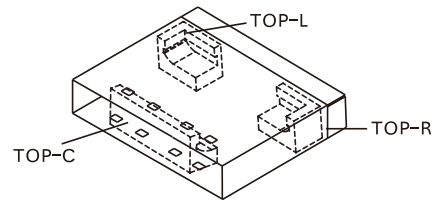

Figure B

NOTE

- Put the platform on the flat floor after you have made it.
- When installing the stand, you need to put the TV face down on the simple platform. Before that, put a shock pad on the platform to protect the screen.
- The simple platform is just for temporary use. Do not apply any load exceeding the weight of the LCD TV onto this platform.

Preparation

Handling and precautions with the wall-mounted TV

- You can mount the TV on the wall using the optional bracket.
- For details, refer to the instructions supplied with the optional bracket.

CAUTION

- **This TV should be mounted on a wall only with a wall mount bracket recommended by SHARP. The use of other wall mount brackets may result in an unstable installation and may cause serious injuries.**
- **Installing the TV requires special skills that should only be performed by qualified service personnel. Customers should not attempt to do the work themselves. SHARP bears no responsibility for improper mounting or mounting that results in accident or injury.**

Using a SHARP recommended bracket to mount the TV

- You can ask a qualified service professional about using a SHARP recommended bracket to mount the TV to the wall.
- Carefully read the instructions that come with the bracket before beginning work.

Part names

TV (Front)

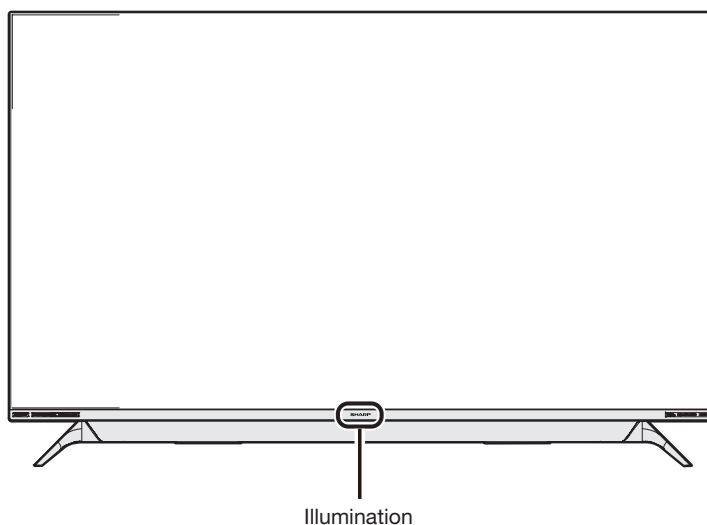

- The illustrations and on-screen displays in this operation manual are for explanation purposes and may vary slightly from the actual operations.
- The illustrations used throughout this operation manual are based on LC-60UA50H.

Preparation

TV (Rear)

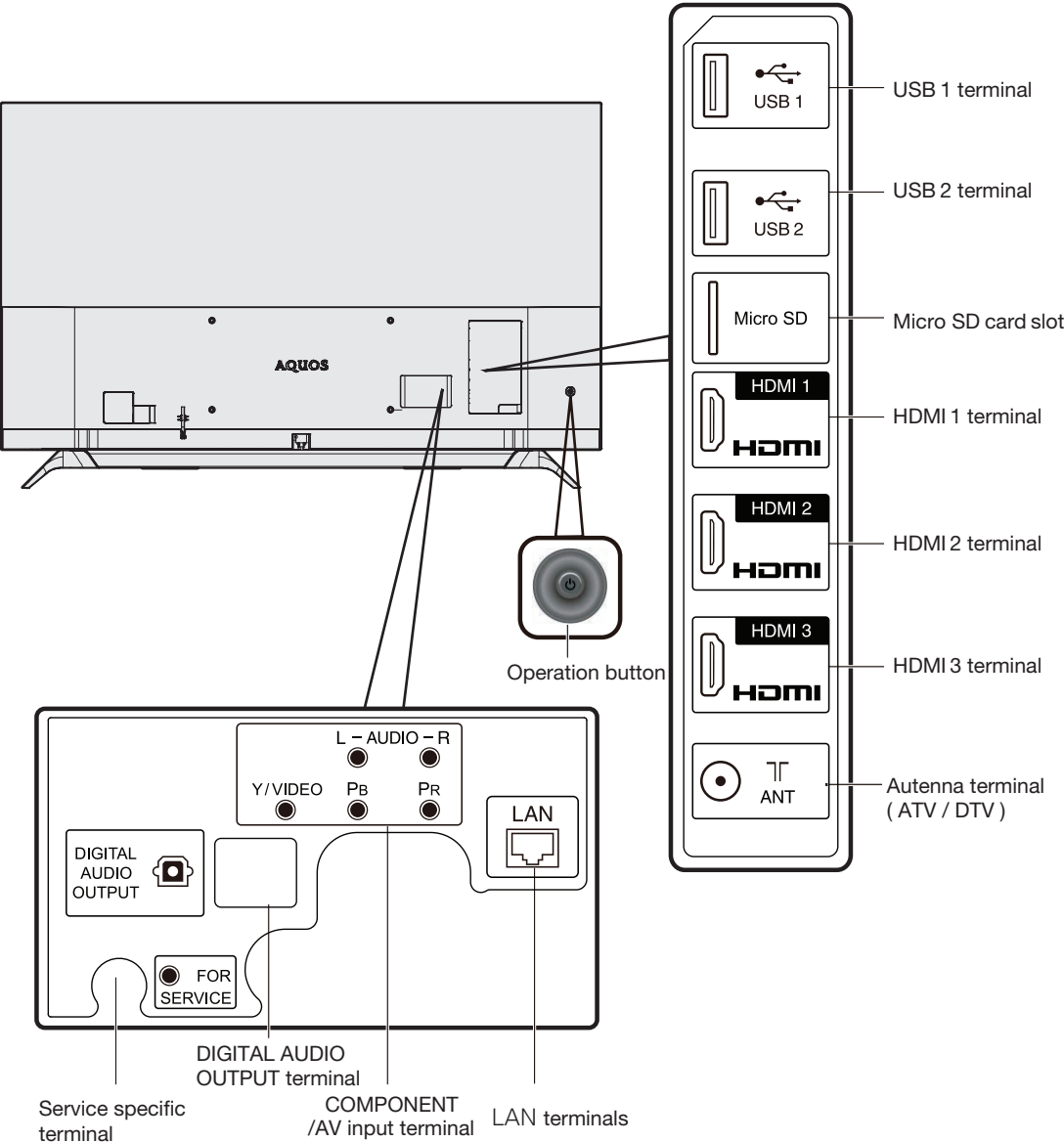

Preparation

Remote control unit

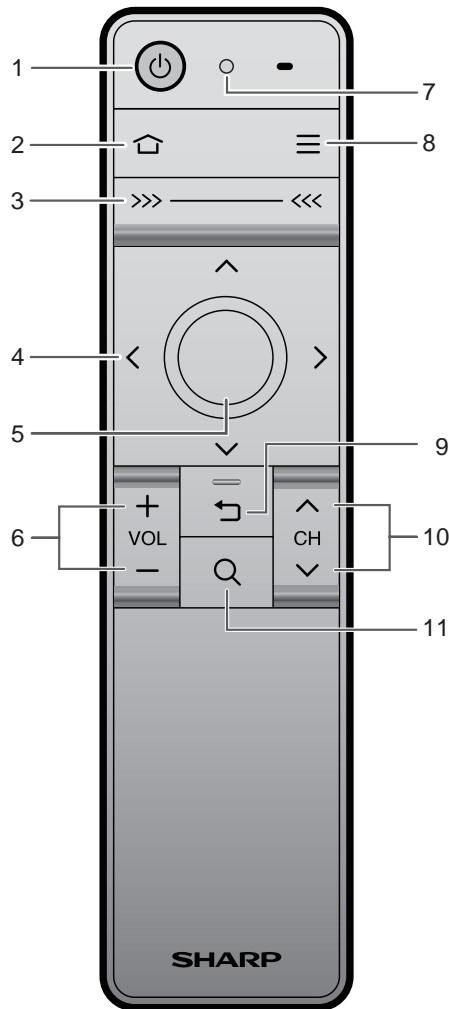

- 1 **⏻ (POWER (Standby/On))**
To switch the power on and off. (See page 17.)
- 2 **🏠 (HOME)**
Display the smart home.
- 3 **SLIDE BAR**
Touch the slide bar to switch between TV interface and App interface.
- 4 **▲/▼/◀/▶ (Cursor)**
Select a desired item on the setting screen.
- 5 **OK**
Execute a command.
- 6 **VOL +/-**
Set the volume.
- 7 **INDICATOR**
The indicator of the remote control.
- 8 **☰ (MENU)**
Display the menu list.
- 9 **↶ (RETURN)**
Return to the previous menu screen.
- 10 **CH ▲/▼**
TV input mode: Select the channel.
- 11 **🔍 (BROWSER)**
Start browser.

NOTE

- When the remote control is in sleep mode, please press any keys (except the power key) to wake up the remote control.

The indicator of the remote control

Indicator	Performance	Instructions state	Description
Blue	Rapid flash	Remind	Start the pairing.
	For 3 seconds	Remind	Pairing is OK.
Red	Slow flash for 3 seconds	Warning	Low battery ,the remote control can still be used.
	Rapid flash for 3 seconds	Warning	Serious low-battery,the remote control cannot be used.
	For 3 seconds	Warning	Pairing timeout. Pairing is failed.
Blue,Red	Alternately flash	Remind	Remove current pairing,the new remote control can pair to the TV at this time.

Preparation

■ The mouse function of the remote control

With the built-in gyroscope sensor, setup the TV through motion sensing of the remote control .

With the mouse function, you can move the cursor of the screen to selected item and press **OK** to enter when browsing the smart home.

- When the remote control is in dormancy, flick the remote control to restart it.

The operation button

You can also setup the TV through the operation button at the TV back. (The position of the operation button, please see page 10)



Action	Description
Short press	Turn on the TV.
Left/Right	Set the volume reduction/add.
Up/Down	Set the channel up/down.
Long press	Display the menu(Pairing , Power off) when the TV is switched on.

Remote control pairing

The remote control unit has been pre-paired with the TV set in factory so you can use the remote control unit directly. If the remote control fails to operate or a new remote control unit is used, please follow the following steps to pair the remote control unit and the TV.

- 1 Press the "⏻" button on the TV for a few seconds, "Pairing" and "Power off" menu will be displayed.
- 2 Use the operation button on the TV to choose "Pairing" and then press the TV operation button.
- 3 Point the remote control unit towards the bottom left corner of TV (within 20cm), press "OK" and "⏻" at the same time until red and blue lights stop flashing alternately .
- 4 Press "OK" on the remote control unit to complete the Bluetooth pairing.

NOTE

- If the TV does not display the remote control pairing information, the "Pairing" interface will be displayed automatically. Press **OK & ⏻ (POWER)** on the remote control unit at the same time, the red and blue lights flash alternately. Once the flashing stop, press **OK** to complete the Bluetooth pairing.
- If pairing is not succeed, please try again or contact the customer service center.

Preparation

Before turning on the power

Notes on installing the TV

- Avoid direct sunlight and place the TV in a well-ventilated location.
- Place the TV in a level location.
- Do not turn on the power of the TV before connecting the AC cord.
- If there are any protective plastic sheets on the TV cabinet, please take them off before connecting.

1 Connecting the antenna cable

To enjoy a clearer picture, use an outdoor antenna. The following is a brief explanation of the types of connections that are used for coaxial cable.

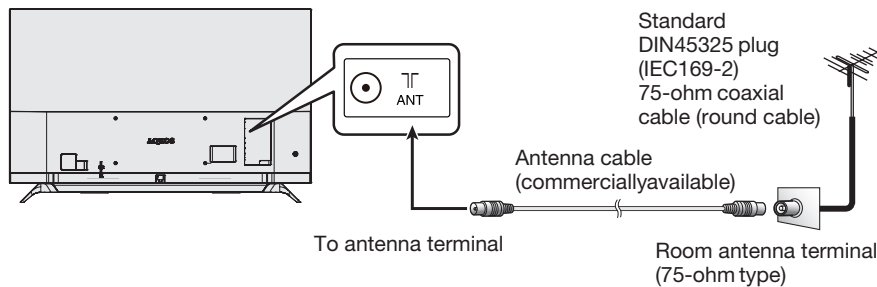

2 Connecting external devices

See page 14 and 15 for connecting external equipment, such as a VCR and DVD player.

3 Plug the AC cord into the AC outlet.

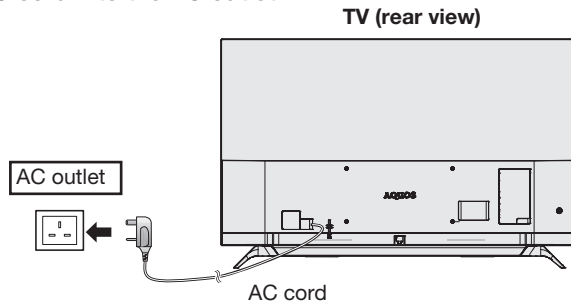

- Place the TV close to the AC outlet, and keep the power plug within reach.
- Disconnect the AC cord from the AC outlet if the TV will not be used for a long period of time.

4 Bundling the cables

As the picture illustrated, insert the cable clip into the hole on the TV, and put the cable into the cable clip for banding.

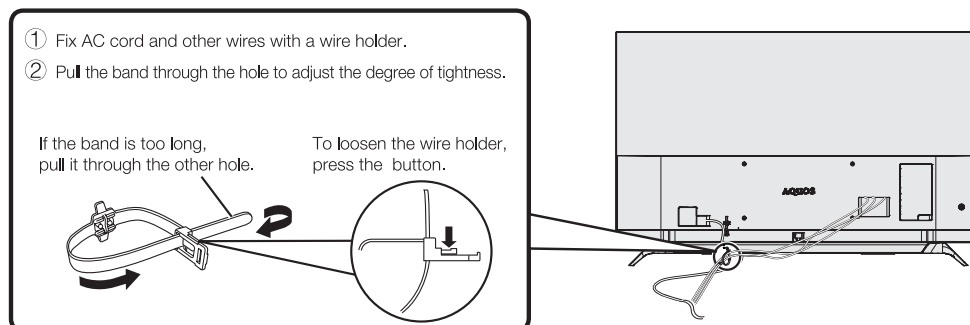

CAUTION

- To prevent risk of electric shock, do not touch un-insulated parts of any cables with the AC cord connected.

Preparation

Connecting external devices

You can connect many types of external equipment to your TV, like a VCR, Digital TV Set Top Box (STB), game console, camcorder, DVD player and PC. To view external source images, press **HOME** to the smart home interface, touch the slide bar to switch to the TV, select the input source and then press **OK**.

CAUTION

- To protect all equipment, always turn off the TV before connecting to a VCR, game console, camcorder DVD player, Digital TV Set Top Box (STB), PC or other external equipment.
- Refer to the relevant operation manual (Digital TV Set Top Box (STB), VCR, DVD player, etc.) carefully before making connections.

When using HDMI cable (commercially available)

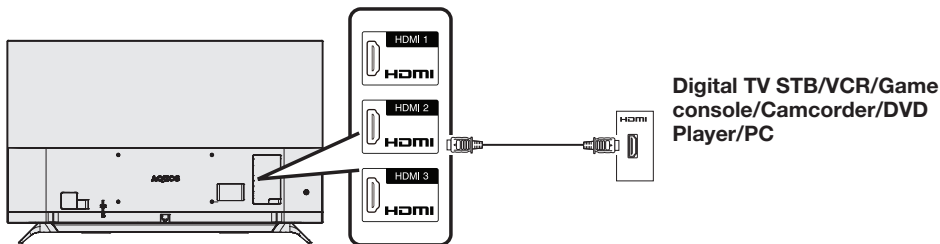

NOTE

- When using a TV set-top box to watch TV programs, use the set-top box remote control to switch channels.

When using component cable* (commercially available)

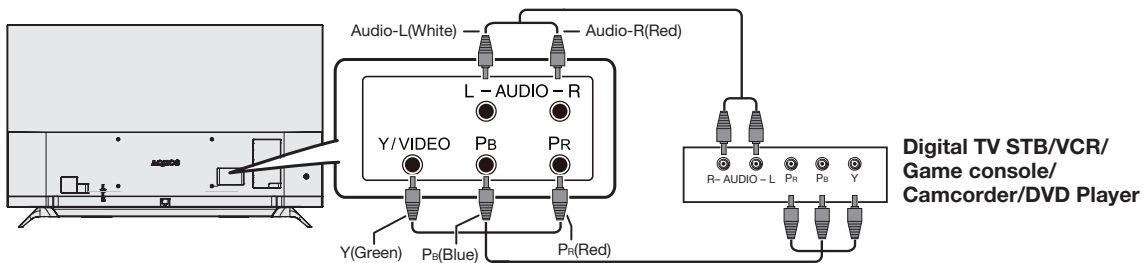

- * The component and AV input share the same terminal.

NOTE

- Insert the terminals by colour.

When using AV cable* (commercially available)

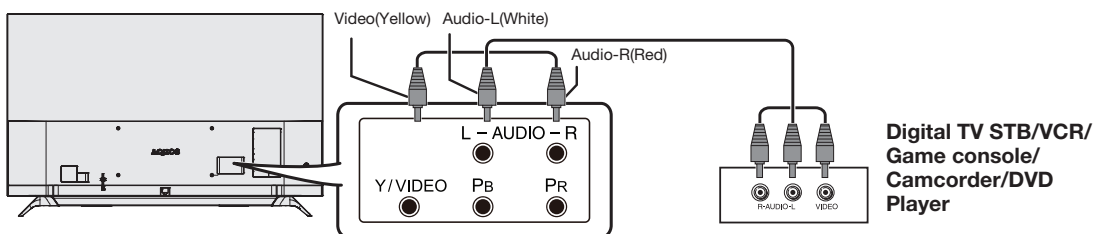

- * The component and AV input share the same terminal.

NOTE

- Insert the terminals by colour.

Preparation

Using digital audio output

It is possible to output audio through the DIGITALAUDIO OUTPUT terminal. PCM or RAW (Dolby or DTS Digital audio) outputs from the terminal.

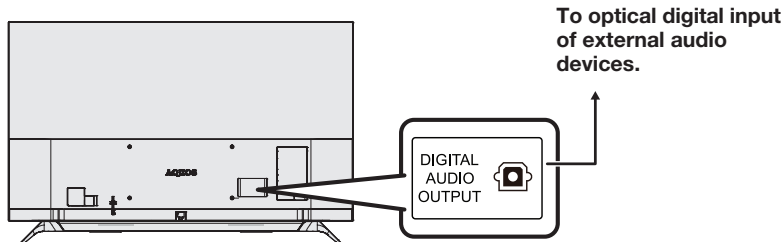

NOTE

- The DIGITAL AUDIO OUTPUT terminal usually outputs the same audio from the speakers. (The audio of the content you are viewing is output from the terminal.)
- The DIGITAL AUDIO OUTPUT terminal does not output some signals, depending on devices and software.

Inserting a Micro SD memory card (commercially available)

It provides access to Apps, video, music, and other files in Micro SD memory cards. Insert a Micro SD memory card that stores your files into the SD slot. Refer to the method of playing files stored in the USB device specified on page 27 for details.

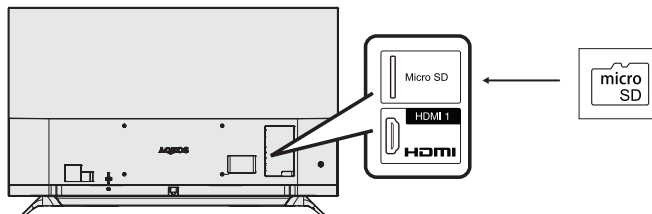

NOTE

- Insert the memory card into the slot in the direction shown in the figure.
- The Micro SD slot supports SD and SDHC type memory cards. However some memory cards may not be supported.
- This product supports memory cards with a maximum storage of 32 GB. We recommend that you use a memory card with at least a speed of Class 4 for a higher read-writespeed, thus guaranteeing the system performance.
- Unplug the memory card after you have safely unloaded it or the TV has been turned off.
- Do not unplug the memory card while data is being transferred. Otherwise the TV may malfunction.
- Regularly back up data in the memory card to prevent data corruption or operating errors of the TV. (SHARP shall not bear any responsibility for data corruption or destruction.)

Connecting a USB memory device

See page 27.

Connecting to the Network

See page 24 to 25.

Preparation

Inserting the batteries

Before using the TV for the first time, insert two “AA” size batteries (supplied). When the batteries become depleted and the remote control fails to operate, replace the batteries with new “AA” size batteries.

1 Open the battery cover.

Figure 1: Hold the front part of the remote control with one hand, pull the handle rope with another hand.

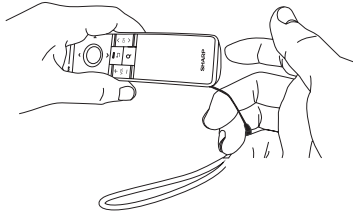

Figure 2: Place your thumb in the groove at the bottom.

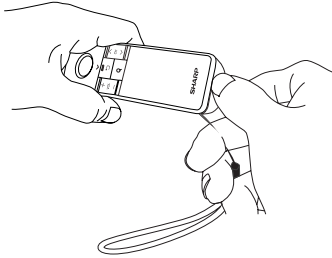
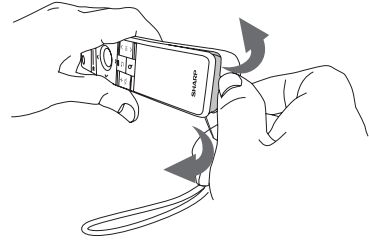
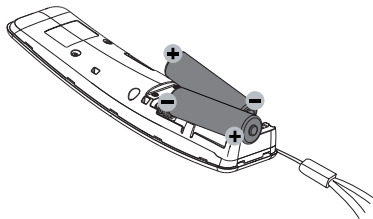

Figure 3: Pull the handle rope with your middle and index fingers and use your thumb to open the battery cover.



2 Insert the two supplied “AA” size batteries.

Place batteries with their terminals corresponding to the (+) and (-) indications in the battery compartment.



3 Close the battery cover.

Close the battery cover from top to bottom.

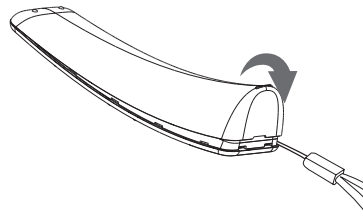

CAUTION

Improper use of batteries can result in chemical leakage or explosion. Be sure to follow the instructions below.

- Do not mix batteries of different types. Different types of batteries have different characteristics.
- Do not mix old and new batteries. Mixing old and new batteries can shorten the life of new batteries or cause chemical leakage in old batteries.
- Remove batteries as soon as they have worn out. Chemicals that leak from batteries can cause a rash. If you find any chemical leakage, wipe thoroughly with a cloth.
- The batteries supplied with this product may have a shorter life expectancy due to storage conditions.
- If you will not be using the remote control unit for an extended period of time, remove the batteries from it.
- Batteries shall not be exposed to excessive heat such as sunshine, fire or the like.

Cautions regarding the remote control unit

- Do not subject the remote control unit to shock. In addition, do not soak the remote control unit with liquids or place it in an area with high humidity.
- Do not install or place the remote control unit under direct sunlight. The heat may cause deformation of the unit.

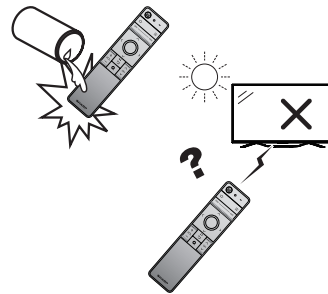

Preparation

Turning the TV on/off

Running the TV for the first time

After inserting the AC cord, the TV is in standby. Press **⏻ (POWER)** on the remote control or on the TV:

- TV is switched on.
- You can switch the TV to standby by pressing **⏻ (POWER)** on the remote control .

Turning off the TV

If the TV is switched on, press **⏻ (POWER)** on the remote control :

- TV is switched into standby and the image disappeared.
- Press **⏻ (POWER)** on the remote control to turn on the TV.
- If you want to turn off the TV from standby, please pull out the AC cord.

NOTE

- If you are not going to use this TV for a long period of time, be sure to remove the AC cord from the AC outlet.
- A small amount of electric power is still consumed even the TV is in standby mode.
- If the TV loses power in special circumstances (such as power outage or grid fluctuations, etc.), it may not work well when it is switched on again. Please try to power off the TV (by the **⏻ (POWER)** on the remote control) or unplug and replug the AC cord to restart the TV.
- It is a normal phenomenon when the TV temperature rises in the process of watching TV.
- Please do not cut off the power casually in the process of switching on or switching off the TV, running APPS or updating, otherwise TV system could not work correctly. Please turn off the TV after closing all APPS.

User Guide

When the TV powers on for the first time after purchase, the setting wizard appears. Follow the menus and make the necessary settings one after another.

Confirm the following before turning on the power

- Is the antenna cable connected?
- Is the AC cord plugged in?

Press **⏻ (POWER)** on the TV.

- It displays the boot screen, and then “Language Setting” appears.
- It may cost a little time when TV is switched on for the first time. Please wait patiently.



Language Setting

You can select the Language Setting among the “繁體中文”, “简体中文” or “EN”.

Start Settings

You can start settings according to the following steps.

Mode Setting

Please select “Home” when you watch TV at home.

- “Home”: “STANDARD” will be the default value for the “AV mode” setting.
- “Store”: “Store” is only for retail store displays. “DYNAMIC (Fixed)” will be the default value for the “AV mode” setting. If the “AV mode” is changed, the TV will automatically switch back to “DYNAMIC (Fixed)” when there is no further change to TV setting for 10 minutes.

TV Channels Setting

The TV will sort and store all the receivable TV channel according to their settings and the connected antenna.

Network Setting

You can select “Ethernet” or “Wi-Fi” to connect the network.

Please see page 24 to 25.

Watching TV

When the initial setup has completed, you can enter to smart home.

Press the ◀/▶, or touch the **SLIDE BAR** to switch the page of the smart home. Move to ATV, DTV or the input sources, and then press **OK**. Move to the programme and press **OK** to play the program in full-screen.

MENU

MPX

You can switch between multiple audio modes when watching a multiple audio or stereo broadcast programme.

In the NICAM TV broadcasts

Signal	Mode switch
When receiving a stereo signal	NICAM STEREO, MONO
When receiving a bilingual signal	NICAM DUAL I, NICAM DUAL II, NICAM DUAL I + II, MONO.
When receiving a monaural signal	NICAM MONO, MONO

In the TV mode of A2 TV broadcasts

Signal	Mode switch
When receiving a stereo signal	STEREO, MONO
When receiving a bilingual signal	CH A, CH B, CH AB
When receiving a monaural signal	MONO

- 1 Press **≡ (MENU)** to display the menu screen in full-screen TV programs.
- 2 Press **▲/▼** to select "MPX" and then press **OK**.
- 3 Press **◀/▶**, press **OK** to select the desired audio language.

NOTE

- Select the audio language for ATV only.

Audio Language

Setup preferred audio language for DTV only.

- 1 Press **≡ (MENU)** to display the menu screen in full-screen TV programs.
- 2 Press **▲/▼** to select "Audio Language" and then press **OK**.
- 3 Press **▲/▼** to select the desired audio language, and then press **OK**.

Subtitle Language

Setup preferred subtitle language if the subtitle languages are available.

- 1 Press **≡ (MENU)** to display the menu screen in full-screen TV programs.

- 2 Press **▲/▼** to select "Subtitle Language" and then press **OK**.

- 3 Press **▲/▼** to select the desired subtitle language, and then press **OK**.

Back

You can switch the current tuned channel or external input source to the previous tuned channel or external input source.

- 1 Press **≡ (MENU)** to display the menu screen in full-screen TV programs.
- 2 Press **▲/▼** to select "Back" and then press **OK**.
- 3 According to the above steps 1 and 2, you can return to the current tuned channel or external input source.

Info

Display the information of the programs, only for DTV.

- 1 Press **≡ (MENU)** to display the menu screen in full-screen TV programs.
- 2 Press **▲/▼** to select "Info" and then press **OK**.

EPG

The EPG (Electronic Programme Guide) is broadcasted together with DTV. The TV screen shows the EPG when you select it, provided that the TV is receiving the digital broadcasting signal. The EPG enables you to check the schedule of DTV and view detailed information.

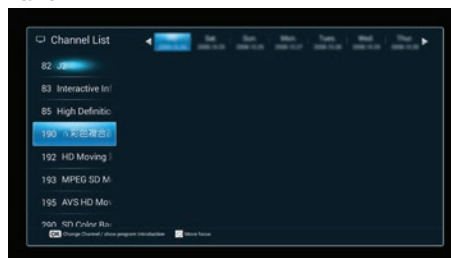

- 1 Press **≡ (MENU)** to display the menu screen in full-screen TV programs.
- 2 Press **▲/▼** to select "EPG" and then press **OK** to display programme information.

NOTE

- The time displayed on the EPG is information sent by the TV station.

Program List

Display the channel list.

- 1 Press **≡ (MENU)** to display the menu screen in full-screen TV programs.
- 2 Press **▲/▼** to select "Program list", and then press **OK**.
- 3 Press **▲/▼** to select the desired channel, and then press **OK** to switch to the selected channel.

Watching TV

Program Edit

Use this menu to set up a channel individually.

- 1 Press **MENU** to display the menu screen in full-screen TV programs.
- 2 Press **▲/▼** to select "Program Edit", and then press **OK** to display the channel list.
- 3 Press **▲/▼** to select the desired channel.

Label

You can change individual channel names.

- 1 Press **◀/▶** to select "Label", and press **OK**.
- 2 Press **▲/▼/◀/▶/OK** to select a character, and then press **↵ (RETURN)** to save and exit.

NOTE

- Maximum 8 alphanumeric characters can be input.
- Labeling is only available for the ATV mode.

Sort

Channel positions can be sorted freely.

- 1 Press **◀/▶** to select "Sort", and press **OK**.
- 2 Press **▲/▼** to move it to the desired position, and then press **OK**.
- 3 Repeat the above operation until the completion of all of the channels.

Skip

Channels which have been set to "Skip" are passed over, even if using **CH ▲/▼** to select them.

- 1 Press **◀/▶** to select "Skip", and press **OK**. The channel has been skipped.
- 2 You can select "Skip" and press **OK** again to cancel the skip.

Delete

Channels can be erased individually.

Press **◀/▶** to select "Delete". Press **OK** to select "Yes", and then press **OK** to erase the selected channel.

Numeric Pad

Press **▲/▼/◀/▶/OK** to input the number, it will switch to the selected channel.

HDMI Select

When you connect external device to output 4K (60Hz) signal, please use the HDMI3 terminal and select "4K (60Hz)".

- 1 Press **MENU** to display the menu screen with full-screen HDMI3 TV signals.
- 2 Press **▲/▼** to select "HDMI Select" to "4K(60Hz)", and then press **OK**.

PC Mode

Select only when inputting a signal from HDMI terminal. It's suitable for computer to display the text content.

NOTE

- PC mode is only suitable for PC input.

Settings

According to your needs to set the options table.

General

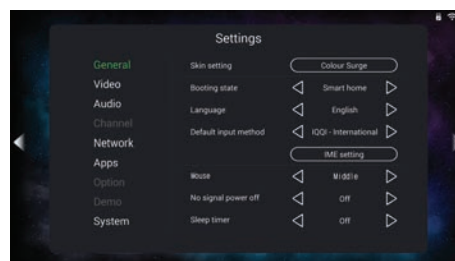

Skin setting

You can change the skin of smart home.

Select from "Colour Surge" or "Minty Fresh".

Booting state

You can set booting state between "TV" and "Smart home".

NOTE

- "TV": When turn on the TV, it displays TV mode.
- "Smart home": When turn on the TV, it displays the smart home.

Language

You can select a language from the menu.

Select from among 3 languages: English, 繁體中文 or 簡體中文.

Default input method

For setting input method.

NOTE

- The initial installation of the TV is "IQQI-International".
- If you use any other input method, SHARP cannot guarantee its compatibility with television system.

Mouse

Set up the sensitivity of the mouse function. You can select from "High", "Middle" or "Low".

No signal power off

You can set the TV to automatically power off in about 15 minutes after the TV goes into a state of receiving no programme signals.

Five minutes before the power shuts down, the remaining time displays every minute.

Watching TV

Sleep timer

Auto power-off at a designated time. You can choose from "Off", "30min.", "60min.", "90min.", "120min." or "150min."

NOTE

- When the time has been set, countdown automatically starts.
- Five minutes before the preset of time expires, the remaining time displays each minute.

Illumination

You can change the illumination setting. Select from "On" or "Off".

Starting sound

You can change the starting sound setting. Select from "On" or "Off".

Video

Set the video as you desired.

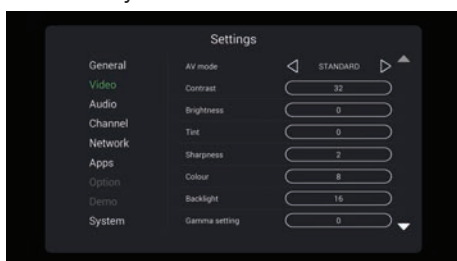

AV mode

The "AV mode" function enables you to select appropriate settings for audio and video to account for the system environment.

Selected item	Description
STANDARD	For a highly defined image in a normally bright room.
MOVIE	For viewing the movies.
GAME	Lowers image brightness for easier viewing.
USER	Allows the user to customise settings as desired. You can set the mode for each input source.
DYNAMIC	For a clear-cut image emphasising high contrast for sports viewing.
DYNAMIC (Fixed)	Changes the image and sound settings to the factory preset values. No adjustments are allowed.

NOTE

- You can select a different "AV mode" item for each input mode.

Contrast/Brightness/Tint/Sharpness/Colour/Backlight/Gamma setting

You can adjust the picture to your preference.

Selected item	◀ button	▶ button
Contrast	For less contrast.	For more contrast.
Brightness	For less brightness.	For more brightness.
Tint	Skin tones become reddish.	Skin tones become greenish.
Sharpness	For less sharpness.	For more sharpness.
Colour	For less colour intensity.	For more colour intensity.
Backlight	The screen dims.	The screen brightens.
Gamma setting	For less middle brightness.	For more middle brightness.

Colour temp (Colour temperature)

Adjusts the colour temperature to give the best white image. You can select "High", "M-high", "Middle", "M-low", or "Low".

Wide mode

You can select different picture sizes that account for the kind of each picture.

Selected item	Description
Normal	For 4:3 standard pictures. A side bar appears on each side.
Zoom 14:9	For 14:9 letterbox pictures. A thin side bar appears on each side, and you may also see bars on the top and bottom with some programmes.
Panorama	In this mode the picture is progressively stretched toward each side of the screen.
Full	For 16:9 squeeze pictures.
Cinema 16:9	For 16:9 letterbox pictures. Bars may appear on the top and bottom with some programmes.
Cinema 14:9	For 14:9 letterbox pictures. Bars may appear on the top and bottom with some programmes.
Dot by Dot	Display an image with the same number of pixels on the screen (only when receiving 2160p signal).
Underscan	Display with an underscan image only when receiving a 720p / 1080i / 1080p signal. Display with the High-Definition image adjusted optimally. Noise may appear on the edge of the screen with some programmes.

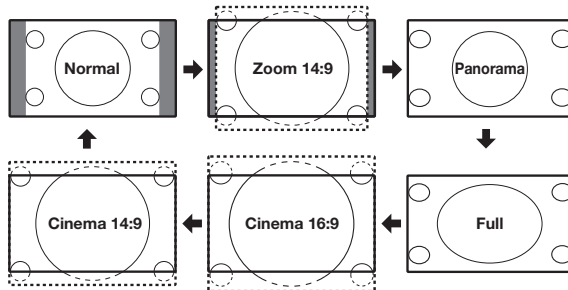

NOTE

- Some picture sizes may not be displayable depending on the input signal.
- "Zoom 14:9" and "Cinema 14:9" are only available for the DTV or ATV mode.

Watching TV

DNR

Reduce noise on screen and produces a clearer video. You can select "Auto", "High", "Low", or "Off".

Active contrast

Automatically adjust the contrast of an image according to the scene.

Fine Motion

Using the fine motion function can view the high speed motion image more clearly. You can select "Advanced", "Standard", or "Off".

NOTE

- Only applicable for 24/30Hz input signal.

Intelligent variable contrast

The function divides the backlight into different segments according to picture brightness. It constantly analyzes and adjusts the brightness of the input signal to optimize the picture brightness which brings brilliant and colourful image. You can select "High", "M-high", "Middle", "Low" or "Off".

Selected item	Description
High M-High Middle Low	It displays brightness with 4 levels (High, M-High, Middle, Low) through fine image control and backlight control.
Off	No adjustment.

HDR Gamma setting

You can adjust the HDR image signal input. The value is bigger, pay attention to the brightness. The value is smaller, pay attention to the contrast.

Reset

Reset all picture adjustment items to the factory preset.

Audio

Set the audio as you desired.

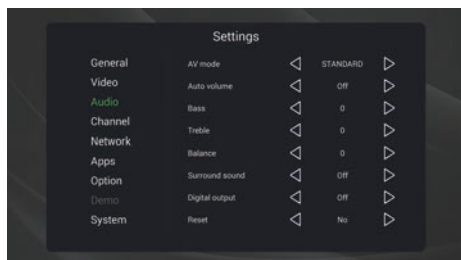

AV mode

Please see page 20.

Auto volume

Different sound sources sometimes do not have the same volume level, such as a programme and its commercial breaks. The automatic volume control (Auto volume) reduces this problem by equalizing levels.

Bass/Treble/Balance

You can adjust the audio of the selected AV mode.

Selected item	◀ button	▶ button
Treble	For weaker treble	For stronger treble
Bass	For weaker bass	For stronger bass
Balance	Decrease audio from the right speaker	Decrease audio from the left speaker

NOTE

- They cannot be changed during "DYNAMIC(Fixed)" mode.

Surround sound

The surround sound function produces a surround effect from the speakers.

Digital audio output

This function allows you to select your favourite audio output system.

Item	Description
PCM16	The optical output format is normally in PCM.
RAW	Dolby Digital or DTS is output when the Dolby Digital or DTS audio formats are received.

NOTE

- Analog channel audio and video input audio are output in PCM mode even when "RAW" is selected.
- PCM digital input signals are output in PCM mode even when "RAW" is selected.

Reset

Reset all audio adjustment items to the factory preset values.

Watching TV

Channel

Set the channel as you desired .

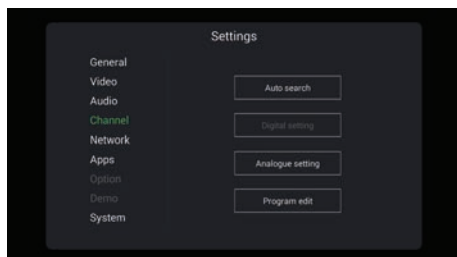

Auto search

You can run auto installation again, even after setting up the preset channels.

NOTE

- Auto search can only search channels from the current mode.

Digital setting

You can set some DTV channel items manually.

Auto search

Use this menu to add new DTV services automatically after auto installation has been completed.

Manual search

Add new services within a specified frequency band.

Signal info

Show the “ChannelNo.”, “Freq”, “Signalstrength” and “Signalquality” of the current program.

NOTE

- The values of “Signalstrength” and “Signalquality” indicate when to check the appropriate alignment of the antenna.

Analogue setting

You can set some ATV channel items manually.

Auto search

Use this menu to add new ATV services automatically after auto installation has been completed.

Manual search

You can set the channel manually.

Item	Description
Storage to [1~99]	Save programme to your desired channel number. Press OK to save.
Current CH	Select the channel you want to edit.
Colour system	Select the optimum colour system to receive. (PAL, SECAM, NTSC)
Sound system	Select the optimum sound system (Broadcastingsystem) to receive. (BG, DK, I, MN)
Search	Start searching from current channel. You can search the next channel by pressing ◀/▶ to adjust the frequency .
Fine-Tune	Tune the frequency of the stored channel to your desired position.

Program edit

Please see page 19.

Network

Please see pages 24 to 25.

Apps

Please see page 26.

Watching TV

Option

For setting other items.

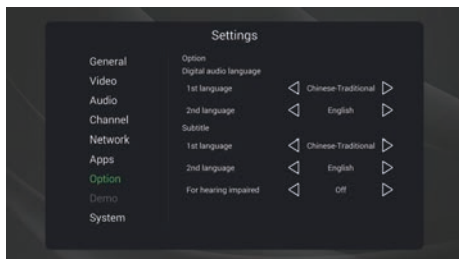

Digital audio language

Set up to preferred multi audio languages to display if the audio languages are available.

NOTE

- This function depends on audio language information from broadcasters.
- If audio for the selected language is not included in a received broadcast, audio will not be output for that language.

Subtitle

Setup preferred subtitle language if the subtitle languages are available.

NOTE

- If subtitles for the selected language are not included in a received broadcast, subtitles will not be shown for that language.

For hearing impaired

If the broadcast includes subtitles for the hearing impaired, they will take precedence over other subtitles.

NOTE

- If the broadcast includes no subtitles for the hearing impaired, they will not be displayed even when set to "On".
- Select option for DTV only.

System

You can view and set the info about the system.

System info

From here, you can view the Hardware info and Software info.

Legal info

From here, you can view the open source licenses.

Local update

This function allows you to transform to the latest software via a USB device.

NOTE

- If the software is not compatible with the system, an error message appears on the screen. Please enter Settings → System → local update to operate.
- When an error message displays, check to see if
 - The USB device is inserted firmly.
 - The USB memory has two or more software files.
 - No software for updating the system exists in the USB memory.
 - The software file is broken.
 - The software file is not compatible with your TV's software.
- Please do not turn off TV or execute other operations during version up.

System recovery

If complex adjustments are made and the settings cannot be restored to normal, you can reset the settings to the factory preset values.

Network function

Connecting to the Network

To enjoy internet services, you need to connect the TV to a router with a high speed connection to the internet.

NOTE

- If you do not have a broadband internet connection, consult the store where you purchased your TV or ask your internet service provider or telephone company.
- A stable connection speed is required to play back streaming content, otherwise you may not be able to watch normally.

Wired installation

Switch on the router (commercially available). Refer to the router's operation manual for switching on. Connect the LAN terminal on the TV to the router (commercially available) with a LAN cable (commercially available).

Wired connection overview

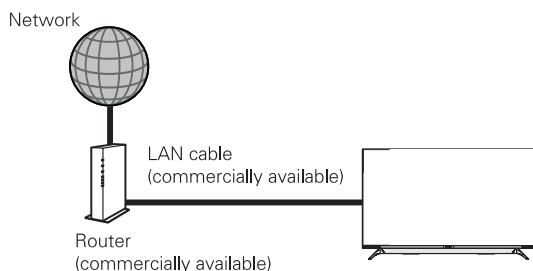

How to connect

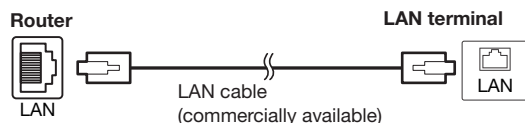

Wireless installation

Switch on the router (commercially available). Refer to the router's operation manual for switching on.

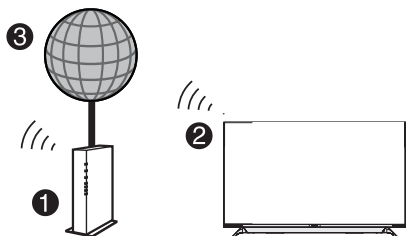

- 1 Wireless LAN router/access point
- 2 TV
- 3 Network

NOTE

- This TV has received the following certifications.
 - Wi-Fi CERTIFIED™ (certifications program from the Wi-Fi Alliance®)
- A wireless LAN connection and performance cannot be guaranteed for all residential environments. In the following cases, the wireless LAN signal may be poor or drop, or the connection speed may become slower.
 - When used in buildings made with concrete, reinforced steel, or metal.
 - When placed near objects that obstruct the signal.
 - When used with other wireless devices that emit the same frequency.
 - When used in the vicinity of microwave ovens and other devices that emit a magnetic field, electrostatic charge, or electromagnetic interference.
- Make sure the firewalls in your network allows access to the TV wireless connection.
- Operations cannot be guaranteed when used with access points that do not have Wi-Fi® certification.
- A wireless LAN access point is required to connect the TV to the Internet using a wireless LAN. See the operation manual of your access point for setup.
- A stable connection speed is required to play back streaming content. Use a wired connection if the wireless LAN speed is unstable.
- As there are lots of formats in the internet, some formats may not be supported by this TV unit.
- Before transferring to a third-party or disposal, be sure to initialise the wireless LAN settings.

Network function

Network setting

Select "Setting" in the menu, and then press **OK**. Press **▲/▼** to select "Network", and then press **OK**. It displays the connect format.

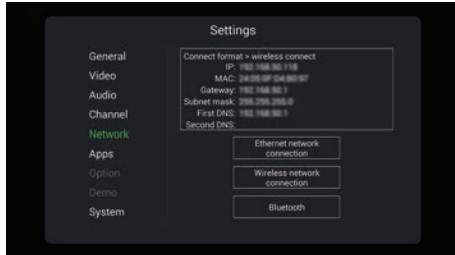

Ethernet network connection

You can select "Ethernet" to connect the network.

■ DHCP

System will attempt to obtain IP address and other information automatically.

■ Manual connection

You can setup IP address, Gateway, Subnet mask, First DNS and Second DNS following the on-screen instructions.

Wireless network connection

You can select "Wi-Fi" to connect the network.

When adjust "Wi-Fi" to "On", it displays the nearby wireless network.

If the current network connection security is not open, you should enter the password from software keyboard by pressing **OK** on the remote control.

NOTE

- You can press **MENU** to select "Network" to switch the connection between Ethernet network connection and Wireless network connection.

■ Add network

You can add unbroadcast wireless network manually.

Enter the information about the unbroadcast wireless network, and then select "Save". Now the TV is connected to the unbroadcasted wireless network.

Bluetooth®

Select the "Bluetooth" and then press **OK**, the TV is scanning Bluetooth devices.

If you want to connect to the Bluetooth device, please refer to the screen reminder.

NOTE

- The Bluetooth device may not operate properly depending on the device being used.

Smart function

You can download and install amounts of Apps from the third-party of the smart TV. Press **HOME** to display the smart home.

Smart home

Smart home will provide TV and APP screens. It's convenient for you to operate with intuitive interface. You can slide screens between TV and APP, and press **OK** into specific content.

TV

Select an input source (ATV, DTV, HDMI1, HDMI2, HDMI3, COMPONENT, AV), and then press **OK** on the remote control.

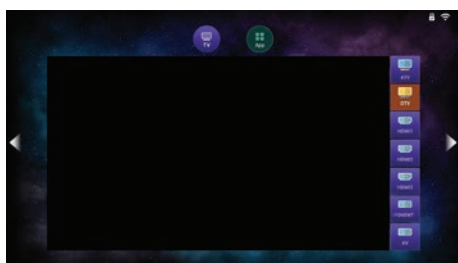

APP

Provide you mass Apps.

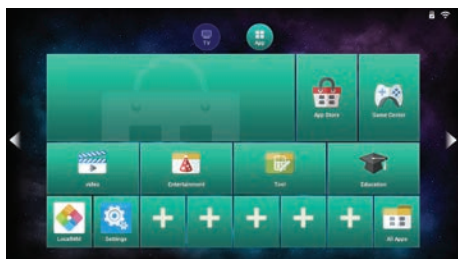

In APP screen, you can experience the supplied applications provided with the TV, also you can download more apps from the app store.

Installing Apps

From "App Store", select the App you desired, and install it according to prompt in the screen.

Apps

You could manage all Apps that have been downloaded into TV.

- 1 Select "Settings" and press **OK** in the APP screen.
- 2 Press **▲/▼** to select "Apps", and then press **OK**. Press **▲/▼** to select the items you want, and then press **OK**.

Internal storage

From here, you can view the free space and the total storage space of TV.

SD card storage

From here, you can view free space and the total storage space of SD card.

Install applications from unknown sources

From here, you can setup whether applications are allowed to install from unknown sources.

Default installation location

From here, you can setup the default installation location. Select from among 3 locations: Default, Internal, External.

My Apps

It will display applications list that have been installed. Operations such as "Force stop", "Uninstall", "Clear cache" or "Move to SD card/Move to internal" can be used to an application.

NOTE

- When using the child mode app, if you forget password, please enter the password "3001" to reset.

Format Micro SD card

To format Micro SD card.

NOTE

- If you format Micro SD card, the content stored in the Micro SD card will be deleted completely and the content is unrecoverable. Please operate it carefully.

Safely Remove Micro SD card

Remove Micro SD card after you have safely unloaded it.

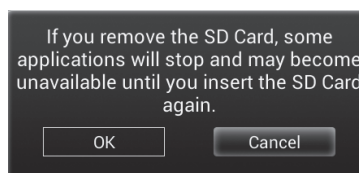

NOTE

- Do not unplug the memory card while data is being transferred. Otherwise the TV may malfunction.
- Unplug the memory card after you have safely unloaded it or the TV has been turned off.
- Please regularly back up data in the memory card to prevent data corruption or operating errors of the TV. (SHARP shall not bear any responsibility for data corruption or destruction.)

Text input

The virtual keyboard appears when you press **OK** to input text.

It provides virtual keyboard input mode. In the process, you can choose character by moving cursor, and press **OK** to complete character input. At the same time, you can change the input mode from virtual keyboard.

Browser

In App screen, select "Browser" and press **OK**, or press **Q(BROWSER)** on the remote control to start browsing internet.

Other useful features

You can connect a USB memory device or a USB hard disk drive (HDD) to the TV to enjoy viewing pictures, listening to the audio, and watching videos.

NOTE

- Depending on the USB memory device, the TV may not be able to recognise the data.
- It may take time to read the data if the USB memory device contains many files or folders.
- External subtitles for some video files may not be supported.

Connecting a USB memory device

Insert the USB memory device with recorded pictures audio or videos into the USB 1 or USB 2 terminal on the TV.

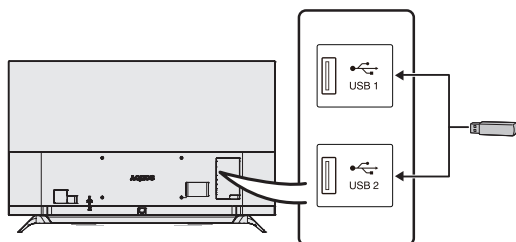

- The USB1 and USB2 terminals cannot be connected with USB hard disk drives at the same time.
- When connecting a USB hard disk drive, be sure to use a hard disk drive with an AC adapter.
- Do not remove the memory device from the TV while transferring files.
- Do not insert and remove a USB memory device/ USB hard disk drive to and from the TV repeatedly.
- When using a card reader, be sure to insert Memory card first before using the card reader.
- The TV may not be able to recognise the card reader.
- Please follow the rules below when the TV is displaying the file of the USB device:
 - Please do not turn off the TV directly.
 - Please don't disconnect the USB device directly.
 - Please be sure to exit from USB interface before removing the USB device, otherwise you may lose the data, damage the device or TV system may not work properly.
- If the TV connects with USB-HUB, the TV may not be able to recognise all USB memory devices.

CAUTION

- Do not use the USB extension cable, otherwise it may cause the TV does not work properly.
- Please insert the USB device after the TV is powered on properly.



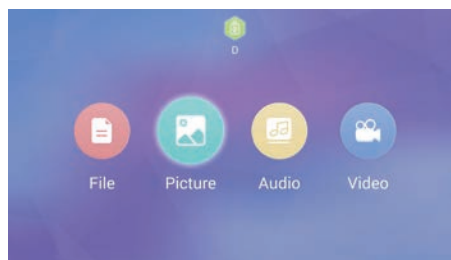





















Playing back files on a USB memory device



- 1 Press **HOME** to display the smart home, and then touch the slide bar to switch to App interface. Select "LocalMM" and then press **OK**.
- 2 Press **▲/▼/◀/▶** to select the device or disk drive you want.
- 3 Press **▲/▼/◀/▶** to select the desired folder, such as "File", "Picture", "Audio", "Video", and then press **OK**. Select the desired file, and then press **OK**.
 - Press **RETURN** on the remote control, you can exit to the upper folder.
- 4 Press **MENU** to display the USB media operation menu when you view a photo or a video. Press **▲/▼** to select the relevant functions, and then press **OK**. To know the buttons for USB media operation in detail, please see page 28.

Other useful features

Buttons for USB media operation

Button/menu	Description	Video mode	Audio mode	Picture mode
	Play/Pause.	✓	✓	-
	Go to the previous file.	-	✓	-
	Go to the next file.	-	✓	-
	Loop. Each time you press OK , the mode will switch from Order play, Repeating all songs, Play this song only once, Repeating current song and Shuffle is on.	-	✓	-
	Playlist Select a file from the playlist to start playback.	-	✓	-
 Scale	Press CH  /  to switch photo size. Press  /  to move.	-	-	✓
 Rotate	Rotate the picture Press  or  to rotate the image 90 degrees anticlockwise, and press  or  to rotate the image 90 degrees clockwise. Press  to exit this mode.	-	-	✓
 Sliding	Set the Time Interval and Animation of the slide.	-	-	✓
 TV Setting	You can set the TV.	✓	✓	✓
 Subtitle Options	Set Subtitle On-off, Subtitle Select, Subtitle Switching, Subtitle Search and Subtitle Advanced.	✓	-	-
 Audio Options	Select audio track.	✓	-	-
 Jump Time	Set the starting playback time.	✓	-	-
 Advanced Options	Set Continue Play, Forward Rewind and Single Cycle.	✓	-	-
	Press OK to the previous file.	✓	-	-
	Press OK to the next file.	✓	-	-
Fast forward	Press  to fast forward.	✓	✓	-
Reverse	Press  to reverse.	✓	✓	-
	Go to the previous file.	-	-	✓
	Go to the next file.	-	-	✓

Other useful features

List of file formats compatible with USB mode

Supported video format

File extension	Video decoder	Audio decoder	Subtitle
.avi	MPEG2 MP@HL MPEG4 SP@L0-3,ASP@L-05 MPEG4 ASP(GMC0,1p) H.264 HP@Up to Level 4.0 H.264 MP@L 4.0 H.265(HEVC) Main Profile @ Up to Level 5 (4k2k 30 fps) H.265(HEVC) Main Profile @ Up to Level 5.1 (4k2k 60 fps) MPEG4 ASP@Level5 H.264 HP@Up to Level 5.1 H.264 HP@Up to Level 4.1 H.264 (AVC) MP@L 4.1	PCM AC3 WMA,WMA Pro MP3 AAC,support MPEG2 AAC(AAC-LC) & MPEG4 AAC-LC HE-AAC,support MPEG4 HE-AAC v2 MPEG Audio,support MPEG1 Layer 1/2 Dolby Digital Plus Dolby Digital DTS	External: MicroDVD SRT SSA ASS Subview Vobsub Inside: Vobsub
.mkv	MPEG1 MP MPEG2 MP@HL MPEG-4 SP@HL 3.0 & MPEG-4 ASP@HL 4.0 H.264 HP@Up to Level 5.1 H.264 HP@Up to Level 4.1 H.265(HEVC) High/Main Profile @ Up to Level 5 (4k2k 30 fps) H.265(HEVC) High/Main Profile @ Up to Level 5.1 (4k2k 60 fps) MPEG1 MPEG4 SP MPEG4 ASP @Level 5 H.264 (AVC) MP@L 4.1	AAC(AAC-LC)(H.264) AC3 Dolby Digital Plus Dolby Digital DTS	External: MicroDVD SRT SSA ASS Subview Vobsub Inside: SSA ASS SRT Vobsub
.ts	MPEG2 MP@HL H.264 High Profile to level 5.1 H.264 Main Profile to level 4.1 H.264 baseline Profile to level 4.0 H.264 HP@Up to Level 4.1 H.264(AVC) MP@L4.1 H.264(AVC) BP@L3.1 H.265(HEVC) Main Profile @ Up to Level 5 (4k2k 30 fps) H.265(HEVC) Main Profile @ Up to Level 5.1 (4k2k 60 fps)	MPEG Audio,support MPEG1 Layer 1/2 & MP3(MPEG2) LPCM Dolby Digital Plus Dolby Digital AC3 MP3 DTS AAC	-
.trp	MPEG2 MP@HL H.264 HP@Up to Level 4.1 H.264(AVC) MP@L4.1	MP3	-
.tp	MPEG2 MP@HL	MP3	-
.m2ts	MPEG2 MP@HL H.264(AVC) MP@L4.0 H.264(AVC) BP@L4.0 H.265(HEVC) Main Profile @ Up to Level 5 (4k2k 30 fps) H.265(HEVC) Main Profile @ Up to Level 5.1 (4k2k 60 fps)	AC3 AAC Dolby Digital	-
.vob .mpeg	MPEG1 MPEG2 MP@HL	LPCM Dolby Digital Dolby Digital Plus	-
.dat	MPEG1 MPEG2	MP3	-
.mov	MPEG4 SP MPEG2 MP@HL MJEPG H.264 HP@Up to Level 5.1 H.264 HP@Up to Level 4.1	Dolby Digital Plus Dolby Digital	-
.flv	H.264 HP10 LV 4.0 H.264 MP10 LV 4.0 H.264 BP LV 4.0 (**2) H.264 HP@Up to Level 5.1 H.264 HP@Up to Level 4.1 MPEG4 SP MPEG4 ASP@Level5 H.264(AVC) MP@L4.1	MPEG4 AAC-LC MPEG1 Layer 1/2	External: MicroDVD SRT SSA ASS Subview Vobsub

Other useful features

File extension	Video decoder	Audio decoder	Subtitle
.mp4	MPEG2 MP@HL MPEG4 SP MPEG4 ASP@Level5 MPEG-4 SP@HL 3.0 & MPEG-4 ASP@HL 4.0 H.264 HP@Up to Level 5.1 H.264 HP@Up to Level 4.1 H.264(AVC) MP@L4.0 H.264(AVC) BP@L4.0 H.265(HEVC) Main Profile @ Up to Level 5 (4k2k 30 fps) H.265(HEVC) Main Profile @ Up to Level 5.1 (4k2k 60 fps)	MPEG1 Layer 1/2 Dolby Digital Plus Dolby Digital MPEG4 (AAC) AAC HE-AAC (AAC+) HE-AAC v2 (enhanced AAC+) MPEG4 (Enhanced Low Delay AAC)	External: MicroDVD SRT SSA ASS Subview Vobsub
.3gp	MPEG2 MP@HL MPEG-4 SP@HL 3.0 & MPEG-4 ASP@HL 5.0 H.264 HP@Up to Level 5.1 H.264 HP@Up to Level 4.1 H.264(AVC) MP@L4.0 H.264(AVC) BP@L4.0 H.263	MPEG1 Layer 1/2 AMR_NB AAC	External: MicroDVD SRT SSA ASS Subview Vobsub
.rmvb	Real Video 8, 9, 10	-	-
.webm	VP8	-	-
DTMB	AVS: Full-HD60P decoder Jizhun Profile @ Level 6.2 (supports 4:2:0 format), Full-HD60P decoder MPEG2 MP@HL H.264 HP@Up to Level 5.1 H.264(AVC) MP@L4.0 H.264(AVC) BP@L4.0	Dolby Digital Plus Dolby Digital MPEG1 Layer 1/2 (MPEG2) MPEG2 (AAC-LC) (H.264) & MPEG4 AAC-LC (H.264) DRA(decode)	-

Supported audio format

File extension	Audio decoder
.mp3	MPEG1 Layer 1/2/3
.wma	WMA WMAPro, WMA V9
.flac	flac
.ogg	VORBIS
.wav	WAVE, PCM
.mka	AC3
.aac	AAC
.m4a	AAC
.mid	MIDI

Supported picture format

File extension	Picture decoder
JPEG	progressive 4000*4000 baseline 8000*8000
PNG	4096*5760
GIF	8000*8000
BMP	8000*8000

NOTE

- USB 1.1 devices may not be played properly.
- Operation using USB hubs is not guaranteed.
- Video in Motion JPEG format with a resolution higher than 1280x720 may not be played back correctly.
- Some file formats in the above list may not be played back correctly (including images, sounds, subtitles, etc.).
- Depending on the bit rate, some files may not be played back.
- The TV supports DTS encoded video files instead of DTS surround sound formats.
- Some subtitles may not be displayed correctly and this may affect the TV operation.
- Only show the compatible file format.
- According to different files the displayed playback time may be slightly different from the actual .
- The length of time information may not be displayed correctly in some file.

Appendix

Troubleshooting

The problems described below are not always caused by malfunctions. Check the TV again before having the TV serviced.

Problem	Possible solution
<ul style="list-style-type: none"> No power. 	<ul style="list-style-type: none"> Is the AC cord disconnected?(See page 13.) Has the power been turned on? (See page 17.) When the power switch does not work, remove the power plug and insert it again, and press ⏻ (POWER) on the TV after waiting more than five seconds.
<ul style="list-style-type: none"> Unit cannot be operated. 	<ul style="list-style-type: none"> External influences such as lightning, static electricity, etc., may cause improper operation. In this case, operate the unit after first turning the power off or unplugging the AC cord and re-plugging it in after 1 or 2 minutes.
<ul style="list-style-type: none"> Remote control unit does not operate. 	<ul style="list-style-type: none"> Are batteries inserted with polarity(+ , -) aligned?(See page 16.) Are batteries worn out? (Replace with new batteries.) Has the remote control been paired? (See page 12.)
<ul style="list-style-type: none"> Picture is cut off. 	<ul style="list-style-type: none"> Are screen mode adjustments such as picture size made correctly?(See page 20 .)
<ul style="list-style-type: none"> Strange colour, light colour, or dark, or colour misalignment. 	<ul style="list-style-type: none"> Adjust the picture tint. (See page 20.) Is the room too bright? The picture may look dark in a room that is too bright. Check the colour system setting. (See page 22.)
<ul style="list-style-type: none"> Power is suddenly turned off. 	<ul style="list-style-type: none"> The unit's internal temperature has increased. Remove any objects blocking the vent or clean. Is the sleep timer, no signal power off ? (See pages 19 and 20.)
<ul style="list-style-type: none"> No picture. 	<ul style="list-style-type: none"> Is the connection to external equipment correct?(See pages 14, 15 and 27.) Is the correct input selected?(See page 26.) Is the picture adjustment correct?(See page 20.) Is the antenna connected properly?(See page 13.) Check the colour system setting. (See page 22.)
<ul style="list-style-type: none"> No sound. 	<ul style="list-style-type: none"> Is the volume too low? (See page 11.) Check the sound system setting. (See page 22.)
<ul style="list-style-type: none"> The TV sometimes makes a cracking noise. 	<ul style="list-style-type: none"> This is not a malfunction. This happens when the cabinet slightly expands and contracts according to changes in temperature. This does not affect the TV's performance.
<ul style="list-style-type: none"> Cannot select the desired channel. 	<ul style="list-style-type: none"> Switch between Digital TV and Analogue TV modes. (See page 26.)
<ul style="list-style-type: none"> Cannot connect to the Network 	<ul style="list-style-type: none"> Is the LAN cable connected correct. (See pages 24 and 25.) Check the "LAN setting".

Cautions regarding use in high and low temperature environments

- When the unit is used in a low temperature space (e.g. room, office), the picture may leave trails or appear slightly delayed. This is not a malfunction, and the unit will recover when the temperature returns to normal.
- Do not leave the unit in a hot or cold location. Also, do not leave the unit in a location exposed to direct sunlight or near a heater, as this may cause the cabinet to deform and the LCD panel to malfunction.
Storage temperature: - 20°C to + 60°C.

Appendix

Specifications

Item		Model	LC-60UA50H	LC-70UA50H
Resolution			8,294,400 pixels (3840(H) x 2160(V))	
Video colour system			PAL / SECAM / NTSC 3.58 / NTSC 4.43 / PAL 60	
TV function	TV-Standard	Analogue	PAL:BG, DK, I SECAM:BG,DK NTSC:MN	
		Digital	DTMB	
	Receiving channel	VHF/UHF	44.25MHz-863.25 MHz	
		CATV	S1-S41ch (including Hyperband)	
	Digital terrestrial broadcast		52.50MHz-866.00MHz	
STEREO/BILINGUAL		NICAM: BG, I, DK ; A2 stereo: BG		
TV tuning system	Analogue		Auto preset 99 channel	
	Digital		Auto preset 999 channel	
Audio amplifier			5W×2 (L / R) +20W (Subwoofer)	
Speaker			Φ28mm x 2 , (30mm x 70mm) x 2 , Φ55mm x 4	
Terminals	Side	USB 1	USB 2.0	
		USB 2	USB 3.0	
		Micro SD	Micro SD	
		HDMI 1	HDMI (HDMI input) (480i, 576i, 480p, 576p, 720p/50Hz, 720p/60Hz, 1080i/50Hz, 1080i/60Hz, 1080p/50Hz, 1080p/60Hz, 1080p/24Hz, 2160p/30Hz)	
		HDMI 2	HDMI (HDMI input) (480i, 576i, 480p, 576p, 720p/50Hz, 720p/60Hz, 1080i/50Hz, 1080i/60Hz, 1080p/50Hz, 1080p/60Hz, 1080p/24Hz, 2160p/30Hz)	
	HDMI 3	HDMI (HDMI input) (480i, 576i, 480p, 576p, 720p/50Hz, 720p/60Hz, 1080i/50Hz, 1080i/60Hz, 1080p/50Hz, 1080p/60Hz, 1080p/24Hz, 2160p/30Hz, 2160p/50Hz, 2160p/60Hz) (Support HDR signals for HDMI 3 only)		
	Rear	Digital Audio Output	Optical digital audio output	
		COMPONENT/AVINPUT	COMPONENT in (480i, 576i, 480p, 576p, 720p/50Hz, 720p/60Hz, 1080i/50Hz, 1080i/60Hz), AUDIO in ; VIDEO in, AUDIO in	
		Special service terminal	Only for service	
		LAN (ETHERNET 10/100)	Network connector	
ANTENNA		UHF/VHF 75 Ω Din type		
OSD language			English/Simplified Chinese/Traditional Chinese	
Power requirement			AC 110-240 V, 50Hz	
Power consumption(Standby)			230W (0.5W)	245W (0.5W)
Weight	Without stand		21.0 kg	27.0 kg
	With stand		22.0 kg	28.0 kg
Operating temperature			0 °C to + 45 °C	
<ul style="list-style-type: none"> As a part of policy of continuous improvement, SHARP reserves the right to make design and specification changes for product improvement without prior notice. 				

Appendix

Dimensional drawings

■ LC-60UA50H

Unit: mm

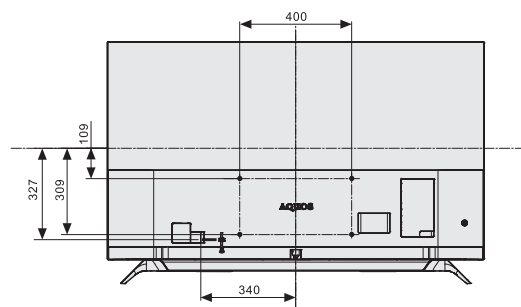
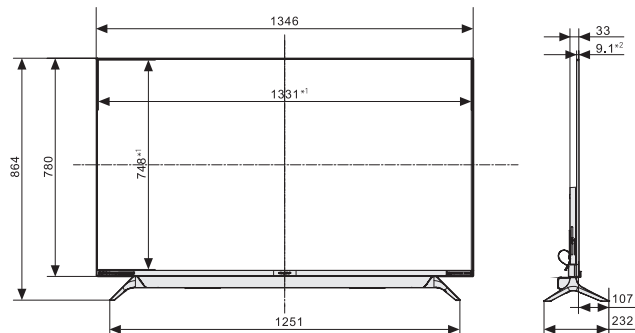

■ LC-70UA50H

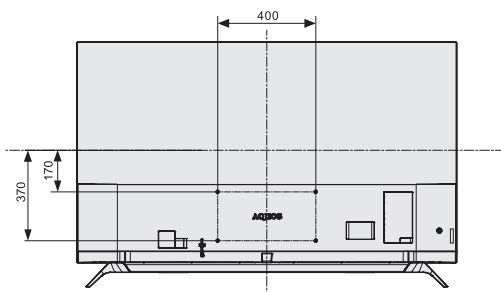
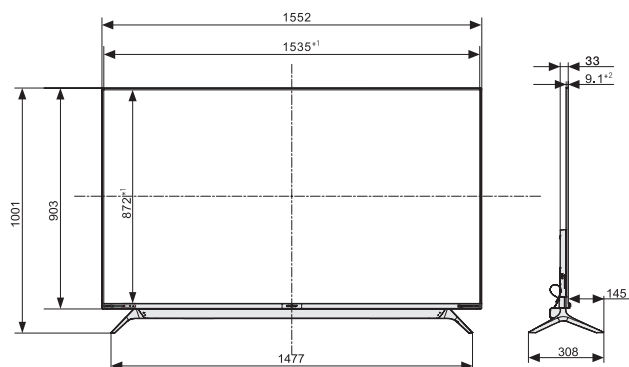

- *1 Active area
- *2 Thinnest part