

SHARP

Window Type Air Conditioner
OPERATION MANUAL
窗口式冷氣機
使用說明書

MODELS: AF-A7UA
型 號: AF-A9UA
AF-A12UA
AF-A18UA

香港電器安全規格

(國際電工委員會規格適合)

Thank you for choosing SHARP window-type air conditioner. Please read this manual thoroughly before using your air conditioner and keep it carefully for future reference.

多謝您購買SHARP窗口式冷氣機。安裝及操作之前，請仔細閱讀本說明書，以便正確使用冷氣機。閱讀後，請妥善保存此說明書，以便日後翻閱。

CONTENTS

Structure mechanism and Installation	Operating Condition	1
	Installation Precaution	2
	Installation	3
Operation procedure	Parts Name	5
	Air Direction Adjustment	5
	Main Control Panel	6
	Air Conditioner Operation	7
	Operation Tips	8
Maintenance	Caution	9
	Maintenance	10
	Trouble Shooting Guide	11

NOTICE:

This appliance is not intended for use by persons (including children) with reduced physical, sensory or mental capabilities, or lack of experience and knowledge, unless they have been given supervision or instruction concerning use of the appliance by a person responsible for their safety. Children should be supervised to ensure that they do not play with the appliance.

The appliance shall be installed in accordance with national wiring regulations. If the supply cord is damaged, it must be replaced by the manufacturer, its service agent or similarly qualified persons in order to avoid a hazard.

Please read this operation manual carefully before operating the unit. The figures in this manual may be different with the material objects, please refer to the material objects for reference.

● Precautions

Warning

Children shall not play with the appliance.

Cleaning and user maintenance shall not be made by children without supervision.

The air conditioner should be installed in accordance with national wiring regulation. Air Conditioner should be properly grounded. Incorrect grounding may cause electric shock.

- This appliance can be used by children aged from 8 years and above and persons with reduced physical, sensory or mental capabilities or lack of experience and knowledge if they have been given supervision or instruction concerning use of the appliance in a safe way and understand the hazards involved.
- Do not connect air conditioner to multi-purpose socket. Otherwise, it may cause fire hazard.
- Install the air switch. If not, it may cause malfunction.
- Do not spill water on the control panel, otherwise it may be broken.
- Do not spray water on air conditioner. It may cause electric shock or malfunction.
- Do not insert fingers or objects into air inlet or air outlet . It may cause personal injury or damage.
- Do not step on air conditioner, or put heavy objects on it. It may cause damage or personal injury.
- Do not block air outlet or air inlet. It may cause malfunction
- Disconnect power supply when cleaning air conditioner. Otherwise, it may cause electric shock.
- Do not repair air conditioner by yourself. It may cause electric shock or damage. Please contact dealer when you need to repair air conditioner.
- Maintenance must be performed by qualified professionals. Otherwise, it may cause injury or damage.
- The appliance is not to be used by persons (including children) with reduced physical, sensory or mental capabilities, or lack of experience and knowledge, unless they have been given supervision or instruction.
- Children should be supervised not to play with the appliance.

Please install the devices for short-circuit protection and electrical leakage protection when installing the air conditioner.

According to the local safety regulations, use qualified power supply circuit and circuit breaker.

Working temperature range

※ Operating Temperature Range		
	Indoor side DB/WB(°C)	Outdoor side DB/WB(°C)
Maximum cooling	32/23	43/-

● Operating Condition

- Please operate air conditioner in the correct conditions as below .

COOL mode operation

Outdoor temperature should be in range of 18°C to 43°C. Room humidity should be lower than 90% .
Otherwise, it is possible for air conditioner to dew at air conditioner surface and even drop water after running for a certain period of time. But this may be normal.



Power Requirement



Rated voltage and voltage range: $\sim 220V \pm 10\%$

* The electric components will be damaged when the voltage is too high.
If the voltage is too low, the compressor will vibrate violently to **damage** the refrigerant system and easily cause the compressor and electric components not working.

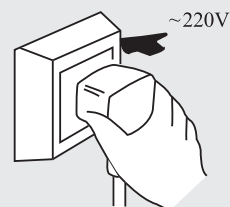

● Installation Precaution

Installation precaution:

Please associate the professional technician to install the unit. Don't install it by yourself.

Location:

- The condensation water must be drained away conveniently.
- Install the air conditioner far away from TV set or radio etc. to avoid disturbing video or voice.
- Avoid a place where inflammable gas is possible to leak out.
- Avoid other heat sources or direct sun light.
- Avoid a place where children can reach the machine easily.

How to install:

- Choose a location where no obstacle is surrounding the unit.
- Prepare the installation hole slightly bigger than unit size.
- Choose the installation space according to the following diagram.

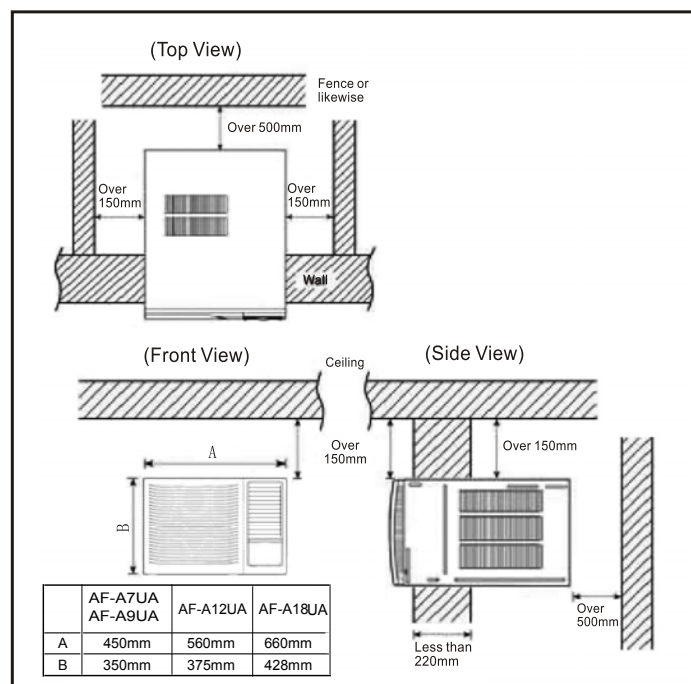

● Installation

Installation procedure:

- 1) Remove the front panel.
- 2) Put the unit into the installation hole.
 - When installing the unit, it should be slanted down to the back to avoid the enlargement of noise or vibration. (Slant between 6-10mm.) (Shown at right figure.)
 - The installation place should be strong enough to avoid the enlargement of noise or vibration.
- 3) Fill up sew in the cabinet with sponge or foam.

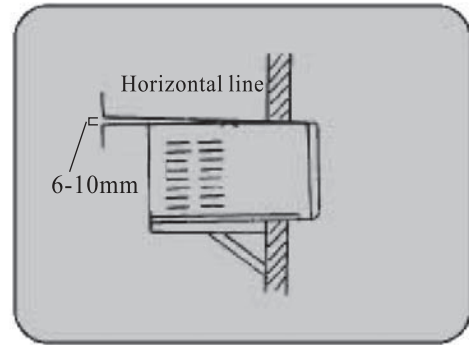

Installation assistance:

- Use strong metal material(e.g.iron)support
The installation hole should be strong enough to support the air conditioner. If not, metal support has to be used outdoors.
Metal support should be fixed on the building.
(Shown at right figure.)
- Use sunshade board
Air conditioner should avoid anything to be dropped into it and avoid direct sunshine. If there is no cover on it, you should contact the seller for installing the sunshade board. When installing the sunshade board, don't let it block the air inlet at the side grille.

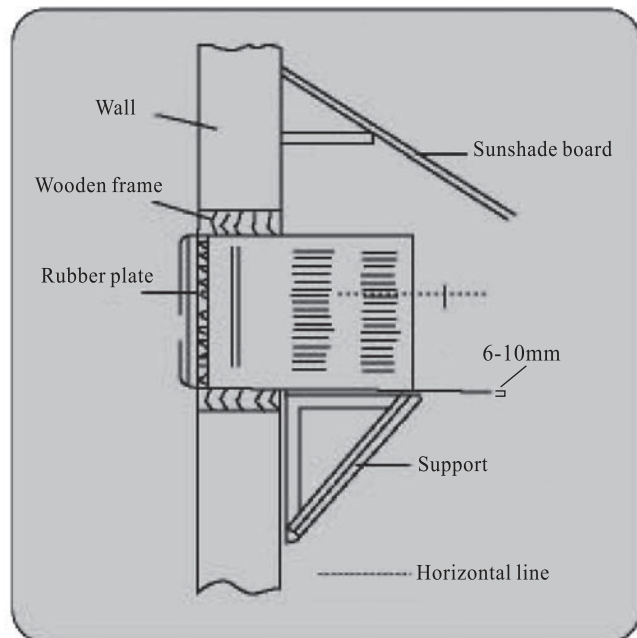

Drain water:

To get the maximum cooling efficiency, the air conditioner is designed to splash the condensation water on the condenser coil.

If the splashing sound annoys you, you can install an outside drain by following procedure, which may however cause a small loss of performance.

1. Slide out the chassis from the cabinet.
2. Remove the rubber plug from the body base plate.
3. Install the drain pan to the corner of the cabinet with 2 screws.
4. Connect the drain hose to the outlet on the drain pan.
5. Slide the chassis into its original place in the cabinet.

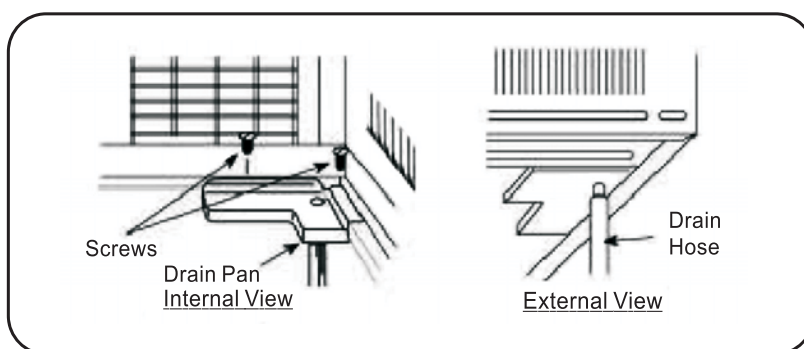

Note:

- Drain hose or tubing can be purchased to satisfy your particular needs.

Notes for installation:

Noise

- Install in a location where it is firm enough to avoid the enlargement of noise and vibration.
- Don't put anything in front of the outlet of unit to avoid increasing noise.
- Be sure that hot air or noise will not cause inconvenience to neighbors.
- Please contact the seller or SHARP authorized service center as soon as there is strange noise during operation.
- Please use strong safety support for the unit.

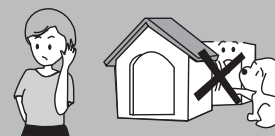

Electric wiring

- Exclusive circuit must be used. But removable socket can't be used because poor contact of it can cause over heat or fire.
- Don't pull the power cord when removing the power plug from socket.
- In fixed circuit, there must be electricity leakage protection switch and leakage current is less than 30mA.



● Parts Name

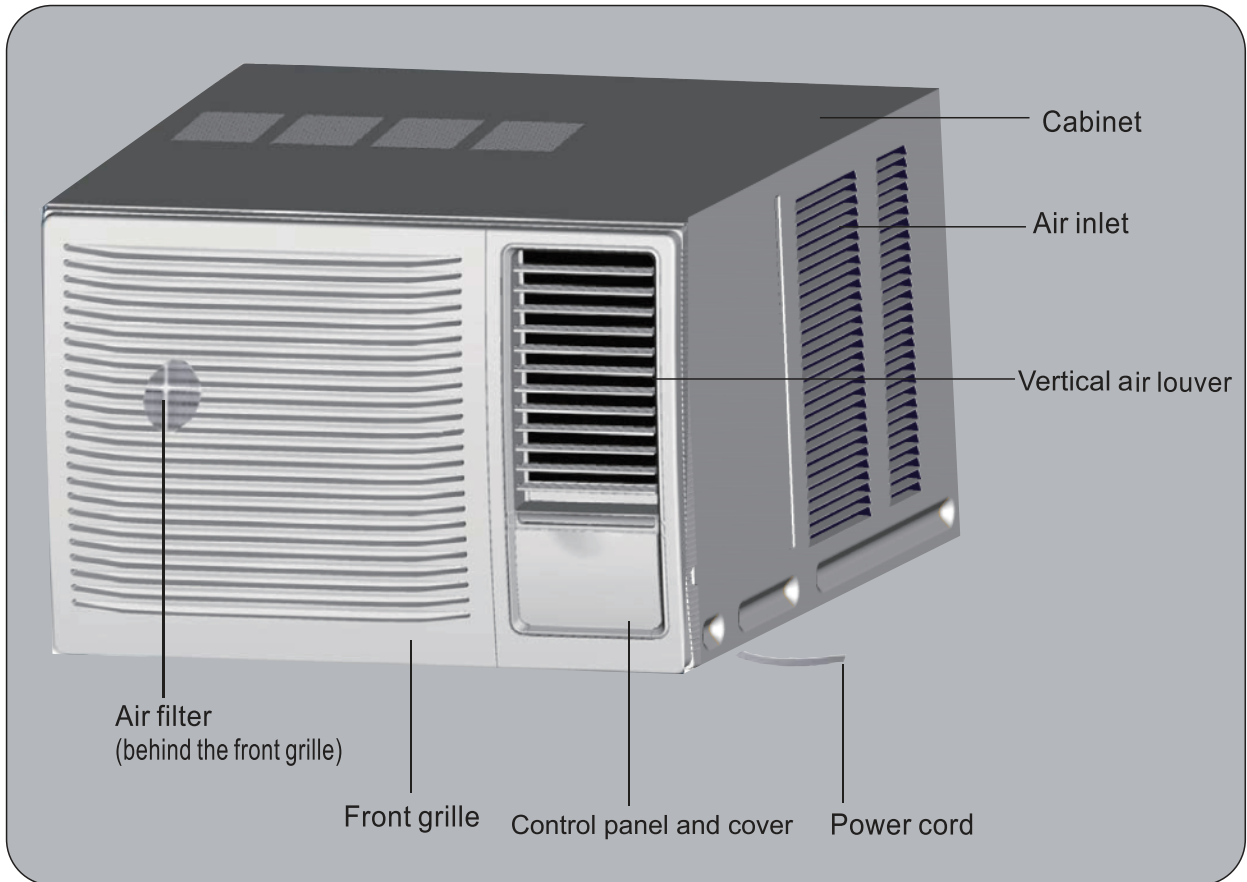

Airflow direction adjustment:

Vertical air louver

Adjust airflow direction up and down.
The vertical air louver is controlled by positioning the louver to discharge the air upwards, downwards or straight out.

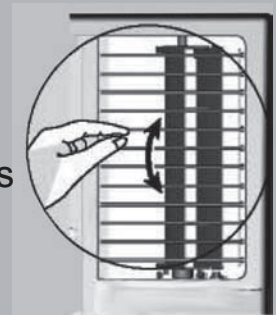

VENTILATION LEVER

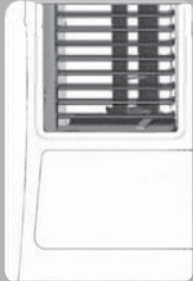

Ventilation Lever

When the slide lever at the:



CLOSE ◀ VENT ▶ OPEN

- "OPEN" position, the ventilation door opens to allow air, smoke or odors to be expelled from the room.

When the slide lever at the:



CLOSE ◀ VENT ▶ OPEN

- "CLOSE" position, the ventilation door is closed and the air will be circulated inside the room and conditioned.

MAIN CONTROL PANEL

Air Swing Switch

AIR SWING OFF  ON

OFF Stops the operation of Air Swing.
ON Air Swing is in operation.

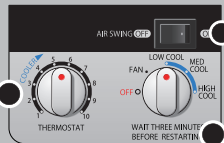

Main Control Knob

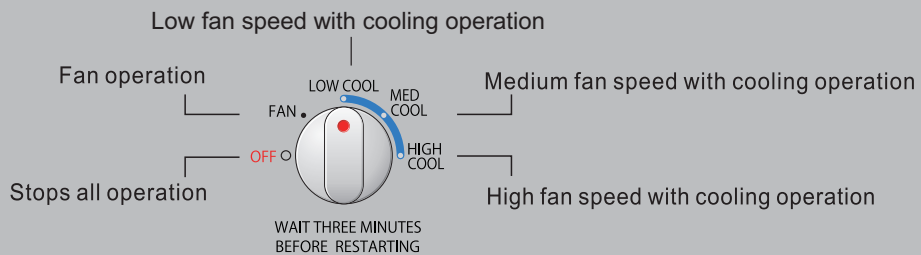

Temperature Control Knob

Turn the temperature control knob as shown:

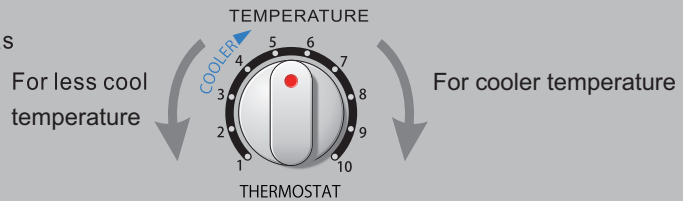

● Air Conditioner Operation

Cooling only



1. Open the control panel cover

2. Power Supply

Switch off the breaker and set the main control knob to the OFF position before plugging the power plug into an electrical outlet.

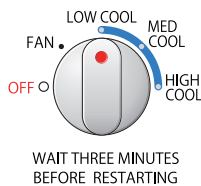

3. Main Control Knob

Set to Low Cool, Med Cool or High Cool as desired.
(FAN setting operates fan operation only.)

CAUTION: If the main control knob is turned off or changed to a fan setting from a cooling operation setting, **WAIT** at least 3 minutes before resetting to cooling operation.

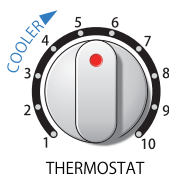

4. Temperature Control Knob

Set the temperature control knob to your desired setting (Usually, 6-7 is recommended). If the room temperature is not as desired after a reasonable period, turn the temperature control knob clockwise to cool the room more or anti-clockwise to cool the room less.

AIR SWING OFF  ON

5. Air Swing Switch

To obtain a fix airflow direction, set the air swing switch to "ON" for the louvers to swing from side to side until the desired flow direction is reached, then switch it to "OFF".
For continuous side-to-side air circulation, set the air swing switch to "ON".

● Operation Tips

Operation for comfort and economy

Do not overcool the room temperature. This is not good for health and wastes electricity.

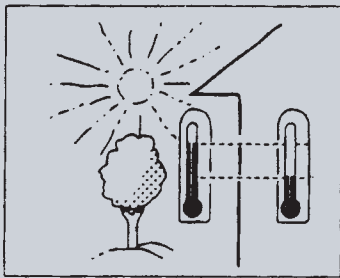

Keep blind or curtains closed. Do not let sunshine enter the room directly when the air conditioner is in operation.

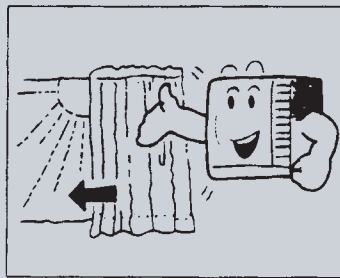

Keep the room temp. uniform. Adjust the vertical and horizontal airflow direction to ensure a uniform temperature in the room.

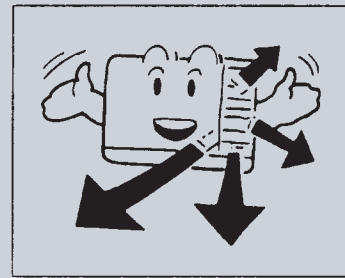

Make sure that the doors and windows are tightly closed.

Avoid opening doors and windows oftenly to keep air conditioning in the room.

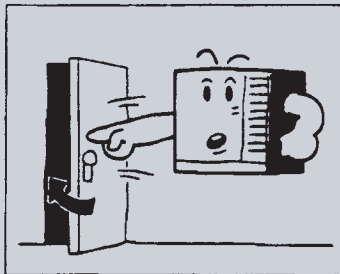

Clean the air filter regularly.

Blockages in the air filter reduce cooling effect.

Clean the air filter at least once every two weeks. (Please refer to Page 10)

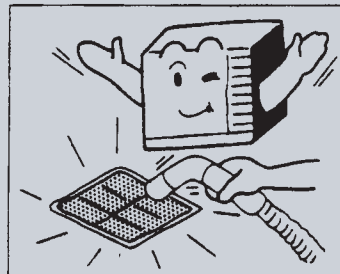

Ventilate the room occasionally.

Since windows are kept closed, it is a good idea to open them and ventilate the room now and then. When starting the unit, curtains or windows should be closed to prevent the cool air leakage.

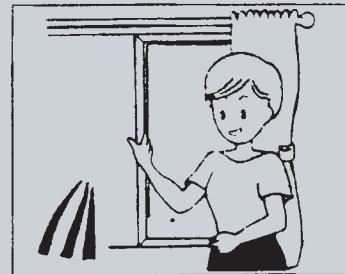

● Caution

- Do not pull on the power cord. Damage to the cord may result in serious electric shocks.
- Do not use the air conditioner for other purposes except for cooling the room, such as drying clothes, preserving foods, or cultivating vegetables.
- Do not block the air intake and outlet vents. This causes lowered performance and irregular operation.
- Do not insert sticks or other objects into the vents as it is dangerous to touch the electric components and the fan.

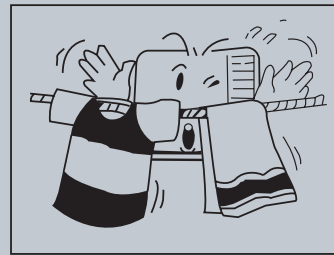
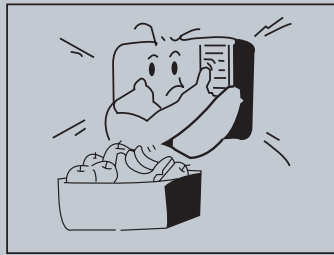
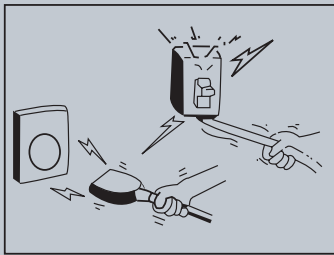

Select the most appropriate temperature. Pay attention to adjust the temperature to suit the conditions. Rooms occupied by infants, the elderly, or the sick should be kept at an appropriate temperature.

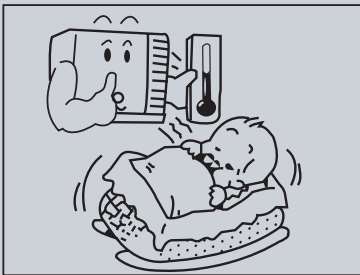

Do not use heating apparatuses in the vicinity. The air conditioner's plastic parts will melt if exposed to excessive heat.

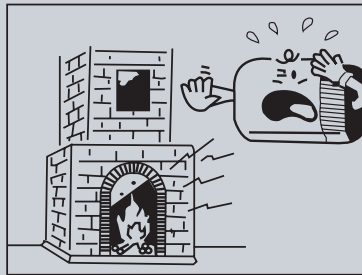

Avoid exposing the body directly to a continuous unidirectional air flow for long periods. This is not recommended for health reason.

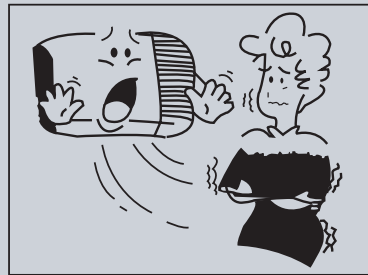

Always wait at least 3 minutes before switching the air conditioner on again after you have switched it off during cooling.

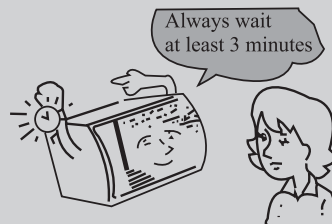

Maintenance

Always turn off the air conditioner and main power supply before cleaning to ensure safety.

Cleaning

Main unit

1. Turn power off before cleaning.

Plug out only after air conditioner stops at all.

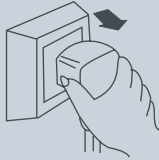

2. Use soft cloth when cleaning cabinet.

If the cabinet is very dirty, dip cloth into warm water below 40°C, dry the cloth and then rub off the dirt.



Dry the cloth by hands before cleaning.

3. Don't use gas, benzene, or other chemical solvent, etc. for cleaning.



4. Do not splash water directly on indoor unit, in which there are micro-computer and circuit plate, they must not be drenched with water.



Accident could happen.

Air filter

The air filter behind the grille should be washed at least once every two weeks or as often as it needs cleaning.

How to clean the air filter:

1. To remove the air intake grille, grasp the tab on the filter and pull to take out.

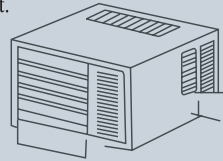

2. Vacuum the filter on the dusty side to remove light dust.

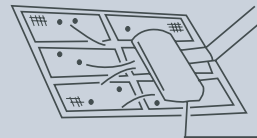

Vacuum cleaner

3. Wash the filter, cleaner side up under gently flowing water to wash out accumulated dust and lint.



4. If the filter is very dirty, use a mild household detergent in the wash water.



Let the filter dry thoroughly before reinstalling it.





* Check if air inlet and outlet of unit are blocked or not.

Air block could result in bad efficiency.



● Trouble Shooting Guide

Please check the following items before asking for repair, it saves your time and money.

Fault phenomenon	Trouble-shooting
<p>Air conditioner dose not operate at all.</p> 	<ul style="list-style-type: none"> * Is there a power failure? * Is the plug out? * Is power fuse or switch off? * Is voltage higher than 242V or lower than 198V?
<p>Cool efficiency is not good.</p> 	<ul style="list-style-type: none"> * Is air inlet or outlet blocked? * Is there any other heat sources in room? * Are air filters dirty very much? * Is indoor fan speed set at LOW? * Maybe the room is too hot when the unit is started, please cool down the room after a period of time.
<p>Foggy air flows out.</p> 	<ul style="list-style-type: none"> * At COOL mode operation, sometimes there is foggy air flowing out of indoor unit, this is because the room humid air has been cooling rapidly. * The unit is normal while the indoor outlet is sending out some odor, because the inlet air may be mixed with the smell of furniture and smoke.
<p>The air conditioner operation is noisy.</p> 	<ul style="list-style-type: none"> * For a noise that sounds like water flowing: This is the sound of freon flowing inside the air conditioner unit. * For a noise that sounds like a shower: This is the sound of the dehumidifying water being processed inside the air conditioner unit.
<p>It seems that condensation is leaking from air conditioner.</p>	<ul style="list-style-type: none"> * Condensation occurs when the airflow from the air conditioner cools the warm room air.
<p>Air conditioner dose not operate for about 3 minutes when restart.</p>	<ul style="list-style-type: none"> * This is to protect the mechanism. * Wait about three minutes and operation will begin.

Immediately stop all operations and plug out, please contact **SHARP authorized service center** in the following situations.

- *Operation starts or stops abnormally;
- *Power fuse or switch often breaks;
- *Carelessly splash water or something into air conditioner;
- *Electrical lines are much hot or lines cover breaks;
- *Other strange situations.



目 錄

注意事項	操作時注意事項	1
	安裝時注意事項	2
	安裝方法	3
操作方法	各部分名稱	5
	風向調節	5
	操作面板	6
	操作方法	7
	操作提示	8
保養	注意事項	9
	保養	10
	故障時的檢查事項	11

注意：

除非得到監護人或負責其安全人士的適當監督或指導，否則本機不適合身體官能或心智能力退化者，或缺乏操作經驗和知識的人士（包括兒童）使用。請監督並確保兒童不會把玩本機。

產品的安裝需符合規範。若發現電源線破損，請務必聯繫生產商、銷售商或其他專業維修人員進行替換，以免發生危險。

在使用本產品前請仔細閱讀本使用手冊。若手冊內部分數據與產品實物不同，請以產品實物為準。

◎ 注意事項

⚠ 警告

請勿讓兒童把玩本產品。

在無監督的情況下，不得由兒童進行清潔或保養。

請按照規範安裝本產品。冷氣機需要確保良好接地，不正確的接地可能導致觸電危險。

- 在有人指引及保護之情形下，8歲及以上之孩童、有身體、感覺及心智功能不足者及缺乏相關產品使用經驗及知識者，可以在瞭解相關安全警示後安全使用本產品。
- 冷氣機需要連接在專用插座之上，請不要將本產品連接在多功能插座上，否則可能引起火警。
- 需安裝空氣開關（電磁斷路器），否則可能導致故障。
- 請勿將水灑到控制面板上，否則可能導致控制面板故障。
- 請勿將水灑到冷氣機上，否則可能導致觸電事故或機器故障。
- 請勿將手指或其他物品插入冷氣機內部（進風口及出風口等），否則可能導致人身傷害或財產損失。
- 請勿站立在冷氣機上，或將重物置於其之上，否則可能導致機器損壞或人身傷害。
- 請勿堵塞冷氣機進風及出風口，否則可能導致故障。
- 在清潔機器之前，請拔出電源線，否則有觸電風險。
- 除非得到監護人或負責其安全人士的適當監督或指導，否則本機不適合身體官能或心智能力退化者，或缺乏操作經驗和知識的人士（包括兒童）使用。請監督並確保兒童不會把玩本機。
- 請勿嘗試自行修理冷氣機，否則可能導致觸電或其他人身傷害。若需要維修，請聯繫本產品銷售商進行處理。
- 本產品應由專業人士進行保養，不適當的操作可能導致產品損壞或人身傷害。
- 請監督並確保兒童不會把玩本產品。

在安裝本產品時，需要安裝短路保護裝置及漏電保護電路。

依據當地安全法規，使用合格的電源斷路器。

工作溫度範圍

※運行溫度範圍		
	室內側 DB/WB (°C)	室外側DB/WB (°C)
最大製冷	32/23	43/-

● 操作時注意事項

- 請依以下環境操作冷氣機。

製冷模式

室外溫度範圍應在 18°C 至 43°C 之間，否則可能會出現故障。

室內濕度應當低於 90%。否則，冷氣機表面將有水滴凝結，以致長時間不斷滴水。
這是正常現象。



電源要求



額定電壓和電壓範圍：~220V ± 10%

- 當電壓過高時，電子零件將會被損壞。
如果電壓過低，壓縮機會產生劇烈震動，並損壞製冷系統，導致壓縮機與電子零件無法操作。

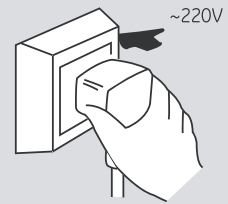

● 安裝時注意事項

安裝注意事項：

請聯繫專業人員來安裝，切勿自行安裝。

安裝場所：

- 冷氣機的冷凝水必須排放到適當的地方。
- 爲了避免對視頻或聲頻造成干擾，冷氣機的安裝應遠離電視機或收音機等。
- 避免安裝在易燃氣體有機會泄漏的地方。
- 避免安裝在有熱源設備或太陽直射的地方。
- 避免安裝在小孩容易接觸到的地方。

如何安裝：

- 選擇一個沒有任何障礙物阻擋的地方。
- 準備一個稍大過機殼的安裝位置。
- 請按下圖選擇安裝空間。

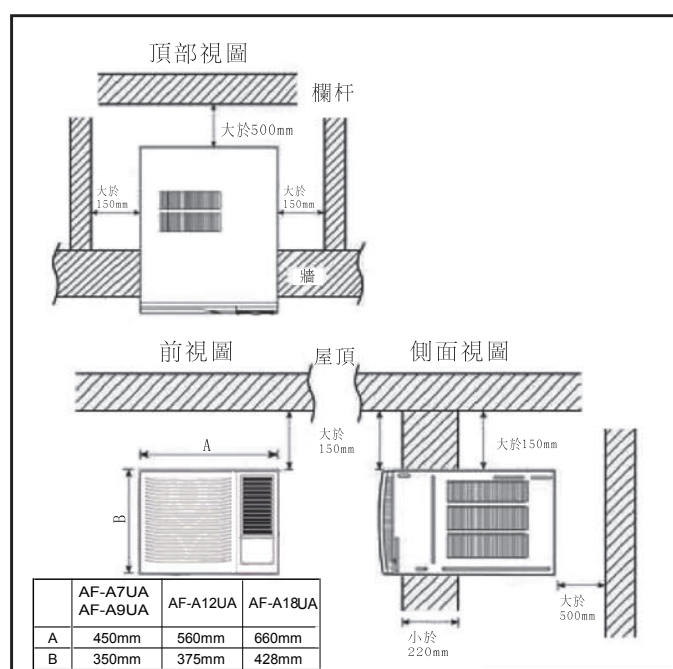

● 安裝方法

安裝步驟：

- 1) 取下前面板。
- 2) 將冷氣機放入安裝位置內。
 - 當安裝時，需稍稍傾斜底部以免噪音及震動聲擴大。(傾斜 6-10 mm)
 - (如右圖所示)
 - 安裝位置應足夠堅固，以避免噪音及震動的擴大。
- 3) 用海綿或泡沫填充縫隙。

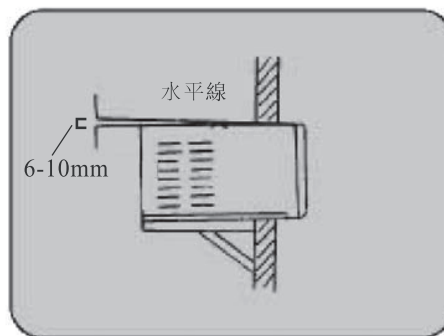

安裝建議：

- 使用鐵支撐架
安裝位置應足夠堅固，以能支撐冷氣機，如果不能，就應使用支撐架。
鐵支撐架應固定在建築物上(如右圖所示)
- 使用遮光篷
冷氣機應當避免任何物體墜落，而且應避免陽光直射，如果無任何防護設施，可與經銷商聯繫安裝遮光篷。安裝遮光篷時，應注意不要阻擋冷氣機側面的進氣口。

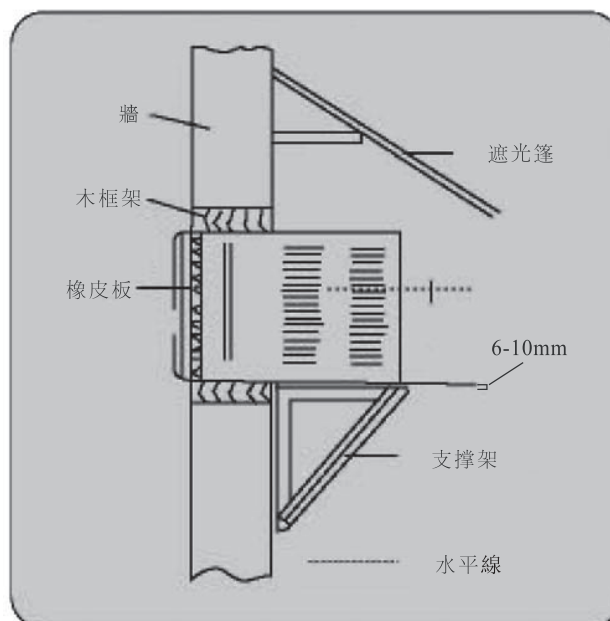

排水：

為達到最大製冷效果，冷氣機內冷凝水應噴灑在冷凝器上

如果噴灑聲音造成滋擾，可以採用如下程序進行室外排水，然而這樣會引起少量的性能減弱。

1. 把底架從機殼滑拉出來。
2. 從機殼底盤取出橡皮塞子。
3. 在機殼的角落處安裝排水盤，用兩顆螺釘固定。
4. 將排水管連接排水盤底部的排水口。
5. 將底架滑移至機殼內的原來位置。

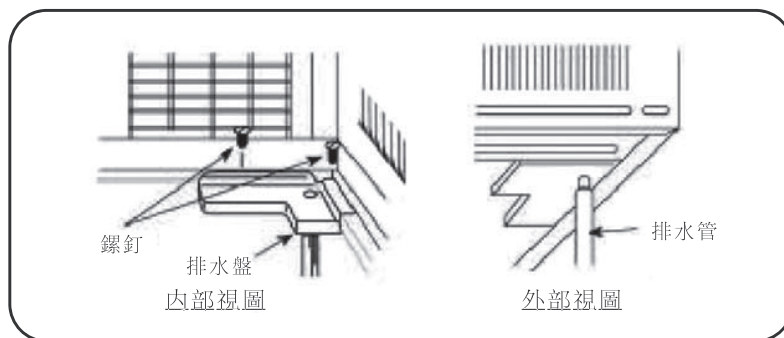

注意：

- 您可按照個人所需購買排水管或水喉。

安裝注意事項：

噪音

- 安裝地點必須足夠堅固，以避免操作時所發出的噪音及震動聲。
- 不要將任何物品放置在冷氣機的出風口以免造成噪音。
- 確保冷氣機的熱氣及噪音不會影響鄰居。
- 如在使用過程中出現奇怪的聲音，請與經銷商或SHARP公司特約維修中心聯繫。
- 請使用堅固的安全支撐架。

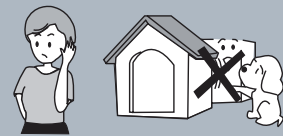

接駁電源線

- 必須使用專用電插座。請勿使用可移動式插座，否則可能引致接觸不良而引起過熱或火災。
- 當拔掉電源插頭時，必須緊握插頭而不要拉扯電源線。
- 在固定電路中，必須有漏電斷路掣而泄漏電流要少於30mA。



● 各部分名稱

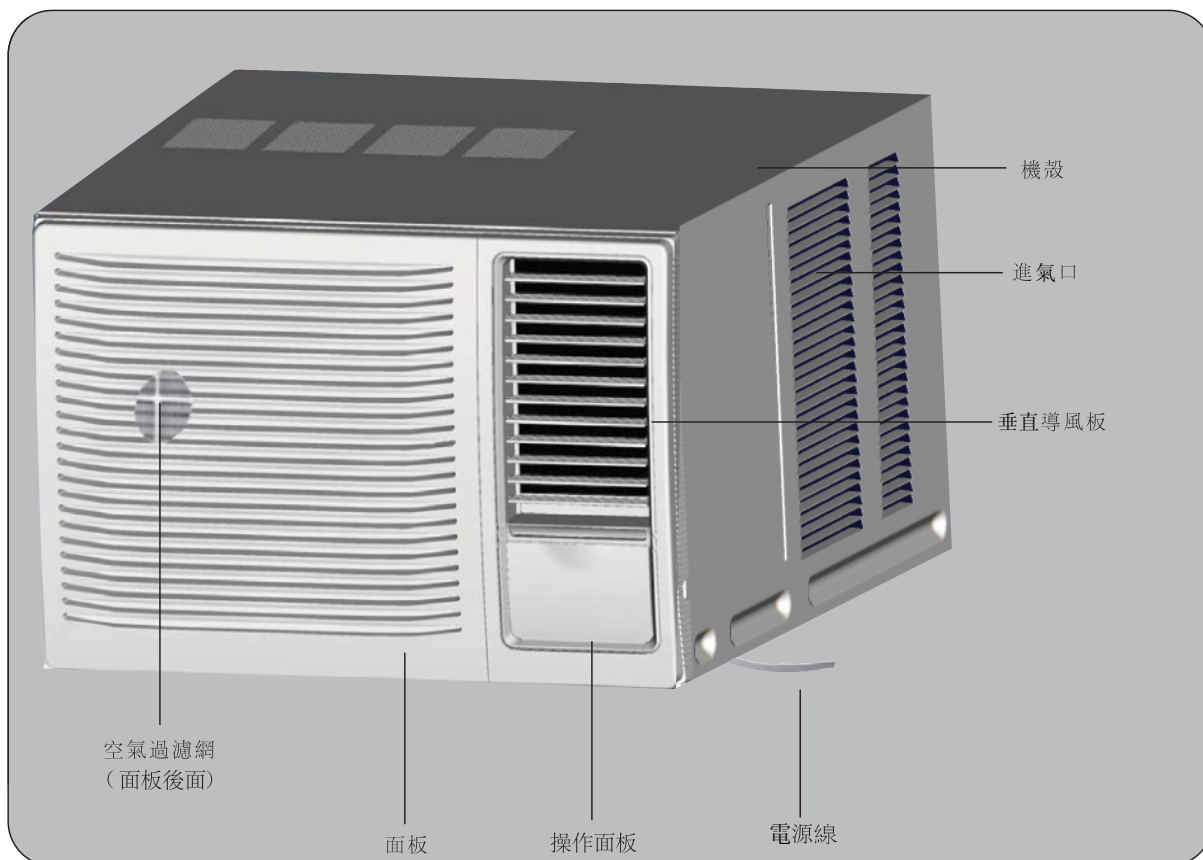

風 向 調 節

垂直導風板

氣流方向可向上向下調校

垂直導風板是用來控制向上、向下或是垂直的出風方向。

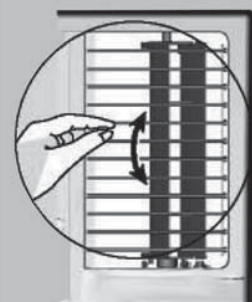

● 操作面板

通風換氣桿



通風換氣桿

當滑動桿處於：



關 ◀ 通風 ▶ 開

- “開”位置，通風口將打開讓空氣、煙霧或異味排出房外。

當滑動桿處於：



關 ◀ 通風 ▶ 開

- “關”位置，通風口將關閉以調節循環房間內的空氣。

操作面板

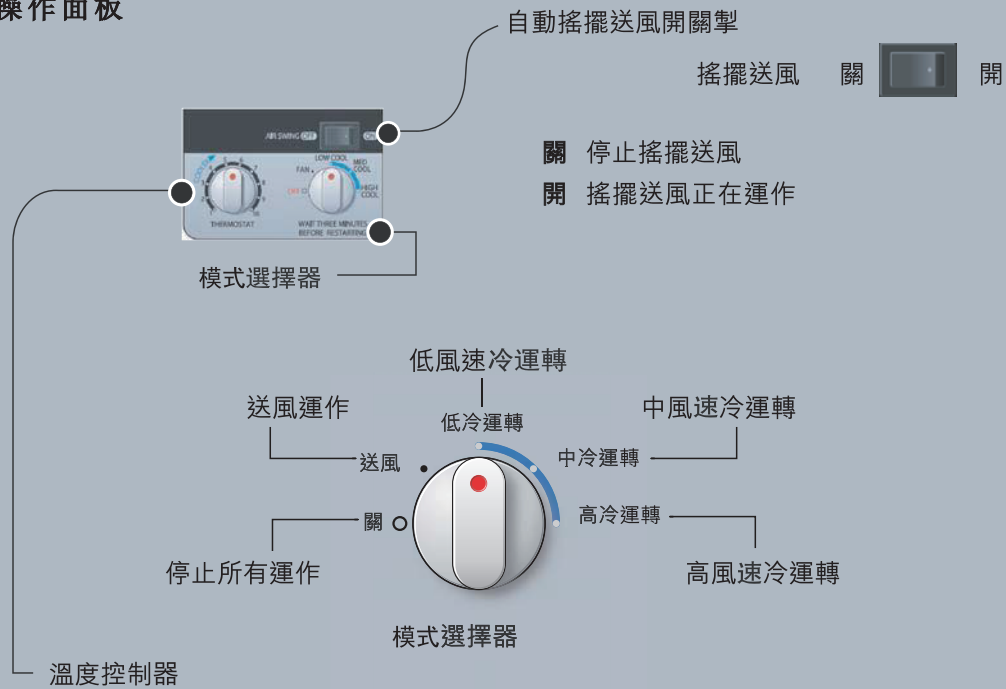

如圖所示旋轉溫度控制器：



● 操作方法

淨冷型



1. 打開操作面板蓋

2. 電源

將插頭插入電插座之前，先關掉斷路器及將模式選擇器調至“關”。



3. 模式選擇器

按所需設置低冷，中冷或高冷。
(送風設定只將進行送風運作。)

注意：如果模式選擇器是關閉的，或從製冷設置轉化為送風設置，若要重新設置製冷運作，請最少需等3分鐘。



4. 溫度控制器

按所需設定溫度控制器(6-7為一般所建議的設定位置)。如果經過一段合理時間，室內溫度仍不能達到滿意效果時，請順時針旋轉溫度控制器以獲得較低的室溫，或反時針旋轉以獲得較高的室溫。

5. 搖擺送風開關掣

搖擺送風 關  開

要固定風向時，請先將開關掣設定為“開”直至獲取所要的風向，然後再將它設為“關”。
要持續搖擺送風時，請設定為“開”。

● 操作提示

舒適經濟的操作

房內溫度請勿過冷。這樣對健康造成不良影響及浪費電力。

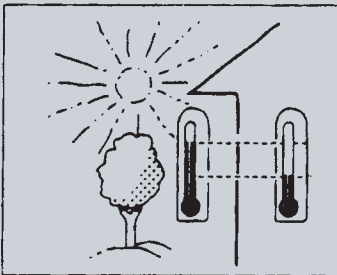

在冷氣機操作過程中，**勿讓陽光直射進室內**，請使用百葉窗及窗簾。

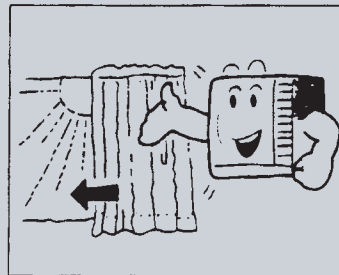

請保持室內溫度一致。調整垂直和水平風向確保室內溫度一致。

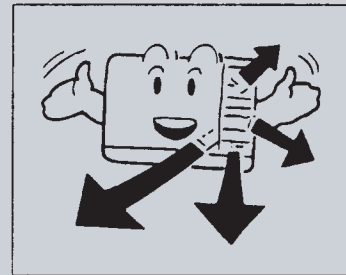

確保門窗都關好。為保證室內冷氣環境，盡可能不要過多開關門窗。

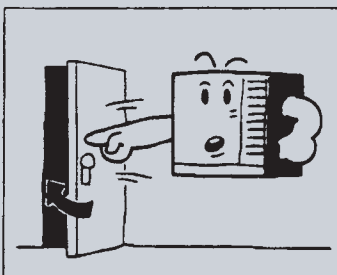

請經常清潔空氣過濾網。過濾網中阻塞物會影響製冷效果。請至少兩星期清洗一次過濾網。（請參看第 10 頁）

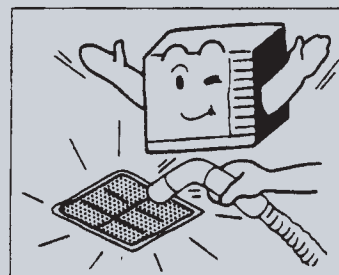

偶爾使室內通風。因窗被緊閉，最好時而將它們打開使室內通風。當冷氣機正在運作時，為防止冷氣從房內流出，請關好門窗或拉好窗簾。

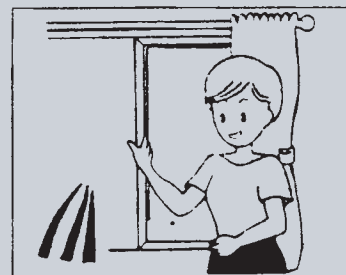

● 注意事項

- 請勿拉扯電源線。破損的電源線可能引致重大觸電事故。
- 除了為房間製冷外，請勿將冷氣機用作其它用途，如晾乾衣物，食物保鮮或蔬菜栽培等。
- 請勿阻擋冷氣機的進出風口。這會引致性能減弱及不規則運作。
- 請勿將木棒類或其它物體插入進出風口以及觸摸電器原件或風扇，這樣會造成危險。

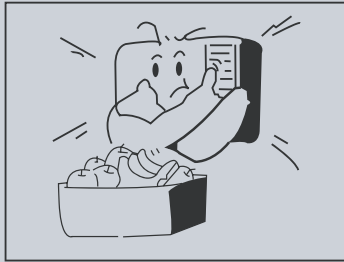
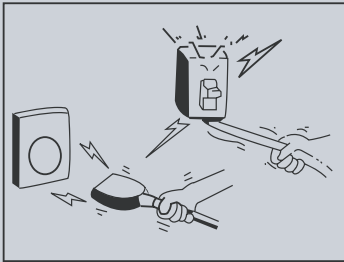

選擇最適合的溫度。
請注意適當調節溫度。
如房內有嬰兒，老人或病人，
請調節適當的溫度。

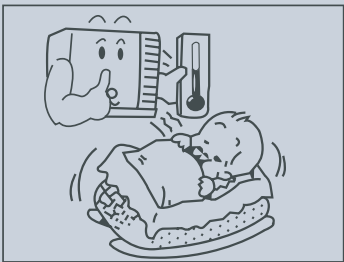

請勿在冷氣機的附近使用加熱設備。如有過多熱量散發，冷氣機的塑料部件會融化。

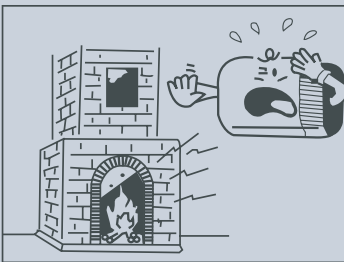

請避免將冷氣機的出風口長時間直接對着身體吹送。
這對健康可能造成不良影響。

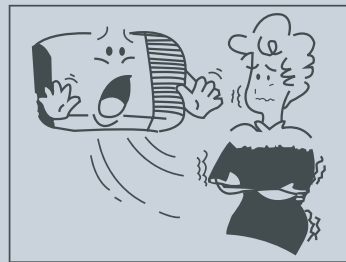

冷氣機停止動作後，最少需要等待3分鐘才可重新開機。

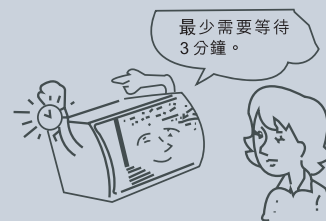

● 保養

請在清潔前先關閉冷氣機及切斷主電源，以確保安全。

清潔

主機

1. 在清潔前先切斷電源。

待冷氣機完全停止運作時才能拔出插頭。

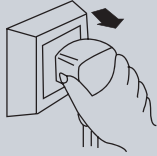

2. 請使用柔軟的布清潔機殼。

如機殼上有很多污垢，可以將布先浸在 40°C 以下溫水中，弄乾後擦拭機殼上的污垢處。



在清潔前先用手將布弄乾。

3. 請勿使用汽油，含苯等化學溶液清潔。



4. 請勿直接向冷氣機噴水，冷氣機內部有微電腦及電路板，絕對不能受潮浸濕。



可能引發事故

過濾網

面板後的空氣過濾網應當經常清洗，或至少每兩星期清洗一次。

如何清洗過濾網：

1. 揭開面板，按住過濾網上掛鉤，然後推動並取出過濾網。

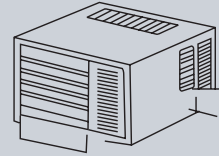

2. 使用吸塵機吸去過濾網上的灰塵。

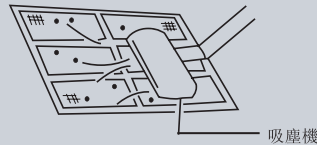

3. 在流水中滴入少量清潔劑清洗過濾網上吸附的灰塵。



4. 如果過濾網十分髒，可以在水中用少許中性家用清潔劑。



待過濾網完全晾乾後，方可重新安裝。





*檢查冷氣機的進氣口及出風口是否堵塞。

空氣受阻將會影響製冷效果。



● 故障時的檢查事項

在委託維修前先檢查以下部分，以節省時間及金錢。

異常現象	操作檢查
冷氣機完全無法運作。 	<ul style="list-style-type: none"> • 電源是否接通？ • 插頭是否鬆動？ • 電源保險絲溶斷或開關掣關閉？ • 電壓是否高於 242V 或低於 198V？
製冷效果不佳。 	<ul style="list-style-type: none"> • 冷氣機進氣口或出風口是否被堵塞？ • 在房內是否有其它熱源物件？ • 過濾網是否過髒？ • 冷氣機風速設置過低？ • 當冷氣機正在運行時如室內溫度過熱，請先讓室內溫度降低一段時間。
有霧氣排出。 	<ul style="list-style-type: none"> • 在製冷模式下，冷氣機有薄霧散出，這是由於室內潮濕空氣驟降而形成的。 • 當室內出風口有異味散出，屬正常現象，是由於冷氣機所吸入的空氣與室內家具及煙霧混合而產生的。
冷氣機運作時有噪音。 	<ul style="list-style-type: none"> • 有像流水一樣的雜音： 這是冷氣機內雪種流動時的聲音。 • 有像灑水的雜音： 這是冷氣機內抽濕的水份在運作時的聲音。
冷氣機冷凝水外漏。	<ul style="list-style-type: none"> • 當冷氣機的氣流使室內的暖空氣冷卻時，可能因此形成冷凝水滴
冷氣機的重新啟動時間需3分鐘。	<ul style="list-style-type: none"> • 這是用來保護機械裝置。 • 機器需大約三分鐘開始運轉。

如有以下情況發生，請立即停止所有操作並拔出插頭，並與經銷商或SHARP公司特約維修中心聯繫：

- * 冷氣機啓動或停止操作異常；
- * 電源保險絲或開關經常燒毀；
- * 不小心將水或異物噴灑到冷氣機內；
- * 電源線過熱或經常跳閘；
- * 其它異常情況。





SHARP[®]

SHARP CORPORATION



66129924456