

# SHARP

重要



中文



## R-230S(B) / R-330S(B) 800 W / 900 W

微波爐

使用說明書

本說明書包含重要資訊，請在使用微波爐前仔細閱讀。

**重要事項：**如未有按此說明書使用微波爐，或微波爐經改裝而在爐門開啟下運作，可能對健康構成嚴重威脅。





使用說明書	
目錄 .....	1
規格 .....	1
微波爐及配件 .....	2
控制板 .....	3
重要安全須知 .....	4-6
安裝事宜 .....	6
使用之前 .....	6
設定時鐘 .....	7
微波強度 .....	7
自選烹調操作 .....	8
微波烹調 .....	8
其他簡便功能 .....	9
翻熱指引 .....	10
解凍指引 .....	11
計時解凍及重量解凍操作 .....	12
自動食譜功能操作 .....	12
自動食譜功能表 .....	13
微波爐適用的器具 .....	14
保養及清潔 .....	15
問題解決 .....	16



型號名稱:	R-230S(B)	R-330S(B)
交流電壓	: 220V, 50 Hz	: 220V, 50 Hz
電力消耗 : 微波烹調	: 1270瓦	: 1450 W
輸出功率 : 微波烹調	: 800瓦	: 900 W
待機模式 (省電模式)	: 少於 1.0 瓦	: 少於 1.0 瓦
微波頻率	: 2450 MHz*	: 2450 MHz*
外部尺寸 (闊) x (高) x (深) 毫米	: 440 x 259 x 324	: 513 x 307 x 394
爐箱內尺寸(闊) x (高) x (深)**毫米	: 306 x 206 x 304	: 368 x 206 x 328
容量	: 20 公升**	: 25 公升**
轉盤直徑	: $\varnothing$ 255 毫米	: $\varnothing$ 315 毫米
重量	: 約 11 公斤	: 約 14.5 公斤

- \* 本產品符合歐洲標準 EN55011 要求。  
根據此標準，本產品被歸類為第二組乙類設備。  
第二組表示此設備有目的地產生電磁輻射形式的無線電頻率能量，以進行食物加熱。  
乙類表示此設備適合家居環境使用。

- \*\* 微波爐內部容量是根據最大闊度、深度和高度而計算的。實際存放食品的能力較少。

備註：設計及規格如有更改，恕不另行通知。



## 微波爐及配件

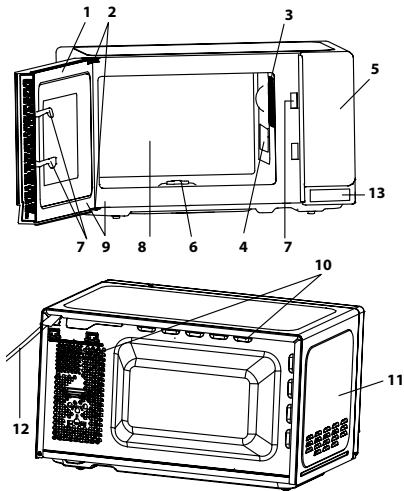

### 微波爐:

1. 爐門
2. 門鉸
3. 照明燈
4. 波導管罩 (請不要拆出)
5. 控制板
6. 轉盤電動軸
7. 門鎖
8. 爐箱
9. 爐門密封襯墊和襯墊表層
10. 通風口
11. 外箱
12. 電源線
13. 開門按鍵

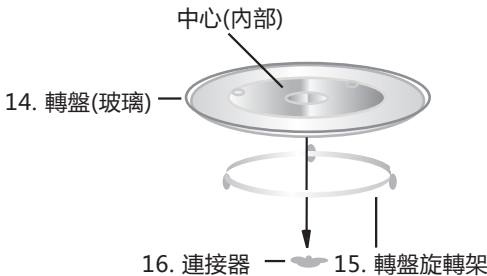

### 配件:

請檢查確定以下配件已齊備:

(14) 轉盤 (15) 轉盤旋轉架 (16) 連接器  
將轉盤旋轉架放在爐底中央，並可在連接器上任意旋轉。然後，將轉盤放在旋轉架上，讓它穩定在連接器上。

為避免轉盤受損，在把食物和容器從爐內取出時，請確定不會觸及轉盤邊緣。

注意：當訂購配件時，請向SHARP客戶服務中心聯絡並兩項資料：配件名稱及型號名稱。

### 注意：

- 波導管罩容易損壞，當清潔微波爐內部時，請小心不要令它受損。
- 每次使用微波爐，必須把轉盤及旋轉架妥為放好。這樣烹調時更可均勻。未放好的轉盤可能會發出聲響、旋轉不良，並可能損壞微波爐。
- 每次烹調時，所有食物和容器必須放在轉盤上。
- 轉盤可順時針或逆時針旋轉。每次使用微波爐時，旋轉方向都可能不同。這不會影響烹調效果。

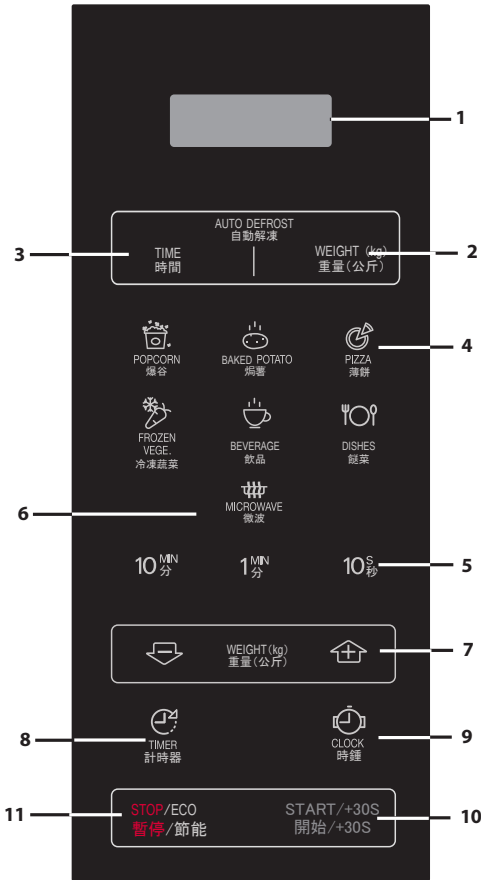

1. 數字顯示屏
2. 重量解凍鍵
3. 計時解凍鍵
4. 自動食譜功能



5. 時間鍵:  
按此鍵以輸入時間；  
持續按鍵以連續增加時間。
6. 微波強度鍵：  
按這個鍵可選擇微波強度
7. 重量選擇鍵 (增加或減少):  
按此鍵以增加/減少重量，  
持續按鍵以增加/減少
8. 計時器鍵:  
按這個鍵可設置分鐘計時器
9. 時鐘鍵
10. 即時烹調/開始鍵
11. 暫停/取消鍵



## 重要安全須知

重要安全須知：請細心閱讀，並保留作將來參考之用。

為防失火危險：

在微波爐操作期間，應小心看管。如所選微波強度太猛，或烹調時間過長，均有可能過熱而起火。

- 本微波爐設計僅限於在桌面上使用，而不適合內置於廚櫃之中。請勿把微波爐放在廚櫃內。
- 電源插口必須隨時可以觸及，以備緊急時易於拔除插頭。交流電源必須為 220 伏特，50Hz，並備有最少 10A 配電線路熔斷器，或最少 10A 配電斷路器。
- 請為此設備提供專用獨立電源。
- 請勿將微波爐放於熱源位置，如傳統焗爐附近。
- 請勿將微波爐安裝於濕度高或濕氣積聚的位置。
- 請勿在戶外存放或使用本微波爐。

如見到有煙冒出，請關掉微波爐、拔除電源，並保持爐門關閉，以遏止任何可能出現的火焰。

僅可使用適用於微波爐的容器及用具，請參閱 C-14 頁。用具應經過檢查，以確定它們適用於微波爐。

在烹調以塑膠或紙盛載的食物時，由於它們屬易燃性質，請留意微波爐的情況。

在使用後，請清潔波導管罩、爐壁、轉盤及轉盤旋轉架。它們必須乾爽及沒有油脂，如油脂積聚，可能會過熱，並冒煙或起火。

- 請勿在微波爐附近或通風口放置易燃物品。
- 請勿遮擋通風口。
- 請移除食物及其包裝上的所有金屬封口及線圈等。在金屬表面形成的電弧可能會起火。
- 請勿使用微波爐加熱食油以作油炸烹調。食油的溫度會不受控制並可能燃燒。
- 如欲烹調爆谷，必須使用供微波爐專用的爆谷袋子。
- 請勿在微波爐內儲存食物或任何其他物品。
- 在啟動微波爐後，請檢查有關設定以確保其操作符合要求。
- 為避免過熱及起火，在烹調或加熱高糖份或肥膩食物，如香腸卷、餡餅或聖誕布甸時，請特別小心注意。

為避免可能導致受傷的情況：

警告：

如微波爐已損毀或操作異常，請勿使用。在使用前，請檢查以下事項：

- a) 爐門；請確定爐門已關妥，並沒有對位不齊或變形。
- b) 門鉸及安全門鎖；檢查以確定它們沒有損壞或鬆脫。
- c) 爐門密封襯墊和襯墊表層；確定它們沒有受損
- d) 爐內壁或爐門；確定沒有損毀。
- e) 電源線及插頭；確定沒有損毀。

如爐門或密封襯墊受損，在由 SHARP 授權之合格服務技術人員修理妥當之前，請勿使用。

請勿自行調校、修理或修改微波爐。除了接受過 SHARP 訓練之合格服務技術人員外，任何人試圖拆除防止微波能量暴露的外殼，以進行任何修理或維修，都十分危險。

- 請勿在爐門開啟的情況下使用微波爐，或以任何方式修改門鎖。
- 如在爐門密封襯墊和襯墊表層之間附有物件，請勿使用微波爐。

請勿讓油脂或塵埃在爐門密封襯墊及其相連部份積聚。請定時清潔本微波爐，並清除任何殘留食物。請參閱 C-15 頁的“保養及清潔”說明。如未有保持微波爐處清潔，可能會損害其表面，導致設備壽命縮短，並可能引起危險。

- 配有心臟起搏器的人士，請諮詢醫生或該器材的製造商，以了解有關使用微波爐的注意事項。

為避免可能導致觸電的情況

- 在任何情況之下，亦不應拆除外箱。
- 請勿跌入或插入任何物件於門鎖口或通風口。如有不慎跌入物件，請立即拔除電源，並聯絡 SHARP 客戶服務中心跟進。
- 請勿把電源線或插頭浸在水或任何其他液體中。
- 請勿讓電源線掛在桌子或檯面邊緣。



- 請保持電源線遠離熱燙表面，包括微波爐後。
- 請勿試圖自行更換爐燈，或讓任何不屬於SHARP授權之合格服務技術人員進行有關工作。如爐燈失效，請諮詢您的經銷商或SHARP授權維修代理。
- 如本設備的電源線受損，必須以客戶專用電線更換。
- 有關更換工作必須由SHARP 客戶服務中心進行。

為避免導致爆炸及爆沸的情況：

**警告：**液體及其他食物絕不可在密封容器內加熱，以免有爆炸的情況發生。

如加熱飲品，有可能導致延後爆沸，因此在處理有關容器時必須特別小心。

- 切勿使用密封容器。在使用前，必須先移除封條及蓋子。即使在微波爐關掉後，密封容器仍有可能因為壓力的累積而爆炸。
- 在微波加熱液體時，必須特別小心。請使用開口容器，讓氣泡可排走。

**切勿使用窄口容器加熱液體，如嬰兒奶瓶，因為在加熱時，容器內的液體可能會噴出導致燙傷。**

- 為免滾熱液體爆沸及可能導致燙傷：
  1. 請勿烹調過長時間。
  2. 在加熱/翻熱前攪拌液體。
  3. 在翻熱時，建議加入玻璃棒或類似工具（非金屬）。
  4. 在烹調完成後，讓液體靜止最少 20 秒，以防延後爆沸。

**請勿以微波爐烹調連殼生雞蛋，連殼熟雞蛋亦不應以微波爐加熱，因為它們有可能爆炸，即使在烹調完成後。如需烹調或翻熱未經炒煮或混合的雞蛋，請刺穿蛋黃及蛋白，否則雞蛋可能會爆炸。在以微波爐翻熱熟雞蛋前，請去殼並切片。**

- 在烹調薯仔、香腸及水果時，請刺穿其表皮，否則它們可能會爆炸。

為避免導致燙傷的情況：

**警告：**嬰兒奶瓶及食物樽內食物，在進食前必須攪拌或搖晃，並檢查其溫度，以避免燙傷。

- 從微波爐拿取食物時，請使用鍋墊或焗爐手套，以避免燙傷。

- 使用容器、爆谷食材、焗爐袋時，請必須打開，並遠離面孔及手部，以免被蒸汽及爆沸燙傷。

**為免燙傷，在食用前請時常測試食物溫度，並加以攪拌；如為嬰兒、兒童及老人提供食物，更要特別小心。可接觸的爐身部分在使用時可能會變得熱燙，請勿讓兒童接近。**

- 容器的溫度未必能真正代表食物或飲品的溫度，此每次都必須檢查食物或飲品的溫度。
- 每次打開爐門時，都要盡量遠離，以免有溢出的蒸氣和熱力燙傷。
- 在加熱填充烤焗食物後，請切片以釋放蒸氣並避免燙傷。
- 此設備不應使用外置計時器或遙控系統操作。
- 兒童請遠離門板，以免被燒傷。

為避免兒童誤用：

**警告：**請先為兒童提供充分指導，讓他們能夠安全使用本微波爐，並明白不當使用的危險後，方可讓兒童在沒有監督下使用。本設備並不是為身體、感官或心理有缺憾，或缺乏相關經驗或知識的人士(包括兒童)而設計，除非他們在能夠負責其安全的人監督，或已接受其操作指示的情況下使用。兒童應受到監管，以免他們玩弄此電器。

- 請勿靠倚在爐門上或將爐門來回搖晃。
- 請勿以本微波爐嬉戲或視之為玩具。
- 請教導兒童認識所有重要安全說明：使用鍋墊、小心移除食物蓋子，特別注意令食物鬆脆的包裝(如：發熱物料)，它們可能會特別熱燙。

其他警告：

- 切勿以任何方式改動微波爐。
- 當微波爐正在操作時，請勿移動。
- 此微波爐僅適用於家居環境，並僅可作烹調食物。不適合商業或實驗室用途。



## 重要安全須知

為安心使用本產品並避免損壞：

- 切勿在微波爐內空無一物時進行操作。當使用烤架或發熱材料時，請經常在它們下面放置耐熱隔層，如陶瓷碟，以免因熱壓而損壞轉盤及旋轉架。預熱時間切勿超過菜式的指示。
- 請勿使用金屬用具，它們會反射微波，可能會造成電弧現象。請勿把罐頭放進微波爐。
- 請使用專為本微波爐而設計的轉盤和旋轉架。請勿在沒有轉盤的情況下使用本微波爐。

為免轉盤破裂：

- 在以水清洗轉盤前，請讓轉盤冷卻。
- 請勿放置熱食物或用具在冷轉盤上。
- 請勿放置冷食物或用具在熱轉盤上。
  - 在微波爐操作時，請勿放置任何物件在外箱上。

**注意：**

- 如您不肯定如何連接您的微波爐，請諮詢合格電工。
- 如因未能瞭解正確的電力連接程序，而造成微波爐損壞或個人損傷，製造商及經銷商概不負責。
- 爐壁或爐門密封襯墊和襯墊表層上，間中可能有水氣或水點凝結。這些都屬正常現象，並不表示有微波洩漏或操作異常。



## 安裝事宜

- 從微波爐內部移除所有包裝物料。
- 仔細檢查微波爐是否有任何損壞跡象。
- 將微波爐放在穩固的平面上，該位置應可負荷爐身加上烹調最重食物時的總重量。請勿將微波爐放在廚櫃中。
- 選擇一個可提供足夠空間予進氣及/或散氣的平面。設備後方應面向牆壁。
  - 微波爐和鄰近牆壁之間的空間，最少有 20 厘米。
  - 在微波爐上方留下最少 30 厘米的空間。
  - 請勿除去微波爐底部的爐腳。
  - 如阻擋出及/或入的通風口，可能會損壞微波爐。
  - 請把微波爐放在遠離收音機和電視的位置，微波爐操作期間可能會影響電台或電視的接收。

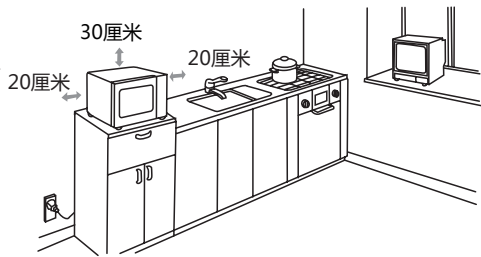

- 穩妥地連接微波爐的插頭到標準接地(有地線)家居電源插座。

**警告：**請勿把微波爐放置在會產生熱力、潮濕或高濕度的地方(例如:傳統焗爐附近或上面)或接近易燃物料(例如:布料傢俱)。請勿阻擋或阻塞散氣口。請勿在爐頂放置物品。



## 使用之前



將微波爐的插頭連接電源後，會顯示：“0:00”，並會響一次聲音訊號。本型號設有時鐘功能，在備用時候耗用少於 1.0 瓦。時鐘設定方式請參閱下頁。



## 設定時鐘



您的微波爐設有 24 小時時間模式。

1. 按一次**設定時鐘鍵** ，"00:00" 會閃動。
2. 按時間鍵，輸入當前時間。按 **10 分鐘** 鍵輸入小時，按 **1 分鐘** 及 **10 秒** 鍵輸入分鐘。
3. 按**設定時鐘鍵** ，以完成時鐘設定。

### 注意：

- 如時鐘已設定，當烹調完成，顯示屏會顯示當日正確時間。如果未設定時鐘，則僅會顯示 "0:00"。
- 如欲在烹調期間檢查時間，請按**設定時鐘** 鍵，LED 會顯示當日時間 2-3 秒。這不會影響烹調程序。
- 如在設定時鐘期間按**暫停/取消** 鍵，或在 1 分鐘內沒有操作，微波爐會回到之前的設定。
- 如微波爐的電源供應中斷，顯示屏會在電源恢復後間歇顯示 "0:00"。如果在烹調期間遇到此情況，有關程序將會被取消。已設定的時間亦會被刪除。

## 微波強度



微波強度	按微波強度鍵 	顯示 (百分比)
高	x1	100P
	x2	90P
中高	x3	80P
	x4	70P
中	x5	60P
	x6	50P
中低 (解凍)	x7	40P
	x8	30P
低	x9	20P
	x10	10P
	x11	0P

- 您的微波爐有 11 個微波強度，詳見列表。
- 如欲更改烹調強度，請按**微波強度** 鍵，直至顯示需要的強度，然後按時間鍵輸入所需烹調時間，再按**即時烹調/開始** 鍵即可啟動微波爐。
- 如欲在烹調期間檢查微波強度，可按**微波強度** 鍵。雖然顯示屏正顯示微波強度，微波爐仍會繼續運作。
- 如選擇 "0P"，微波爐會啟動風扇但沒有微波強度。您可以此設定來去除異味。

一般來說，可參考以下建議：

**100P/ 90P** - (高) 用於快速烹調，或翻熱食物，如砂鍋食物、熱飲及蔬菜等。

**80P/ 70P** - (中高) 可用於較長時間的烹調，如烤肉、肉卷及碟盤食物等，亦可用於對熱度較敏感的食物如海綿蛋糕。在此較低強度的設定下，食物的烹調會較均勻，不會令邊緣位置過熱。

**60P/ 50P** - (中) 可用於密度較高的食物，它們在傳統烹調時需要較長時間，如砂鍋牛肉。如欲確保肉質較嫩，建議使用此設定。

**40P/ 30P** - (中低) 可用於解凍，選擇此設定可確保食物解凍效果均勻。此設定亦適用於煮飯、意粉、餃子及蛋撻。

**20P/ 10P** - (低) 用於慢速解凍，如忌廉蛋糕或麵糰。



## 自選烹調操作

### 打開爐門：

按下開門按鍵，即可打開爐門。

### 啟動微波爐：

將食物放在合適的容器內，再放在轉盤上，或直接放在轉盤上。

關閉爐門，選擇需要的烹調模式，再按**即時烹調/開始**鍵。

當烹調程序已選定，但未有在一分鐘內按**即時烹調/開始**鍵，該設定會被取消。

如在烹調中途曾打開爐門，必須再按**即時烹調/開始**鍵才可繼續烹調。如按鍵有效，聲音訊號會響一次，如按鍵無效則不會有聲響。

### 使用暫停/取消鍵：

1. 在設定程序時清除錯誤。
2. 在烹調期間暫停微波爐。
3. 在烹調期間取消程序，按**暫停/取消**鍵兩次。
4. 設定或取消兒童鎖 (參閱 C-9 頁)。

START/+30S  
開始/+30S

STOP/ECO  
暫停/節能



## 微波烹調

您的微波爐可設定最多 99 分鐘 50 秒 (99.50)。

### 自選烹調/自選解凍功能

- 輸入烹調時間並使用由 100P 到 10P 的微波強度，來進行烹調或解凍 (請參閱 C-7 頁)。
- 如有可能，請在烹調期間攪拌或翻轉食物兩至三次。
- 在烹調後，請按建議蓋好食物並擺放一會。
- 在解凍後，以錫紙蓋好食物，並讓它擺放直至完全解凍。

### 例子：

如需烹調 2 分鐘 30 秒，微波強度為 70%。

1. 按**微波強度**鍵四次，設定強度為 70 P。
2. 按**1分**鍵兩次及**10秒**鍵三次，以輸入烹調時間。
3. 按**即時烹調/開始**鍵，即可啟動計時器。  
(顯示屏會按已設定的烹調/解凍時間倒數。)



70P

2:30

2:30

### 注意：

- 當微波爐啟動時，爐燈會亮起，轉盤亦會以順時針或逆時針方向轉動。
- 如在烹調/解凍期間打開爐門，以攪拌或翻轉食物，顯示屏上的烹調時間會自動暫停。在關上爐門和按**即時烹調/開始**鍵後，烹調/解凍時間就會繼續運作。
- 當烹調/解凍已完成，打開爐門或按**暫停/取消**鍵，如已設定時鐘，就會再顯示當前時間。
- 如您想在烹調期間查看微波強度，請按**微波強度**鍵。

### 重要：

- 在烹調/解凍後關上爐門。注意當爐門開啟時，爐燈會一直亮起，這是提醒您關上爐門的安全措施。
- 如您僅以 100P 強度烹調食物超出標準時間，微波能量會自動被調低，以防止發生過熱的情況 (微波強度會被調低)。

烹調模式	標準時間
微波 100P	30分鐘



## 1. 分段式烹調

這項功能讓您可以最多兩個不同步驟烹調，包括自選烹調時間和模式及/或計時解凍以及重量解凍功能。一經設定即毋須干預烹調程序，微波爐會自動進行下一步驟。在第一個步驟結束後會聽到響聲一次。如果其中一個步驟為解凍，請設定為第一個步驟。

**注意：**自動烹調功能不能設定為分段式烹調的一部份。

**舉例：**如果您想把食物解凍 5 分鐘，然後以 80P 微波強度烹調 7 分鐘，可按以下步驟設定：

1. 按計時解凍鍵一次，LED 顯示屏會出現dEF2。
2. 輸入烹調時間，按1分鐘鍵 5 次。
3. 輸入強度 (80P)，按微波強度鍵 3 次。
4. 輸入烹調時間，按 1分鐘鍵 7 次。
5. 按即時烹調/開始鍵一次開始烹調。

## 2. 自動分鐘功能

即時烹調/開始鍵讓您操作以下兩項功能：

### a. 直接開始

按即時烹調/開始鍵，即可以 100P 微波強度直接開始烹調。



### b. 延長烹調時間

您可於進行自選烹調、計時解凍和自動功能期間，延長烹調時間。只需於烹調期間按即時烹調/開始鍵，每按一下即延長30秒。於進行重量解凍期間，不能按即時烹調/開始延長操作。

**注意：**烹調時間可延長至最高 99 分鐘 50 秒。

## 3. 計時器功能：

當微波爐並沒有用於烹調時，您可使用其計時器作計時用途，例如在煮食爐焗雞蛋計時時或提醒您已烹調或解凍食物可放置的時間。

**舉例：**

要設定計時器為 5 分鐘。

1. 按計時器鍵一次。
2. 輸入所需時間，按1分鐘鍵 5 次。
3. 按即時烹調/開始鍵啟動計時器。
4. 檢查顯示屏。  
(顯示屏會倒數已設定的烹調/解凍時間。)



當計時器所設定的時間到達時，響聲會響起 5 次，LED 則會顯示當天時間。您可輸入任何時間，最長為 99 分鐘 50 秒。要在倒數期間取消計時器，只需按暫停/取消鍵一次。

**注意：**計時器功能在烹調期間不能使用。

## 4. 兒童鎖：

用於防止兒童在沒有看管下操作微波爐。

### a. 設定兒童鎖：

按暫停/取消鍵 3 秒，直至聽到一聲長響的嗶聲。顯示屏會顯示：



### b. 取消兒童鎖：

按暫停/取消鍵 3 秒，直至聽到一聲長響的嗶聲。

如果5分鐘以內沒有任何操作（無論是待機或烹調狀態），會發出2下嗶聲並進入兒童安全鎖，而按鍵不能操作，必須要打開及關閉爐門才能重新使用按鍵功能



## 翻熱指引

翻熱食物時，請按以下建議及指引，以確保食物在食用前完全熟透。

<b>碟盤食物</b>	請先移走家禽或肉類，並按以下指引另外翻熱。 把小件的食物置於碟子中間，較大和較厚的置於碟邊。以微波爐紙覆蓋，並以 50% 翻熱，中途攪拌或調換食物位置。 注意：請確保食物在食用前已完全熟透。	
<b>切片肉類</b>	以透氣微波爐紙覆蓋，並以 50% 翻熱。 最少調換食物位置一次以確保平均翻熱。 注意：請確保肉類在食用前已完全熟透。	
<b>家禽類</b>	把較厚的部分置於盤的外圍，以透氣微波爐紙覆蓋，並以 70% 翻熱，中途翻轉食物。 注意：請確保家禽肉類在食用前已完全熟透。	
<b>砂鍋類</b>	以透氣微波爐紙或合適的蓋覆蓋，並以 50% 翻熱。不時攪拌以確保平均翻熱。 注意：請確保食物在食用前已完全熟透。	

要達致最佳翻熱效果，請使用合適該種食物的微波強度，例如蔬菜可以 100% 翻熱，但干層麵由於不能攪拌，所以應以 50% 翻熱。

### 注意：

- 翻熱前請拿掉錫紙或金屬器皿。
- 翻熱時間會受食物形狀、深度、份量和溫度，以及容器大小、形狀和物料影響。

**⚠ 警告：**  
切勿以窄頸容器翻熱液體，以防液體從容器噴出及燙傷。

- 避免過熱和起火，當翻熱高糖份或脂肪的食物如肉批或聖誕布甸時，必須格外謹慎。
- 切勿用以加熱食油或脂肪作煎炸用途，以防導致過熱和起火。
- 罐裝薯仔不宜以微波爐翻熱。請參照罐上的製造商指示。

**⚠ 警告：**  
嬰兒奶樽及瓶裝嬰兒食物必須攪拌或搖勻，並在食用前檢查溫度以防燙傷。



以微波爐解凍食物是最快捷的方法。  
解凍過程簡單，但請遵照以下重要指示，以確保食物完全解凍。

<b>調換位置</b>	<p>放置於盤子外圍的食物會較放置於中央的食物較快解凍。因此在凍解過程中，食物必須調換位置最多 4 次。</p> <p>把靠在一起的食物從盤子的外圍移到中央，並重新調換重疊的部分。這將能確保食物的所有部分平均解凍。</p>
<b>分開</b>	<p>食物從凍箱取出時或會黏在一起。在解凍過程中必須盡快先把食物分開，例如煙肉或雞柳。</p>
<b>遮蓋</b>	<p>食物的個別部份在解凍過程中可能變暖。為防食物變暖並開始烹熟，這些部分可以用錫紙遮蓋以反射微波，例如雞全隻上的雞腿或雞翅膀。</p>
<b>擺放</b>	<p>給食物足夠時間擺放可確保食物充分解凍。當食物從微波爐取出時，解凍程序並未完成。食物必須再以適當時間擺放並保持包裹，以確保食物中心位置亦完全解凍。</p>
<b>翻轉</b>	<p>在解凍過程中，所有食物必須翻轉最少 3 至 4 次，這對確保完全解凍非常重要。</p>

**注意：**

- 解凍前就先移除所有包裝及包裝材料。
- 要解凍食物，請使用 30% 或 10% 微波強度。



## 計時解凍及重量解凍操作

### 1. 計時解凍

這項功能可快速解凍食物，並讓您根據食物種類選擇適合的解凍時間。按照以下例子詳細了解如何操作這項功能。時間可設定為 0:10 – 99:50。

**舉例：**要解凍食物 10 分鐘。

1. 選擇所需項目，按**計時解凍**鍵一次。
2. 輸入解凍時間，按**10分鐘**
3. 按**即時烹調/開始**鍵開始解凍。



#### 計時解凍模式的注意事項：

- 烹調完成後會聽到 5 次響聲，如果時鐘設定正確 LED 會顯示當天時間，如果未有設定時鐘則會在烹調完成後顯示「0:00」。
- 預設微波強度為 30P，不可調校。

### 2. 重量解凍

微波爐預設的時間及微波強度或令以下食物不易解凍，包括豬肉、牛肉和雞肉。可調校的重量從 0.1公斤至 2 公斤，每按一次為 0.1公斤。

按照以下例子詳細了解如何操作這項功能。

**舉例：**要使用重量解凍來解凍重 1.2 公斤的肉類關節。把肉塊置於焗盤或微波爐解凍架並置於轉盤上。

1. 選擇所需項目，按**重量解凍**鍵一次。
2. 輸入解凍重量，按**重量**鍵直至顯示所需重量。
3. 按**即時烹調/開始**鍵開始解凍。  
(顯示屏會倒數已設定的解凍時間。)



冷藏食物會由 -18°C 開始解凍。

#### 重量解凍請注意：

- 冷藏食物前，確保食物新鮮及質素。
- 食物重量須取數最近的 0.1 公斤，例如 0.65 公斤應取至 0.7 公斤。
- 如有需要，請以平坦的錫紙遮蓋肉類或家禽的細小部分，以防止這些部分在解凍過程中變暖。請確保錫紙不會觸碰爐壁。



## 自動食譜烹調功能操作

自動功能鍵會自動計算正確的烹調模式及烹調食物 (詳情請參閱 C-3 及 C-13 頁)。按照以下例子詳細了解如何操作這項功能。

**舉例：**烹調兩隻焗薯 (460 克)，使用自動功能鍵。

1. 選擇所需項目，按**焗薯**鍵一次。
2. 按**重量上/下**鍵或連續按**焗薯**鍵，以選擇所需的焗薯數量 (最高為3)。
3. 按**即時烹調/開始**鍵開始烹調。  
(顯示屏會倒數已設定的烹調時間。)



#### 注意：

- 輸入食物重量或數量，可按**重量上/下**鍵直至顯示所需重量/數量。僅輸入食物重量，不包括容器重量。
- 如食物重量輕於或重於 C-13 頁的自動功能重量/數量列表，請以自選操作烹調。



自動功能	重量/份量/容器	程序
爆谷	0.05 公斤、0.1 公斤	把爆谷連袋直接置於轉盤 (請參閱以下注意事項: 「微波烹調爆谷功能的重要事項」)
焗薯	1、2、3 (隻) 1 隻焗薯 = 約 0.23 公斤 (原本溫度 20°C)	請採用大小約 0.23 公斤的焗薯, 並在每個焗薯上刺出多個小洞, 再置於轉盤近邊緣位置。烹調途中需翻轉及調換位置。食用前先冷卻 3 至 5 分鐘。
薄餅	0.1公斤、0.2公斤、 0.4 公斤 (碟) (原本溫度5°C)	把薄餅放到碟上並置於轉盤中央, 不要覆蓋。
冷凍蔬菜 (例如:小椰菜、青 豆、豌豆、雜 菜、西蘭花)	0.15公斤、0.35公斤、 0.5 公斤(碗) (原本溫度- 18°C)	把蔬菜放於適當的容器。每 0.1公斤蔬菜加 1 湯匙清水, 覆蓋容器並置於轉盤。烹調中途及烹調後均需攪拌。
飲品 (120毫升/杯)	1、2、3 (杯) (原本溫度 5°C)	把杯置於轉盤並在加熱後攪拌。
碟盤晚餐	0.25公斤、0.35公斤、 0.5 公斤 (碟) (原本溫度5°C)	把全碟晚餐(例如:肉類、蔬菜、白飯和薯仔)置於轉盤中央, 並按 C-12 頁上的指示操作。於烹調後攪拌可助溫度更平均。

### 注意：

- 最終溫度會視乎原本溫度而有所不同。烹調後請檢查食物是否滾熱。如有需要可手動延長烹調時間。
- 利用自動烹調的效果會受不同因素影響, 例如食物的形狀和大小, 以及就烹調效果的個人口味。如果您認為預設的效果不理想, 請調整烹調時間以配合您的要求。

### 微波烹調爆谷功能的重要事項：

- 當選用 0.1公斤裝爆谷, 建議烹調前先把包裝袋的每個袋角以三角形向下摺。  
請參照右圖。



- 當爆谷袋膨脹後不能正常轉動時, 請按 **暫停/取消** 鍵一次並打開爐門、調整包裝袋位置以確保平均烹調。

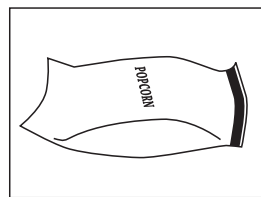



## 微波爐適用的器具

以微波爐烹調/解凍食物，必須讓微波能量穿過容器滲透到食物中，所以挑選適當的器皿是非常重要的。

圓形/橢圓形的碟盤比方形/長形較為合適，因為置於角落的食物會較易過熱。以下一系列均為適用的器皿。

器皿	微波安全	備註
錫紙 錫紙盤	✓ / ✗	小塊的錫紙可用以遮蓋食物防止過熱。保持錫紙離爐身最少 2 厘米，因錫紙可能產生電弧。 並不建議使用錫紙盤，除非製造商註明用法，例如 Microfoil ®，並請小心遵照指示使用。
燒烤盤	✓	必須遵照製造商指示。 請勿超過註明的加熱時間，並請非常小心。因為此類容器可能會非常燙熱。
瓷器及陶瓷	✓ / ✗	瓷器，陶器，釉面陶器和骨瓷器都通常適用，帶有金屬花紋除外。
玻璃器皿	✓	使用精巧的玻璃器皿須特別小心，如突然加熱可導致碎裂。
金屬	✗	不建議使用金屬器具，因可能產生電弧，並導致起火。
塑膠/聚苯乙烯 (例如快餐盒)	✓	必須小心使用，因部分此類容器會在高溫下變形、溶化或脫色。
保鮮紙	✓	不可接觸食物，並必須刺孔讓蒸汽排出。
冷藏/燒烤帶	✓	必須刺孔讓蒸汽排出，並請確保它們適合微波使用。
紙碟、紙杯、廚房紙	✓	請勿使用塑膠或金屬綁帶，因它們可能在金屬產生電弧時溶化或著火。
吸管及木製容器	✓	只可於加暖時使用或用以吸收水份。 必須小心使用，以防過熱著火。
再造紙及報紙	✗	使用這些物料時必須時刻留意微波爐，以防過熱著火。 可能含有金屬物質產生電弧並著火。

### △警告：

當以塑膠或紙類容器加熱食物時，請密切注意微波爐以防著火。





**小心：**請勿使用現成潔爐劑、蒸汽清潔機、磨砂清潔劑、過強的清潔劑、或任何含有氫氧化鈉或磨擦表層的潔具清潔微波爐的任何部分。定期清潔微波爐，並清除任何殘餘食物。確保微波爐清潔，否則微波爐表面可能損壞，並會縮短此電器的壽命，甚至導致危險情況。

#### 微波爐外部

微波爐的外部可輕易以溫和的梘液和清水清潔。請確保梘液以濕布抹淨，並以柔軟的毛巾抹乾微波爐外部。

#### 控制板

清潔前先打開爐門，以暫停控制板操作。清潔控制板必須格外小心。使用只有清水的濕布輕輕拭抹控制板直至潔淨。避免使用過量清水。切勿使用任何化學物或磨砂清潔劑。

#### 微波爐內部

1. 一般清潔，只需在每次用完當微波爐仍微暖時，以柔軟的濕布或海綿抹淨濺出的食物。如濺出的食物較多，使用溫和的梘液以濕布拭抹至清除所有食物殘渣。切勿拆出波導管罩。

2. 請確保梘液或清水沒有滲進爐壁的小孔，以免導致微波爐損壞。

3. 切勿使用噴霧式清潔劑清潔微波爐內部。永遠保持波導管罩清潔。

波導管罩是以容易損壞的物料製造，必須小心清潔（請遵照以上清潔指引）。

**注意：**過份浸透或會導致波導管罩分解。波導管罩屬消耗部件，如缺乏定期清潔或需更換。

#### 轉盤及轉盤旋轉架

把轉盤及轉盤旋轉架從微波爐拆出。

以溫和的清潔液加水清洗轉盤及轉盤旋轉架。轉盤及轉盤旋轉架均可使用洗碗碟機清洗。

#### 爐門

要清除所有污垢，請定期以柔軟的濕布清潔爐門兩面、爐門封邊及附近部分。切勿使用磨砂清潔劑。

**注意：**請勿使用蒸汽清潔機。

#### 清潔小秘訣 – 想更輕易清潔微波爐：

把半個檸檬放進碗內，加入 300 毫升 (1/2 品脫) 清水，並以 100% 加熱 10 至 12 分鐘。使用柔軟的乾布抹淨微波爐。



## 問題解決

確保電源線遠離受熱表面。如懷疑微波爐並非運作正常，在聯絡技術人員前您可先自行進行數項簡單檢查。

按以下步驟進行簡單檢查：把半杯水置於轉盤並關上爐門。使用 100% 微波強度設定微波爐烹調 1 分鐘。

1. 烹調期間爐內照明燈是否亮起？
2. 轉盤有否轉動？
3. 散熱風扇是否運作？（請把手放於通風口上檢查。）
4. 在 1 分鐘後有否聽到響聲？
5. 杯中的水是否熱燙？
6. 在 3 分鐘後燒烤熱管有否變紅？

如果就以上任何問題您的答案是「否」，請先檢查微波爐是否正確插上電源並且保險絲正常運作。如果兩者皆沒有問題，請查看以下問題解決列表。

**警告：切勿自行調校、修理或改裝微波爐。除接受過SHARP授權之合格服務技術人員以外，任何人等進行服務提供或維修均屬非常危險。這是非常重要的，因為過程可能涉及移除防止微波能量外洩的保護蓋。**

- 爐門封邊可在微波爐操作期間防止微波外洩，但並非密封式封存。如在爐門發現水滴、光線或微暖均屬正常現象。水份較高的食物會釋放蒸汽並在爐門內導致凝聚，因而從微波爐滴下水點。
- **維修及改裝：**當微波爐不能正常運作，請勿試圖進行操作。
- **外爐身及照明燈開蓋：**切勿拆開爐外箱。這將非常危險，因為會觸及爐內絕對不能觸及的高壓部分，嚴重者可致命。您的微波爐並不具備照明燈開蓋設計。如果照明燈損壞，切勿試圖自行更換，而應聯絡SHARP客戶服務中心。

### 問題解決列表

疑問	答案
空氣圍繞爐門流動。	微波爐在操作時，空氣會在內部流通。由於爐門並非密封式設計，所以空氣或會從爐門漏出。
爐內有水份凝聚，並可能從爐門滴下。	微波爐內部溫度一般會比正烹調的食物較低，所以在烹調過程中可能會出現蒸汽，並在較冷的表面凝聚。蒸汽的份量視乎正烹調的食物水份含量而定。個別食物如薯仔水份含量會較高。積聚在爐門玻璃的凝聚水份在數小時後應會散去。
烹調期間爐內出現閃光或產生電弧。	在烹調期間，當金屬物體離爐壁太近，將可能出現電弧的情況。這或會刮到爐壁，但不會損壞微波爐。
薯仔產生電弧	請確保薯仔上的所有薯眼均已切掉，並且在薯仔上刺洞。把薯仔直接置於轉盤或耐熱容器。
顯示屏亮起但控制面板按鍵沒有反應。	檢查爐門是否正常關閉。
微波爐烹調太慢。	確定選用正確微波強度。
微波爐發出噪音。	在烹調/解凍期間，微波能量會間歇脈動。
外爐身變熱。	觸碰外爐身有機會感覺燙熱，請勿讓兒童靠近。





# SHARP

Important



## R-230 S(B) / R-330 S(B) 800 W / 900 W

### MICROWAVE OVEN OPERATION MANUAL

ENGLISH

This operation manual contains important information which you should read carefully before using your microwave oven.

**IMPORTANT:** There may be a serious risk to health if this operation manual is not followed or if the oven is modified so that it operates with the door open.





**Operation manual**

CONTENTS ..... 1  
 SPECIFICATIONS ..... 1  
 OVEN AND ACCESSORIES ..... 2  
 CONTROL PANEL ..... 3  
 IMPORTANT SAFETY INSTRUCTIONS ..... 4-6  
 INSTALLATION ..... 6  
 BEFORE OPERATION ..... 6  
 SETTING THE CLOCK ..... 7  
 MICROWAVE POWER LEVEL ..... 7  
 MANUAL OPERATION ..... 8  
 MICROWAVE COOKING ..... 8  
 OTHER CONVENIENT FUNCTIONS ..... 9  
 REHEATING GUIDE ..... 10  
 DEFROSTING GUIDE ..... 11  
 TIME DEFROST AND WEIGHT DEFROST OPERATION ..... 12  
 AUTO MENU OPERATION ..... 12  
 AUTO MENU CHART ..... 13  
 SUITABLE OVENWARE ..... 14  
 CARE AND CLEANING ..... 15  
 TROUBLESHOOTING ..... 16



Model name:	R-230S(B)	R-330S(B)
AC Line Voltage	: 220V, 50 Hz	: 220V, 50 Hz
AC Power required: Microwave	: 1270 W	: 1450 W
Output power: Microwave	: 800 W	: 900 W
Off Mode (Energy Save Mode)	: less than 1.0 W	: less than 1.0 W
Microwave Frequency	: 2450 MHz*	: 2450 MHz*
Outside Dimensions (W) x (H) x (D) mm	: 440 x 259 x 324	: 513 x 307 x 394
Cavity Dimensions (W) x (H) x (D)** mm	: 306 x 206 x 304	: 368 x 206 x 328
Oven Capacity	: 20 litres**	: 25 litres**
Turntable	: ø 255 mm	: ø 315 mm
Weight	: approx. 11 kg	: approx. 14.5 kg

- \* This Product fulfils the requirement of the European standard EN55011. In conformity with this standard, this product is classified as group 2 class B equipment. Group 2 means that the equipment intentionally generates radio-frequency energy in the form of electromagnetic radiation for the heat treatment of food. Class B equipment means that the equipment is suitable to be used in domestic establishments.
- \*\* Internal capacity is calculated by measuring maximum width, depth and height. Actual capacity for holding food is less.

DESIGN AND SPECIFICATIONS ARE SUBJECT TO CHANGE WITHOUT PRIOR NOTICE



## OVEN AND ACCESSORIES

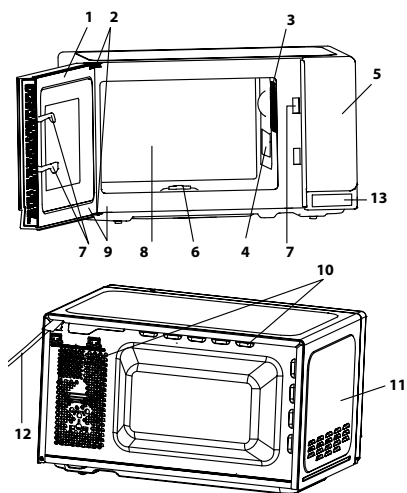

### OVEN

1. Door
2. Door hinges
3. Oven lamp
4. Waveguide cover (DO NOT REMOVE)
5. Control panel
6. Turntable motor shaft
7. Door Safety latches
8. Oven cavity
9. Door seals and sealing surfaces
10. Ventilation openings
11. Outer cabinet
12. Power supply cord
13. Door opening button

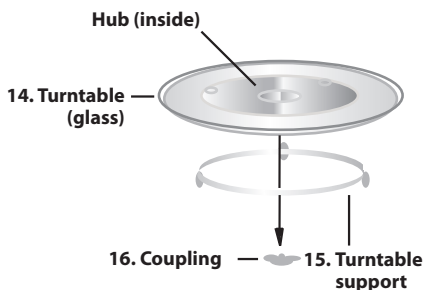

### ACCESSORIES:

Check to make sure the following accessories are provided:

(14) Turntable (15) Turntable support (16) Coupling  
Place the turntable support in the centre of the oven floor so that it can freely rotate around the coupling. Then place the turntable on to the turntable support so that it locates firmly into the coupling.

To avoid turntable damage, ensure dishes and containers are lifted clear of the turntable rim when removing them from the oven.

**NOTE:** When you order accessories, please mention two items: part name and model name to your dealer or SHARP authorised service agent.

### NOTES:

- The waveguide cover is fragile. Care should be taken when cleaning inside the oven to ensure that it is not damaged.
- Always operate the oven with the turntable and turntable support fitted correctly. This promotes thorough, even cooking. A badly fitted turntable may rattle, may not rotate properly and could cause damage to the oven.
- All food and containers of food are always placed on the turntable for cooking.
- The turntable rotates clockwise or anti-clockwise. The rotary direction may change each time you start the oven. This does not affect cooking performance.



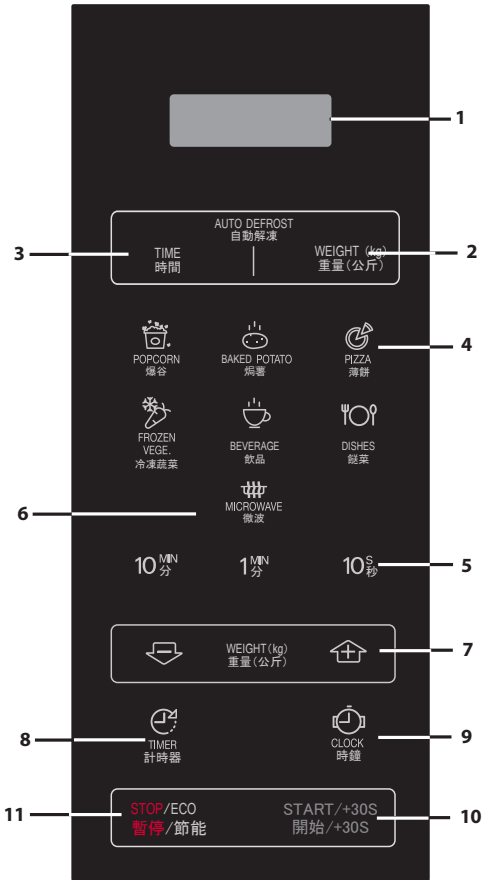

1. **DIGITAL DISPLAY**
2. **WEIGHT DEFROST button**
3. **TIME DEFROST button**
4. **AUTO MENU button**

 Popcorn

 Baked Potato

 Pizza

 Frozen Vegetables

 Beverage

 Dishes

5. **TIME button**  
Press to enter time, and keep pressing to continuously increase time.
6. **POWER LEVEL button:**  
Press to select microwave power level.
7. **WEIGHT button (up and down)**  
Press to increase/decrease weight, and keep pressing to continuously increase/decrease weight.
8. **TIMER button**  
Press to use as a minute timer, or to programme standing time.
9. **SET CLOCK button**
10. **INSTANT COOK/START button**
11. **STOP/CLEAR button**



## IMPORTANT SAFETY INSTRUCTIONS

### IMPORTANT SAFETY INSTRUCTIONS: READ CAREFULLY AND KEEP FOR FUTURE REFERENCE

#### To avoid the risk of fire.

**The microwave oven should not be left unattended during operation. Power levels that are too high, or cooking times that are too long, may overheat foods resulting in a fire.**

- This oven is designed to be used on a countertop only. It is not designed to be built into a kitchen unit. Do not place the oven in a cabinet.
- The electrical outlet must be readily accessible so that the unit can be unplugged easily in an emergency. The AC power supply must be 220V, 50Hz, with a minimum 10A distribution line fuse, or a minimum 10A distribution circuit breaker.
- A separate circuit serving only this appliance should be provided.
- Do not place the oven in areas where heat is generated. For example, close to a conventional oven.
- Do not install the oven in an area of high humidity or where moisture may collect.
- Do not store or use the oven outdoors.

**If smoke is observed, switch off or unplug the oven and keep the door closed in order to stifle any flames.**

**Use only microwave-safe containers and utensils. See Page E-14. Utensils should be checked to ensure that they are suitable for use in microwave ovens.**

**When heating food in plastic or paper containers, keep an eye on the oven for signs of smoke or burning.**

**Clean the waveguide cover, the oven cavity, the turntable and roller stay after use. These must be dry and free from grease. Built-up grease may overheat and begin to smoke or catch fire.**

- Do not place flammable materials near the oven or ventilation openings.
- Do not block the ventilation openings.
- Remove all metallic seals, wire twists, etc., from food and food packages. Arcing on metallic surfaces may cause a fire.
- Do not use the microwave oven to heat oil for deep frying. The temperature cannot be controlled and the oil may catch fire.
- To make popcorn, use only special microwave popcorn makers.
- Do not store food or any other items inside the oven.
- Check the settings after you start the oven to ensure the oven is operating as desired.
- To avoid overheating and fire, special care must be taken when cooking or reheating foods with a high sugar or fat content, for example, Sausage rolls, Pies or Christmas pudding.

#### To avoid the risk of injury

##### WARNING:

Do not operate the oven if it is damaged or malfunctioning. Check the following before use:

- a) The door; make sure the door closes properly and ensure it is not misaligned or warped.
- b) The hinges and safety door latches; check to make sure they are not broken or loosened.
- c) The door seals and sealing surfaces; ensure that they have not been damaged.
- d) Inside the oven cavity or on the door; make sure there are no dents.
- e) The power supply cord and plug; ensure that they are not damaged.

If the door or door seals are damaged, the oven must not be operated until it has been repaired by a qualified service technician trained by SHARP.

**Never adjust, repair or modify the oven yourself. It is hazardous for anyone other than a qualified service technician trained by SHARP to carry out any service or repair operation which involves the removal of a cover which gives protection against exposure to microwave energy.**

- Do not operate the oven with the door open or alter the door safety latches in any way.
- Do not operate the oven if there is an object between the door seals and sealing surfaces.

**Do not allow grease or dirt to build up on the door seals and adjacent parts. Clean the oven at regular intervals and remove any food deposits. Follow the instructions for "Care and Cleaning" on page E-15. Failure to maintain the oven in a clean condition could lead to a deterioration of the surface that could adversely affect the life of the appliance and possibly result in a hazardous situation.**

- Individuals with PACEMAKERS should check with their doctor or the manufacturer of the pacemaker for precautions regarding microwave ovens.

##### To avoid the risk of electric shock

- Do not remove the outer cabinet.
- Never spill or insert any objects into the door lock openings or ventilation openings. In the event of a spill, turn off and unplug the oven immediately, and call an authorised SHARP service agent.
- Do not immerse the power supply cord or plug in water or any other liquid.
- Do not let the power supply cord hang over the edge of a table or work surface.

## IMPORTANT SAFETY INSTRUCTIONS



- Keep the power supply cord away from heated surfaces, including the rear of the oven.
- Do not attempt to replace the oven lamp yourself or allow anyone who is not an electrician authorised by SHARP to do so. If the oven lamp fails, please consult your dealer or an authorised SHARP service agent.
- If the power supply cord of this appliance is damaged, it must be replaced with a special cord.
- The exchange must be made by an authorised SHARP service agent.
- Always open containers, popcorn makers, oven cooking bags, etc., away from the face and hands to avoid steam burns and eruption of boiling.

**To avoid burns, always test food temperature and stir before serving and pay special attention to the temperature of food and drink given to babies, children or the elderly. Accessible parts may become hot during use. Young children should be kept away.**

### To avoid the risk of explosion and sudden boiling:

**WARNING: Liquids and other foods must not be heated in sealed containers to avoid the risk of explosion.**

**Microwave heating of beverages can result in delayed eruptive boiling, therefore care must be taken when handling the container.**

- Never use sealed containers. Remove seals and lids before use. Sealed containers can explode due to a build up of pressure even after the oven has been turned off.
- Pay attention when microwaving liquids. Use a wide mouthed container to allow bubbles to escape.

**Never heat liquids in narrow necked containers such as baby bottles, as this may result in eruption of the contents from the container when heated and cause burns.**

- To prevent sudden eruption of boiling liquid and possible scalding:
  1. Do not use excessive cooking time.
  2. Stir liquid prior to heating/reheating.
  3. Insert a glass rod or similar utensil (not metal) into the liquid whilst reheating.
  4. Let the liquid stand for at least 20 seconds in the oven at the end of cooking time to prevent delayed eruptive boiling.

**Do not cook eggs in their shells and whole hard boiled eggs should not be heated in microwave ovens since they may explode even after microwave cooking has ended. To cook or reheat eggs which have not been scrambled or mixed, pierce the yolks and the whites, or the eggs may explode. Shell and slice hard boiled eggs before reheating them in the microwave oven.**

- Pierce the skin of foods such as potatoes, sausages and fruit before cooking, or they may explode.

### To avoid the risk of burns

**WARNING: The contents of feeding bottles and baby food jars must be stirred or shaken and the temperature checked before consumption, in order to avoid burns.**

- Use pot holders or oven gloves when removing food from the oven to prevent burns.

- The temperature of the container is not always a true indication of the temperature of the food or drink; always check the food or drink temperature.
- Always stand back from the oven door when opening it to avoid burns from escaping steam and heat.
- Slice stuffed baked foods after heating to release steam and avoid burns.
- Keep children away from the door to prevent them from burning themselves.
- External timer or remote control system operation can't be applied in this unit.

### To avoid misuse by children

**WARNING: Only allow children to use the oven without supervision when adequate instructions have been given so that the child is able to use the oven in a safe way and understands the hazards of improper use. This appliance is not intended for use by persons (including children) with reduced physical, sensory or mental capabilities, or lack of experience and knowledge, unless they have been given supervision or instruction concerning use of the appliance by a person responsible for their safety. Children should be supervised to ensure that they do not play with the appliance.**

- Do not lean or swing on the oven door.
- Do not play with the oven or use it as a toy.
- Children should be taught all important safety instructions: use of pot holders, careful removal of food coverings; paying special attention to packaging (e.g. self-heating materials) designed to make food crisp, as they may be extra hot.

### Other warnings

- Never modify the oven in any way.
- Do not move the oven while it is in operation.
- This oven is for home food preparation only and may only be used for cooking food. It is not suitable for commercial or laboratory use.



## IMPORTANT SAFETY INSTRUCTIONS

### To ensure trouble-free use of your oven and avoid damage.

- Never operate the oven when it is empty. When using a browning dish or self-heating material, always place a heat-resistant insulator such as a porcelain plate under it to prevent damage to the turntable and turntable support due to heat stress. The preheating time specified in the dishes instructions must not be exceeded.
- Do not use metal utensils, which reflect microwaves and may cause electrical arcing. Do not put cans in the oven.
- Use only the turntable and the turntable support designed for this oven. Do not operate the oven without the turntable.

### To prevent the turntable from breaking:

- (a) Before cleaning the turntable with water, leave the turntable to cool.

- (b) Do not put hot foods or hot utensils on a cold turntable.
- (c) Do not put cold foods or cold utensils on a hot turntable.

• Do not place anything on the outer cabinet during operation.

### NOTE:

- If you are unsure how to connect your oven, please consult an authorised, qualified electrician.
- Neither the manufacturer nor the dealer can accept any liability for damage to the oven or personal injury resulting from failure to observe the correct electrical connection procedure.
- Water vapour or drops may occasionally form on the oven walls or around the door seals and sealing surfaces. This is a normal occurrence and is not an indication of microwave leakage or a malfunction.



## INSTALLATION

1. Remove all packing materials from the inside of the oven cavity.
2. Check the oven carefully for any signs of damage.
3. Place oven on a secure, level surface, strong enough to take the oven weight, plus the heaviest item likely to be cooked in the oven. Do not place the oven in a cabinet.
4. Select a level surface that provides enough open space for the intake and/or outlet vents. The rear surface of appliance shall be placed against a wall.

- A minimum space of 20 cm is required between the oven and any adjacent walls.
- Leave a minimum space of 30 cm above the oven.
- Do not remove the feet from the bottom of the oven.
- Blocking the intake and/or outlet openings can damage the oven.
- Place the oven as far away from radios and TV's as possible. Operation of the microwave oven may cause interference to your radio or TV reception.

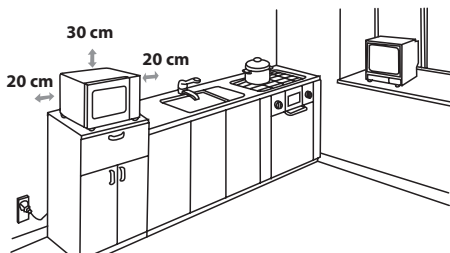

5. Securely connect the plug of the oven to a standard earthed (grounded) household electrical outlet.

**WARNING:** Do not place the oven where heat, moisture or high humidity are generated, (for example, near or above a conventional oven) or near combustible materials (for example, soft furnishings). Do not block or obstruct air vent openings. Do not place objects on top of the oven.



## BEFORE OPERATION

Plug in the oven. The oven display will display: "0:00", an audible signal will sound once.



This model has a clock function and the oven uses less than 1.0 W in stand by mode.

**To set the clock, see next page.**

## SETTING THE CLOCK



Your oven has a 24 hour clock mode.

1. Press the **CLOCK** button  once and "00:00" will flash.
2. Press the time keys and enter the current time. Enter the hours by pressing the **10 min.** button and enter the minutes by pressing the **1 min.** and **10 sec.** button.
3. Press the **CLOCK** button  to finish clock setting.

### NOTES:

- If the clock is set, when cooking is complete, the display will show the correct time of day. If the clock has not been set, the display will only show "0:00" when cooking is complete.
- To check the time of day during a cooking process, press **CLOCK** button and the LED will display the time of day for 2-3 seconds. This does not affect the cooking process.
- In the process of clock setting, if the **STOP/CLEAR** button is pressed or if there is no operation within 1 minute, the oven will go back to the former setting.
- If the electrical power supply to your microwave oven is interrupted, the display will intermittently show "0:00" - after the power is reinstated. If this occurs during cooking, the programme will be erased. The time of day will also be erased.

## MICROWAVE POWER LEVEL



Power Level	Press the <b>POWER LEVEL</b> button 	Display (Percentage)
HIGH	x1	100P
	x2	90P
MEDIUM HIGH	x3	80P
	x4	70P
MEDIUM	x5	60P
	x6	50P
MEDIUM LOW (DEFROST)	x7	40P
	x8	30P
LOW	x9	20P
	x10	10P
	x11	0P

- Your oven has 11 power levels, as shown.
- To change the power level for cooking, press the **POWER LEVEL** button until the display indicates the desired level. Enter the cooking time and press the **START** button to start the oven.
- To check the power level during cooking, press the **POWER LEVEL** button. The oven continues to count down although the display will show the power level.
- If "0P" is selected, the oven will work with the fan but no power. You can use this level to remove the odour.

Generally the following recommendations apply:

**100P/ 90P** - (HIGH) used for fast cooking or reheating e.g. for casseroles, hot beverages, vegetables etc.

**80P/ 70P** - (MEDIUM HIGH) used for longer cooking of dense foods such as roast joints, meat loaf and plated meals, also for sensitive dishes such as sponge cakes. At this reduced setting, the food will cook evenly without over cooking at the sides.

**60P/ 50P** - (MEDIUM) for dense foods which require a long cooking time when cooked conventionally, e.g. beef casserole, it is advisable to use this power setting to ensure the meat will be tender.

**40P/ 30P** - (MEDIUM LOW) to defrost, select this power setting, to ensure that the dish defrosts evenly. This setting is also ideal for simmering rice, pasta, dumplings and cooking egg custard.

**20P/ 10P** - (LOW) For gentle defrosting, e.g. cream gateaux or pastry.



## MANUAL OPERATION

### Opening the door:

To open the oven door, push the door opening button.

### Starting the oven:

Prepare and place food in a suitable container onto the turntable or place directly onto the turntable. Close the door and press the **INSTANT COOK/START** button after selecting the desired cooking mode.

Once the cooking programme has been set and the **INSTANT COOK/START** button is not pressed in 1 minute, the setting will be cancelled.

The **INSTANT COOK/START** button must be pressed to continue cooking after the door is opened during cooking. The audible signal sounds once by efficient press, inefficient press will be no response.

Use the **STOP/CLEAR** button to:

1. Erase a mistake during programming.
2. Stop the oven temporarily during cooking.
3. Cancel a programme during cooking, press the **STOP/CLEAR** button twice.
4. To set and to cancel the child lock (refer to page E-9).

START/+30S  
開始/+30S

STOP/ECO  
暫停/節能



## MICROWAVE COOKING

Your oven can be programmed for up 99 minutes 50 seconds (99.50).

### MANUAL COOKING/ MANUAL DEFROSTING

- Enter the cooking time and use microwave power levels 100P to 10P to cook or defrost (refer to page E-7).
- Stir or turn the food, where possible, 2 - 3 times during cooking.
- After cooking, cover the food and leave to stand, where recommended.
- After defrosting, cover the food in foil and leave to stand until thoroughly defrosted.

### Example:

To cook 2 minutes and 30 seconds on 70% microwave power.

1. Input the power level by pressing the **POWER LEVEL** button 4 times for 70 P.
2. Enter the cooking time by pressing the **1 min.** button twice and then the **10 sec.** button 3 times.
3. Press the **INSTANT COOK/START** button to start the timer. (The display will count down through the set cooking/defrosting time.)



70P

2:30

2:30

### NOTE:

- When the oven starts, the oven lamp will light and the turntable will rotate clockwise or anticlockwise.
- If the door is opened during cooking/defrosting to stir or to turn over food, the cooking time on the display stops automatically. The cooking/ defrosting time starts to count down again when the door is closed and the **INSTANT COOK/START** button is pressed.
- When cooking/defrosting is complete, open the door or press **STOP/CLEAR** button and the time of day will reappear on the display, if the clock has been set.
- If you wish to know the power level during cooking, press the **POWER LEVEL** button.

### IMPORTANT:

- Close the door after cooking / defrosting. Please note that the light will remain on when the door is open, this is for safety reasons to remind you to close the door.
- If you cook the food over the standard time with only 100P, the power of the oven will lower automatically to avoid overheating. (The microwave power level will be reduced).

Cooking Mode	Standard time
Microwave 100P	30 minutes

## OTHER CONVENIENT FUNCTIONS



### 1. SEQUENCE COOKING

This function allows you to cook using up to 2 different stages which can include manual cooking time and mode and /or time defrost as well as weight defrost function. Once programmed there is no need to interfere with the cooking operation as the oven will automatically move onto the next stage. The audible signal will sound once after the first stage. If one stage is defrosting, it should be in the first stage.

**Note:** Auto menu cannot be set as one of the multiple sequences.

**Example: If you want to defrost the food for 5 minutes, then to cook with 80P microwave power for 7 minutes. The steps are as follows:**

1. Press the **AUTO DEFROST-TIME** button once, in the LED display will appear dEF2.
2. Enter the cooking time by pressing the **1 min.** button 5 times.
3. Input the power level (80P) by pressing the **POWER LEVEL** button 3 times.
4. Enter the cooking time by pressing the **1 min.** button 7 times.
5. Press the **INSTANT COOK/START** button once to start cooking.

### 2. AUTO MINUTE FUNCTION

The **INSTANT COOK/START** button allows you to operate the two following functions:

#### a. Direct start

You can directly start cooking on 100P microwave power level by pressing the **AUTO MINUTE** button.



#### b. Extend the cooking time

You can extend the cooking time during manual cooking, time defrost and auto menu operation in multiples of 30 seconds if the **INSTANT COOK/START** button is pressed while the oven is in operation. During the weight defrost, the cooking time cannot be increased by pressing **INSTANT COOK/START** button.

**NOTE:** The cooking time may be extended to a maximum of 99 minutes 50 seconds.

### 3. TIMER FUNCTION :

You can use the timer for timing where microwave cooking is not involved for example to time boiled eggs cooked on conventional hob or to monitor the standing time for cooked/defrosted food.

#### Example:

To set the timer for 5 minutes.

1. Press the **TIMER** button once.
2. Enter the desired time by pressing the **1 min.** button 5 times.
3. Press the **INSTANT COOK/START** button to start the timer
4. **Check the display.** (The display will count down through the set **cooking/defrosting** time.)



When the timer time arrives, the audible signal will sound 5 times and the LED will display the time of day. You can enter any time up to 99 minutes 50 seconds. To cancel the **TIMER** whilst counting down, simply press the **STOP/CLEAR** button.

**NOTE:** The **TIMER** function cannot be used whilst cooking.

### 4. CHILD LOCK:

Use to prevent unsupervised operation of the oven by children.

#### a. To set the CHILD LOCK:

Press and hold the **STOP/CLEAR** button for 3 seconds until a long beep sounds. The display will show:



#### b. To cancel the CHILD LOCK:





Press and hold the **STOP/CLEAR** button for 3 seconds until a long beep sound.

If there is no operation within 5 minutes (whether it in standby or cooking mode), the child safety lock will be started by 2 beep sounds, and the button cannot be operated. The door must be opened and closed to restart the button function.



## REHEATING GUIDE

For the reheating of foods, follow the advice and guidelines below to ensure food is thoroughly reheated before serving.

<b>Plated meals</b>	<p><b>Remove any poultry or meat portions, reheat these separately, see below.</b></p> <p>Place smaller items of food to the centre of the plate, larger and thicker foods to the edge. Cover with vented microwave cling film and reheat on 50%, stir/rearrange halfway through reheating.</p> <p><b>NOTE:</b> Ensure the food is thoroughly reheated before serving.</p>	
<b>Sliced meat</b>	<p>Cover with vented microwave cling film and reheat on 50%. Rearrange at least once to ensure even reheating.</p> <p><b>NOTE:</b> Ensure the meat is thoroughly reheated before serving.</p>	
<b>Poultry portions</b>	<p>Place thickest parts of the portions to the outside of the dish, cover with vented microwave cling film and reheat on 70%. Turn over halfway through reheating.</p> <p><b>NOTE:</b> Ensure the poultry is thoroughly reheated before serving.</p>	
<b>Casseroles</b>	<p>Cover with vented microwave cling film or a suitable lid and reheat on 50%. Stir frequently to ensure even reheating.</p> <p><b>NOTE:</b> Ensure the food is thoroughly reheated before serving.</p>	

To achieve the best results when reheating, select a suitable microwave power level appropriate to the type of food. e.g. A bowl of vegetables can be reheated using 100%, while a lasagne which contains ingredients that cannot be stirred, should be reheated using 50%.

### NOTES:

- Remove food from foil or metal containers before reheating.
- Reheating times will be affected by the shape, depth, quantity and temperature of food together with the size, shape and material of the container.



#### **WARNING:**

**Never heat liquids in narrow-necked containers, as this could result in the contents erupting from the container and may cause burns.**

- To avoid overheating and fire, special care must be taken when reheating foods with a high sugar or fat content, e.g. mince pies or Christmas pudding.
- Never heat oil or fat for deep frying as this may lead to overheating and fire.
- Canned potatoes should not be heated in the microwave oven, follow the manufacturer's instructions on the can.



#### **WARNING:**

**The contents of feeding bottles and baby food jars are to be stirred or shaken and the temperature is to be checked before consumption to avoid burns.**





Defrosting food using your microwave oven is the quickest method of all. It is a simple process but the following instructions are essential to ensure the food is thoroughly defrosted.

<b>Rearrange</b>	Foods that are placed towards the outside of the dish will defrost quicker than foods in the centre. It is therefore essential that the food is rearranged up to 4 times during defrosting. Move closely packed pieces from the outside to the centre and rearrange over-lapping areas. This will ensure that all parts of the food defrosts evenly.
<b>Separate</b>	Foods may be stuck together when removed from the freezer. It is important to separate foods as soon as possible during defrosting, e.g. bacon rashers, chicken fillets.
<b>Shield</b>	Some areas of food being defrosted may become warm. To prevent them becoming warmer and starting to cook, these areas can be shielded with small pieces of foil, which reflect microwaves, e.g. legs and wings on a chicken.
<b>Stand</b>	Standing time is necessary to ensure food is thoroughly defrosted. Defrosting is not complete once the food is removed from the microwave oven. Food must stand, covered, for a length of time to ensure the centre has completely defrosted.
<b>Turn over</b>	It is essential that all foods are turned over at least 3 - 4 times during defrosting. This is important to ensure thorough defrosting.

**NOTES:**

- Remove all packaging and wrapping before defrosting.
- To defrost food, use microwave power levels 30% or 10%.



## TIME DEFROST AND WEIGHT DEFROST OPERATION

### 1. TIME DEFROST

This function quickly defrosts food while enabling you to choose a suitable defrost period, depending on the food type. Follow the example below for details on how to operate this function. The time range is 0:10 – 99:50.

**Example:** To defrost the food for 10 minutes.

1. Select the menu required by pressing the **TIME DEFROST** button once.
2. Enter the cooking time by pressing the **10 min.** button once.
3. Press the **INSTANT COOK/START** button to start cooking.



x1, the display will show:



#### Notes for Time Defrost:

- After cooking the audible signal will sound five times and the LED will display the time of day, if the clock has been set. If the clock has not been set, the display will only show "00:00" when cooking is complete.
- The preset microwave power level is 30P and can not be changed.

### 2. WEIGHT DEFROST

The microwave oven is pre-programmed with a time and power level so that the following food is defrosted easily: Pork, beef and chicken. The weight range for this food is from 0.1kg – 2kg in 0.1kg steps. Follow the example below for details on how to operate these functions.

**Example :** To defrost a meat joint weighing 1.2kg using WEIGHT DEFROST.

Place the meat in a flan dish or microwave oven defrost rack on the turntable.

1. Select the menu required by pressing the **WEIGHT DEFROST** button once.
2. Enter the weight by pressing the **WEIGHT** button until the desired weight is displayed.
3. Press the **INSTANT COOK/START** button to start cooking. (The display will count down through defrosting time)



x1, the display will show:



, display:

Frozen foods are defrosted from -18°C.

#### NOTES FOR WEIGHT DEFROST:

- Before freezing foods, ensure food is fresh and of good quality.
- Food weight should be rounded up to the nearest 0.1kg, for example, 0.65kg to 0.7kg.
- If necessary, shield small areas of meat or poultry with flat pieces of aluminium foil. This will prevent areas from becoming warm during defrosting. Ensure the foil does not touch the oven walls.



## AUTO MENU OPERATION

The **AUTO MENU** button automatically work out the correct cooking mode and cooking of the foods (details on page E-3 and E-13). Follow the example below for details on how to operate this function.

**Example:** To cook two jacket potatoes (460g) by using the AUTO MENU function.

1. Select the required menu by pressing the **Baked Potato** button once.
2. Press **WEIGHT UP/DOWN** button or continue to press the **Baked Potato** button to choose the required number of potatoes (up to 3).
3. Press the **INSTANT COOK/START** button to start cooking. (The display will count down through defrosting time)



x1, the display will show:



x1, display:

#### NOTES:

- The weight or quantity of the food can be input by pressing the **WEIGHT UP/DOWN** button until the desired weight/quantity is displayed. Enter the weight of the food only. Do not include the weight of the container.
- For food weighting more or less than the weights/quantities given in the AUTO MENU chart on page E-13, cook by manual operation.

## AUTO MENU CHART



Auto Menu	WEIGHT/ PORTION / UTENSILS	Procedure
Popcorn	0.05kg, 0.1kg	Place the popcorn bag directly on the turntable (Please see the note below: 'Important Information About Microwave Popcorn Feature')
Baked Potato	1, 2, 3 potatoes (pieces) 1 potato = approx. 0.23kg (initial temp. 20° C)	Please use potatoes with a similar size of approx. 0.23Kg. Pierce each potato in several places and place towards the edge of the turntable. Turn over and re-arrange halfway through cooking. Stand for 3 - 5 minutes before serving.
Pizza	0.1kg, 0.2kg, 0.4kg Plate (initial temp 5°C)	Place the pizza on a plate in the centre of the turntable. Do not cover.
Frozen vegetable e.g. Brussel sprouts, green beans, peas, mixed vegetables, broccoli	0.15kg, 0.35kg, 0.5kg Bowl (initial temp -18°C)	Place vegetables in a suitable container. Add 1tbsp of water per 0.1Kg of vegetables, cover the dish and place on the turntable. Stir halfway through cooking and after cooking.
Beverage (120ml/ cup)	1, 2, 3 Cup (initial temp. 5° C)	Place the cup(s) on the turntable and stir after heating.
Dishes	0.25kg, 0.35kg, 0.5kg Plate (initial temp. 5° C)	Place your dinner plate of food (such as meat, vegetable and rice/potatoes) in the centre of the turntable and follow the instructions on page E-12. It is always good to stir at the end to get an even temperature.

### Notes:

- The final temperature will vary according to the initial food temperature. Check if the food is piping hot after cooking. If necessary, you can extend the cooking manually.
- The results when using auto cook depend on variances such as the shape and size of the food and your personal preference as regards cooking results. If you are not satisfied with the programmed result, please adjust the cooking time to match your requirement.

### Important Information about Microwave Popcorn Feature:

1. When selecting 0.1kg of popcorn, it is suggested that you fold down a triangle on each corner of the bag before cooking. Refer to the picture on the right.



2. If/When the popcorn bag expands and no longer rotates properly, please press **STOP/CLEAR** key once and open the oven door and adjust the bag position to ensure even cooking.

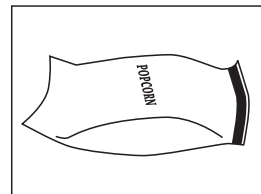



## SUITABLE OVENWARE

To cook/defrost food in a microwave oven, the microwave energy must be able to pass through the container to penetrate the food. Therefore it is important to choose suitable cookware.

Round/oval dishes are preferable to square/oblong ones, as the food in the corners tends to overcook. A variety of cookware can be used as listed below.

Cookware	Microwave Safe	Comments
Aluminium foil Foil Containers	✓ / ✗	Small pieces of aluminium foil can be used to shield food from overheating. Keep foil at least 2cm from the oven walls, as arcing may occur. Foil containers are not recommended unless specified by the manufacturer. Follow instructions carefully.
Browning dishes	✓	Always follow the manufacturers' instructions. Do not exceed heating time given. Be very careful as these dishes can be very hot.
China clay and ceramics	✓ / ✗	Porcelain, pottery, glazed earthenware and bone china are usually suitable, except for those with metallic decoration.
Glassware	✓	Care should be taken if using fine glassware as it can break or crack if heated suddenly.
Metal	✗	It is not recommended to use metal cookware as it will arc, which can lead to fire.
Plastic/Polystyrene e.g fast food containers	✓	Care must be taken as some containers warp, melt or discolour at high temperatures.
Cling film	✓	It should not touch the food and must be pierced to let the steam escape.
Freezer/Roasting bags	✓	Must be pierced to let steam escape. Ensure bags are suitable for microwave use.
Paper - Plates, cups and kitchen paper	✓	Do not use plastic or metal ties, as they may melt or catch fire due to the metal 'arcing'.
Straw and wooden Containers	✓	Only use for warming or to absorb moisture. Care must be taken as overheating may cause fire.
Recycled paper and newspaper	✗	Always attend the oven when using these materials as overheating may cause fire. May contain extracts of metal which will cause 'arcing' and may lead to fire.



**WARNING:**  
When heating food in plastic or paper containers, monitor the oven due to the risk of ignition.



**CAUTION: DO NOT USE COMMERCIAL OVEN CLEANERS, STEAM CLEANERS, ABRASIVE, HARSH CLEANERS, ANY THAT CONTAIN SODIUM HYDROXIDE OR SCOURING PADS ON ANY PART OF YOUR MICROWAVE OVEN.**

**CLEAN THE OVEN AT REGULAR INTERVALS AND REMOVE ANY FOOD DEPOSITS - Keep the oven clean, or the oven could lead to a deterioration of the surface. This could adversely affect the life of the appliance and possibly result in a hazardous situation.**

#### **Oven exterior**

The outside of your oven can be cleaned easily with mild soap and water. Make sure the soap is wiped off with a moist cloth, and dry the exterior with a soft towel.

#### **Control panel**

Open the door before cleaning to de-activate the control panel. Care should be taken in cleaning the control panel. Using a cloth dampened with water only, gently wipe the panel until it becomes clean.

Avoid using excessive amounts of water. Do not use any sort of chemical or abrasive cleaner.

#### **Oven Interior**

1. For cleaning, wipe any splatters or spills with a soft damp cloth or sponge after each use while the oven is still warm. For heavier spills, use a mild soap and wipe several times with a damp cloth until all residues are removed. Do not remove the waveguide cover.

2. Make sure that mild soap or water does not penetrate the small vents in the walls which may cause damage to the oven.

3. Do not use spray type cleaners on the oven interior. Keep the waveguide cover clean at all times.

The waveguide cover is constructed from a fragile material and should be cleaned with care (follow the cleaning instructions above).

**NOTE:** Excessive soaking may cause disintegration of the waveguide cover.

The waveguide cover is a consumable part and without regular cleaning, will need to be replaced.

#### **Turntable and Turntable support**

Remove the turntable and turntable support from the oven.

Wash the turntable and turntable support in mild soapy water. Dry with a soft cloth. Both the turntable and the turntable support are dishwasher safe.

#### **Door**

To remove all trace of dirt, regularly clean both sides of the door, the door seals and adjacent parts with a soft, damp cloth. Do not use abrasive cleaner.

**NOTE:** A steam cleaner should not be used.

#### **Cleaning tip - For easier cleaning of your oven:**

Place half a lemon in a bowl, add 300ml (1/2 pint) water and heat on 100% for 10 -12 minutes.

Wipe the oven clean using a soft, dry cloth.



## TROUBLESHOOTING

Keep the power supply cord away from heated surface. If you think the oven is not working properly there are some simple checks you can carry out yourself before calling an engineer.

Follow this simple check below: Place half a cup of water on the turntable and close the door. Programme the oven to cook for 1 minute using 100% microwave power.

1. Does the oven lamp come on when it is cooking?
2. Does the turntable rotate?
3. Does the cooling fan work? (Check by placing your hand above the air vent openings.)
4. After 1 minute does the audible signal sound?
5. Is the water in the cup hot?
6. After 3 minutes, does the grill heating element become red?

If you answer "NO" to any question, first check that the oven is plugged in properly and the fuse has not blown. If there is no fault with either, check against the troubleshooting chart below.

**WARNING: Never adjust, repair or modify the oven yourself. It is hazardous for anyone other than a SHARP trained engineer to carry out servicing or repairs. This is important as it may involve the removal of covers that provide protection against microwave energy.**

- The door seal stops microwave leakage during oven operation, but does not form an airtight seal. It is normal to see drops of water, light or feel warm air around the oven door. Food with a high moisture content will release steam and cause condensation inside the door which may drip from the oven.
- **Repairs and Modifications:** Do not attempt to operate the oven if it is not working properly.
- **Outer Cabinet & Lamp Access:** Never remove the outer cabinet. This is very dangerous due to high voltage parts inside which must never be touched, as this could be fatal.  
Your oven is not fitted with a lamp access cover. If the lamp fails, do not attempt to replace the lamp yourself, contact your nearest service centre approved by SHARP .

### TROUBLESHOOTING CHART

QUERY	ANSWER
Draught circulates around the door.	When the oven is working, air circulates within the cavity. The door does not form an airtight seal so air may escape from the door.
Condensation forms in the oven, and may drip from the door.	The oven cavity will normally be colder than the food being cooked, and so steam produced when cooking will condense on the colder surface. The amount of steam produced depends on the water content of the food being cooked. Some foods, such as potatoes have a high moisture content. Condensation trapped in the door glass should clear after a few hours.
Flashing or arcing from within the cavity when cooking.	Arcing will occur when a metallic object comes into close proximity to the oven cavity during cooking. This may possibly roughen the surface of the cavity, but would not otherwise damage the oven.
Arcing potatoes.	Ensure all "eyes" are removed from the potatoes and that they have been pierced, place directly onto the turntable or in a heat resistant flan dish or similar.
The display is lit but the control panel will not work when pressed.	Check the door is closed properly.
Oven cooks too slowly.	Ensure correct power level has been selected.
Oven makes a noise.	The microwave energy pulses ON and OFF during cooking/defrosting.
Outer cabinet is hot.	The cabinet may become hot to touch , keep children away.



