

SHARP[®]

香港電器安全規格
(國際電工委員會規格適合)

4T-C60AM1H
4T-C70AM1H

液晶彩色電視機
LCD COLOUR TELEVISION
使用說明書
OPERATION MANUAL

SHARP[®]
SHARP CORPORATION

AQUOS

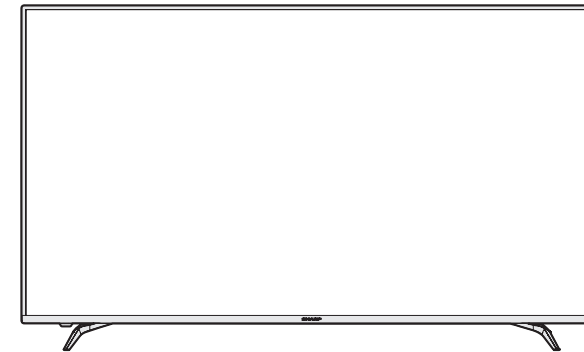

TINS-H147WJZZ

HDMI[®]
HIGH-DEFINITION MULTIMEDIA INTERFACE

DOLBY AUDIO[™]

DOLBY VISION[™]

Bluetooth[®]

micro

dts[®]
2.0+Digital Out

中文

ENGLISH



使用說明書

親愛的SHARP顧客

衷心感謝惠購SHARP液晶彩色電視機。為確保安全使用本機及令本機更加耐用，在使用本產品之前請務必仔細閱讀關於安全的重要注意事項。

目錄

引言

親愛的 SHARP 顧客	1
目錄	1
日常使用的注意事項	3
關於安全的重要注意事項	4
商標	5
免責聲明	6
附件	7

準備

安裝底座組件	8
簡易平台的製作方法 (只適用於 4T-C70AM1H)	9
壁掛電視機的處置和注意事項	10
部件名稱	10
電視機 (前視圖)	10
電視機 (後視圖)	11
遙控器	12
電視機操作按鈕	13
配對遙控器	13
在開啟電源之前	14
連接外部設備	15
使用數碼音頻輸出	16
插入 Micro SD 記憶卡	16
連接 USB 存儲設備	16
連接到網絡	16
裝入電池	17
關於遙控器的注意事項	17
開啟或關閉電視機	18
首次開啟電視機	18
關閉電視機	18
用戶指南	18

觀看電視

選項表	19
數字鍵盤	19
圖像設置	19
圖像模式	19
對比度/亮度/色調/銳度/彩色/背光	19
關閉屏幕	19
寬屏模式	19
高級設置	19
伽瑪校正	19
色溫	19
數碼抑噪	19
動態對比度	19
Fine Motion	19
智能對比度	19
HDR伽瑪校正	19
還原	20
聲音設置	20
聲音模式	20
自動音量	20
低音/高音/平衡	20
環繞聲	20
數碼音頻輸出	20
聲音切換	20
還原	20
頻道相關	20

目錄

觀看電視 (續)

頻道列表	20
頻道標籤	20
頻道排序	21
頻道跳越	21
頻道刪除	21
訊息	21
節目指南	21
自動搜台	21
手動搜台	21
訊號強度	21
音頻語言	21
字幕語言	21
畫中畫	21
HDMI選項	22
HDMI設置	22
HDMI選擇	22
電腦顯示模式	22
連動設定	22
TV設置	22
基本設置	22
開機狀態	22
定時關機	22
待機指示燈	22
語言設置	22
更多設置	22
預設輸入法	22
極速啟動	22
無訊號自動關機	22
按鍵音	22
畫中畫尺寸	22
數碼音頻語言	22
字幕	22
網絡	22
應用	22
系統	23
系統訊息	23
法律訊息	23
本地升級	23
系統還原	23

網絡功能

連接到網絡	24
無線安裝準備	24
有線安裝準備	24
網絡設置	25
無線網絡	25
有線網絡	25
藍牙	25
我的設備名	25
網絡訊息	25

智能功能

智能界面	26
安裝應用	26
應用	26
存儲空間	26
允許未知來源	26
應用管理	26
SD卡格式化	26
SD卡安全卸載	26
瀏覽器	26

其他有用功能

連接 USB 存儲設備	27
播放 USB 存儲設備中的檔案	27
用於 USB 多媒體選項表操作的按鈕	28
與 USB 模式相容的檔案列表	29

附錄

故障分析	30
規格	31
輪廓圖	32

日常使用的注意事項

請遵守以下事項

外殼的保養方法

- 清潔外殼的時候，請用柔軟的布（棉、絨等質料）輕輕地擦拭。請不要使用附有化學成分的乾、濕抹布，因為這樣會導致外殼本體成分的變質或裂開。
- 請注意不要使用質地堅硬的布來擦拭，或擦拭時過於用力，這樣會導致外殼表面劃傷。
- 外殼不潔的時候，可使用柔軟的布（棉、絨等質料）浸取少量稀釋過的中性洗劑，擰乾後擦拭，然後再用柔軟的乾布擦乾。
- 由於外殼為塑膠製品，汽油、稀釋劑類的溶劑會導致其變質，或塗料脫落，所以請不要使用此類溶劑來清潔外殼。
- 由於塑膠中含有塑化劑，與某些物質接觸會出現變質、塗料脫落等狀況，所以請遠離殺蟲劑等揮發性物質。另外，請不要與橡膠和樹脂類製品長期接觸。

屏幕的保養方法

- 在開始清潔屏幕之前，請務必關閉電視機電源，並將電源插頭從插座中拔出。
- 清潔屏幕時，請使用柔軟的乾布（棉、絨等質料）來輕輕擦拭屏幕表面。為了保護屏幕，請不要使用不乾淨的布、清洗劑、或附有化學成分的乾、濕抹布等物品來擦拭，因為這樣會造成顯示屏表面的剝落。
- 請注意不要使用質地堅硬的布來擦拭，或擦拭時過於用力，這樣會導致顯示屏表面劃花。
- 屏幕不潔的時候，可以用柔軟的布（棉、絨等質料）稍微用水打濕後，輕輕地擦拭（擦拭時不可過於用力，以免造成顯示屏表面劃花）。
- 如果液晶顯示屏表面黏上了灰塵，請使用市面有售的除塵刷（除靜電刷）來清潔。

關於安全的重要注意事項

- 清掃 — 在清掃本機之前，務必先將交流電源線插頭從交流電源插座中拔出。用擰乾的濕布將本機擦拭乾淨。請勿使用液態清潔劑、噴霧清潔劑或化學布料清潔，因為這類材質可能會對產品造成損害。

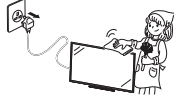

- 水和潮濕 — 不要在近水之處使用本機，例如在靠近洗澡盆、洗臉盆、廚房洗滌槽、洗衣盆、游泳池等，也不要潮濕的地下室中使用。



- 請勿在本機之上放置花瓶或任何其他盛水的容器，或將本機放置在冷氣機、加濕器等電器下面。若有水滴濺到本機之上，就可能引起火災或觸電。



- 台座 — 不要將本機放置於不穩定的推車、台座、三腳架或桌面上。不穩固的基座可能會使本機掉落，導致嚴重的人身傷害、以及產品損壞。請僅使用本製造商所推薦或與本產品配套出售的推車、台座、三腳架、托架或桌子。將本機安裝於牆上時，請務必遵照本製造商的指示，而且只可以使用本製造商所推薦的安裝器材。



- 將本機放置於推車上搬運時，必須小心注意安全。急停、用力過度、地面不平等等，都會導致本機從推車上掉落。



- 通風 — 本機外殼上的散熱孔與其他開口之處，用於散熱通風。請勿堵塞這些散熱孔或開口之處，通風散熱不良會使本機過熱、縮短本機的使用壽命。請勿將本機置於臥床、沙發、地毯或其他類似物品之上，因為這些物品會堵塞散熱通風孔。本產品之設計不適用於嵌入式安裝，所以不要將本機置於像書櫃、機架等封閉之處，除非提供合適的通風或遵照本製造商的專門指示說明。



- 本機如果不慎掉落，外殼破損，請務必關閉本機電源，並拔出插頭。如果繼續使用，會有火災和觸電的危險。



- 請不要打開後殼改造電路。內部存在高電壓，會引起觸電傷害。如果需要檢修，請聯絡經銷商。



- 本機所用之液晶顯示屏是用玻璃製造的。因此，在受到強力撞擊或被尖銳物刻劃時會損壞。萬一液晶顯示屏破碎，請小心不要受到碎玻璃的割傷。

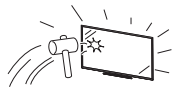

- 熱源 — 請勿讓本機接近熱源，如取暖器、加熱器、火爐或其他任何會產生熱力的東西（包括擴音機在內）。



- 為防止發生火災，請勿將任何種類的蠟燭或火焰置於本機的頂部或其附近。

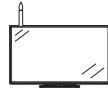

- 為了防止遭受起火或觸電的危險，請勿將交流電源線置於本機或其他重物之下。

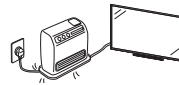

- 請勿在本機之上放置重物或攀爬於本機之上。這樣做可能導致本機傾倒而造成傷害。特別要注意近旁的兒童和寵物。



- 搬運電視機之前，請先把插頭拔出。如果不預先拔出，很容易拉損電源線，產生觸電危險。

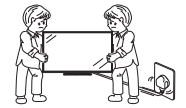

液晶顯示屏是用非常高超的技術製造的，具有 8,294,400 個像素，能顯示出精細的畫面。

由於像素數目極多，偶然也可能會有一些無效的像素出現在屏幕上，看上去是固定不變的藍色、綠色或紅色的亮點。請注意，這是屬於產品規格範圍之內，並不是故障。

在搬運電視機時的注意事項

- 在搬運電視機時，切勿握住顯示屏搬運或使顯示屏受到壓力。在搬運本電視機時，無論何時都必須由兩個人以上用雙手搬運 — 電視機的每一側用一隻手握住。

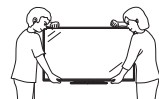

- 請勿長時間顯示靜止影像，這可能會導致殘留影像。

- 請將本機安裝於能將交流電源線容易從交流電源插座拔出的地方。

註

- 以上均為示意圖，以實物為準。

商標

- Dolby, Dolby Audio, Dolby Vision, 和雙D記號是杜比實驗室的商標。本產品經過杜比實驗室的授權而製造。未公佈的機密作品。版權所有1992–2015杜比實驗室。保留所有權利。
- HDMI、HDMI高清晰度多媒體接口及HDMI 商標為HDMI Licensing Administrator, Inc. 於美國及其他國家的商標或註冊商標。
- For DTS patents, see <http://patents.dts.com>. Manufactured under license from DTS Licensing Limited. DTS, the Symbol, DTS and the Symbol together, Digital Surround, and the DTS 2.0+Digital Out logo, are registered trademarks and/or trademarks of DTS, Inc. in the United States and/or other countries. © DTS, Inc. All Rights Reserved.
- Wi-Fi CERTIFIED 標誌是 Wi-Fi 聯盟的認證標誌。
- SDHC logo is a trademark of SD-3C, LLC
- MPEG Layer-3 audio coding technology licensed from Fraunhofer IIS and Thomson.
- THIS PRODUCT IS LICENSED UNDER THE AVC PATENT PORTFOLIO LICENSE FOR THE PERSONAL USE OF A CONSUMER OR OTHER USES IN WHICH IT DOES NOT RECEIVE REMUNERATION (i) ENCODE VIDEO IN COMPLIANCE WITH THE AVC STANDARD ("AVC VIDEO") AND/OR (ii) DECODE AVC VIDEO THAT WAS ENCODED BY A CONSUMER ENGAGED IN A PERSONAL ACTIVITY AND/OR WAS OBTAINED FROM A VIDEO PROVIDER LICENSED TO PROVIDE AVC VIDEO. NO LICENSE IS GRANTED OR SHALL BE IMPLIED FOR ANY OTHER USE. ADDITIONAL INFORMATION MAY BE OBTAINED FROM MPEG LA, L.L.C. SEE [HTTP://WWW.MPEGLA.COM](http://www.mpegla.com)
- THIS PRODUCT IS LICENSED UNDER THE MPEG-4 VISUAL PATENT PORTFOLIO LICENSE FOR THE PERSONAL AND NON-COMMERCIAL USE OF A CONSUMER FOR (i) ENCODING VIDEO IN COMPLIANCE WITH THE MPEG-4 VISUAL STANDARD ("MPEG-4 VIDEO") AND/OR (ii) DECODING MPEG-4 VIDEO THAT WAS ENCODED BY A CONSUMER ENGAGED IN A PERSONAL AND NON-COMMERCIAL ACTIVITY AND/OR WAS OBTAINED FROM A VIDEO PROVIDER LICENSED BY MPEG LA TO PROVIDE MPEG-4 VIDEO. NO LICENSE IS GRANTED OR SHALL BE IMPLIED FOR ANY OTHER USE. ADDITIONAL INFORMATION INCLUDING THAT RELATING TO PROMOTIONAL, INTERNAL AND COMMERCIAL USES AND LICENSING MAY BE OBTAINED FROM MPEG LA, L.L.C. SEE [HTTP://WWW.MPEGLA.COM](http://www.mpegla.com)
- Bluetooth 文字標誌和圖形標誌為 Bluetooth SIG, Inc. 所有的註冊商標，且SHARP 在授權下使用任何該等標記。其他商標和商名為各自所有者的商標和商名。
- This product is protected by certain intellectual property rights of Microsoft. Use or distribution of such technology outside of this product is prohibited without a license from Microsoft.

免責聲明

DISCLAIMERS







- This SHARP device facilitates the access to content and services provided by third parties. The content and services accessible via this device belong to and may be proprietary to third parties. Therefore, any use of such third party content and services must be in accordance with any authorization or terms of use provided by such content or service provider. SHARP shall not be liable to you or any third party for your failure to abide by such authorization or terms of use. Unless otherwise specifically authorized by the applicable content or service provider, all third party content and services provided are for personal and non-commercial use; you may not modify, copy, distribute, transmit, display, perform, reproduce, upload, publish, license, create derivative works from, transfer or sell in any manner or medium any content or services available via this device.
- SHARP is not responsible, nor liable, for customer service-related issues related to the third party content or services. Any questions, comments or service-related inquiries relating to the third party content or service should be made directly to the applicable content or service provider.
- You may not be able to access content or services from the device for a variety of reasons which may be unrelated to the device itself, including, but not limited to, power failure, other Internet connection, or failure to configure your device properly. SHARP, its directors, officers, employees, agents, contractors and affiliates shall not be liable to you or any third party with respect to such failures or maintenance outages, regardless of cause or whether or not it could have been avoided.
- All third party content or services accessible via this device is provided to you on an “as-is” and “as available” basis and SHARP and its affiliates make no warranty or representation of any kind to you, either express or implied, including, without limitation, any warranties of merchantability, non-infringement, fitness for a particular purpose or any warranties of suitability, availability, accuracy, completeness, security, title, usefulness, lack of negligence or error-free or uninterrupted operation or use of the content or services provided to you or that the content or services will meet your requirements or expectations.
- SHARP is not an agent of and assumes no responsibility for the acts or omissions of third party content or service providers, nor any aspect of the content or service related to such third party providers.
- In no event will SHARP and/or its affiliates be liable to you or any third party for any direct, indirect, special, incidental, punitive, consequential or other damages, whether the theory of liability is based on contract, tort, negligence, breach of warranty, strict liability or otherwise and whether or not SHARP and/or its affiliates have been advised of the possibility of such damages.

- 本使用說明書已進行過嚴格的校勘和核對，但因軟體升級等因素，SHARP 不能保證用戶實際操作與說明書描述完全一致。

附件

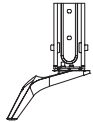
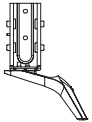
隨機附件

請確認如下附件隨同本機附送。

遙控器		
		
插入電池使用。 第 12 頁		
“AA” 型電池 (× 2)	使用說明書	
		
底座組件		
4T-C60AM1H		
“L” 底座組件	“R” 底座組件	
		
底座組件		螺絲釘 (× 4)
底座組件		
4T-C70AM1H		
“L” 底座組件	“R” 底座組件	
		
底座組件		螺絲釘 (× 4)

準備

安裝底座組件

- 安裝底座組件時，需將電視機正面朝下平放在平台上。
- 在安裝（或拆卸）底座組件之前，請將交流電源線從交流電源插座中拔出。
- 在執行操作之前，請在將放置電視機的地方鋪設減震墊，以防電視機損壞。

注意

- **正確安裝底座組件。**
- **請務必遵照說明進行安裝。若底座組件安裝不正確，則可能導致電視機傾倒。**

1

將電視機如圖平放於軟墊上，左右底座組件分別插入電視機底部的凹槽內，請確保底座支架上的凸起部分插入到電視機本體下部的凹槽里。

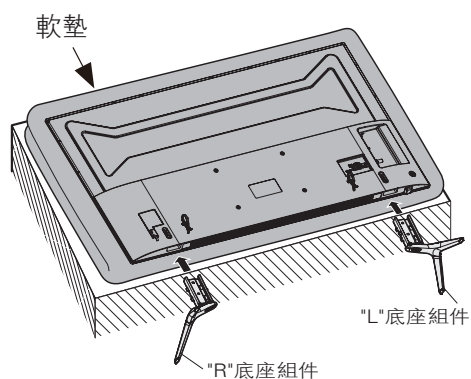

註

- 安裝底座時，需將電視機正面向下平放在平台上，平放前先在平台上鋪一層軟墊。
- 若要拆下底座組件，請按相反的順序執行以上步驟。
- 底座組件不允許調節角度。
- 本產品未有附帶螺絲批。
- 在安裝過程中，請小心操作，以免您的手被電視機底部和地面夾到。

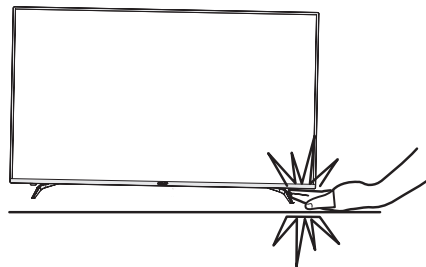

2

將4枚螺絲釘插入到電視機背面的4個螺絲孔中並擰緊。

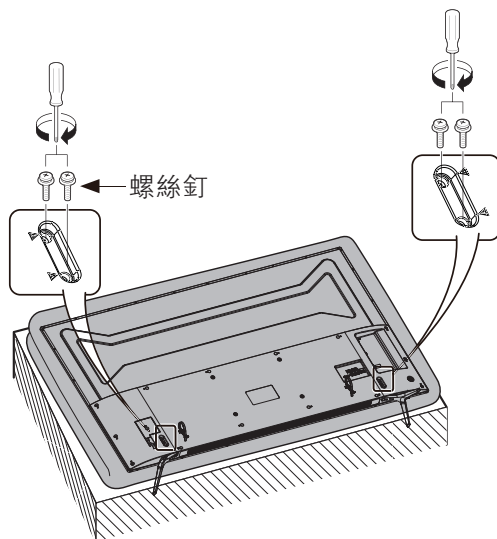

準備

簡易平台的製作方法 (只適用於 4T-C70AM1H)

要製作簡易平台，需使用包裝箱及其內部的 3 個發泡膠，TOP-L、TOP-C、TOP-R。

1 如下圖所示，請取下紙箱底部的卡扣。

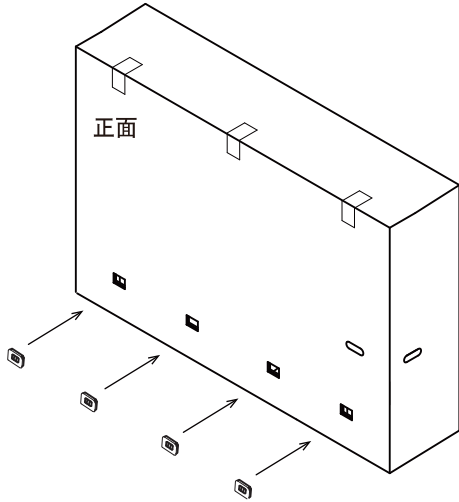

2 按下圖所示方法，請從頂部拆開包裝箱，並取出頂面的 3 個發泡膠 (TOP-L、TOP-C、TOP-R)。

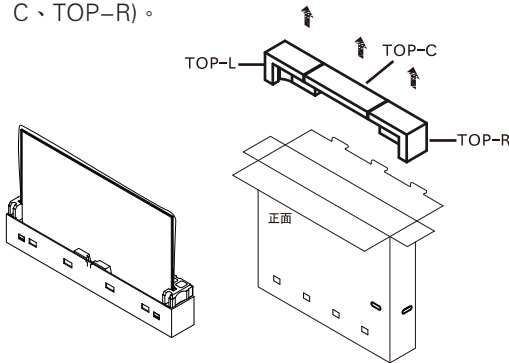

3 1 如圖 A 所示，請將包裝箱正面向下放置。
2 將 TOP-L 和 TOP-R 分別裝入包裝箱內的右側和左側。(裝入位置如圖 B 所示)
3 將 TOP-C 裝入包裝箱內的中間部位 (裝入位置如圖 B 所示)，即完成簡易平台的製作。

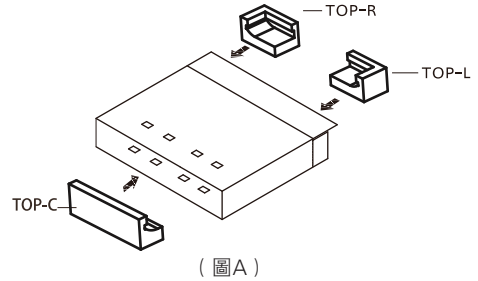

(圖A)

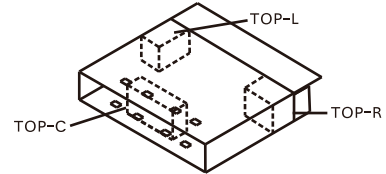

(圖B)

註

- 簡易平台製作完成後，請放置在平坦的地面上。
- 安裝底座時，需要將電視機正面向下平放，平放前請先在平台上鋪設一層軟墊以保護屏幕。
- 簡易平台只是臨時平台，請不要施加超過液晶電視機重量的負荷。

準備

壁掛電視機的處置和注意事項

- 可用另外購買的托架，將電視機安裝在牆上。
- 詳情請參閱另外購買的托架所附之說明書。

注意

- 本電視機只能使用 SHARP 公司推薦的掛牆架來將電視機安裝到牆上。使用其他掛牆架可能導致安裝不穩而引致嚴重人身傷害。
- 安裝液晶彩色電視機需要特別的技能，只有具有專業資格的服務人員才能夠安裝。用戶不可自己進行這項工作。對於不正確的安裝，或是由於安裝引起的事故或傷害，SHARP 不承擔任何責任。

使用另外購買的托架來安裝電視機

- 可請經資質認證的服務人員用另外購買的托架將電視機安裝到牆上。
- 在開始操作之前，請先仔細閱讀隨同托架提供的使用說明書。

部件名稱

電視機（前視圖）

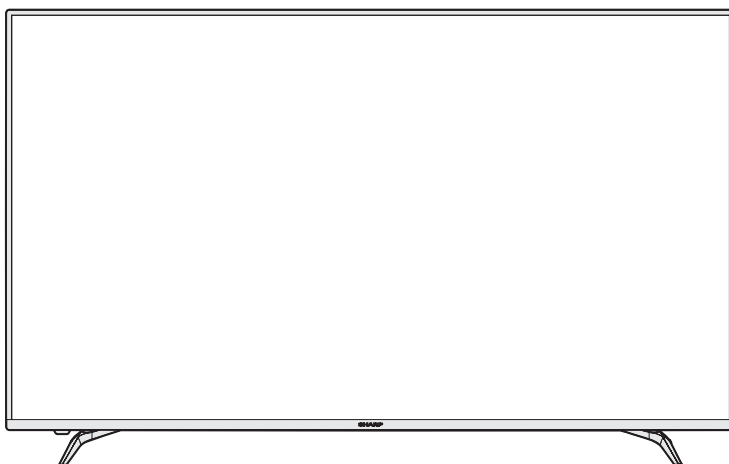

- 本說明書中的插圖和螢幕顯示是以解釋為目的，可能與實際操作略有差別。
- 本說明書中所有插圖全部是根據 4T-C60AM1H 進行說明。

準備

電視機 (後視圖)

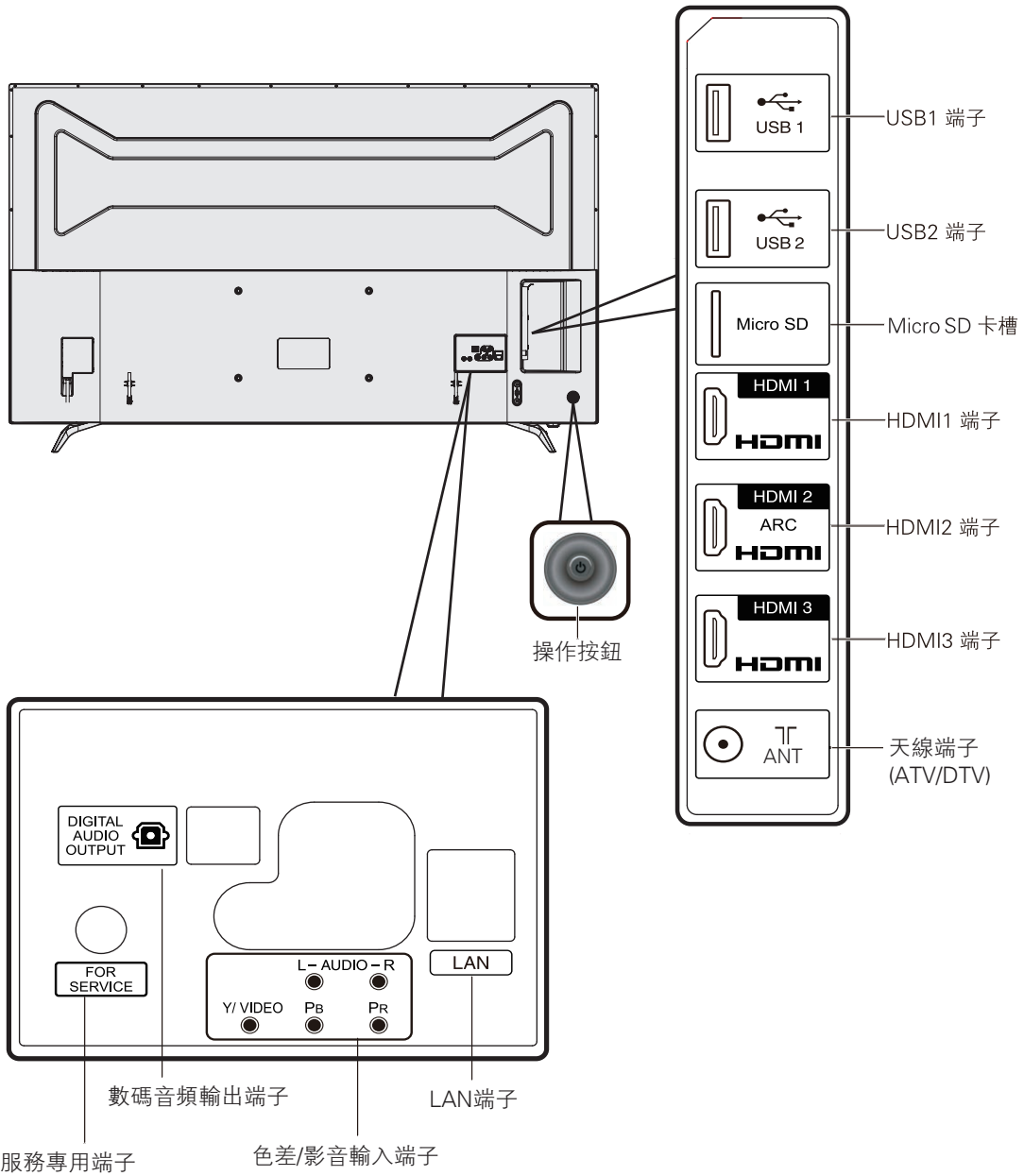

準備

遙控器

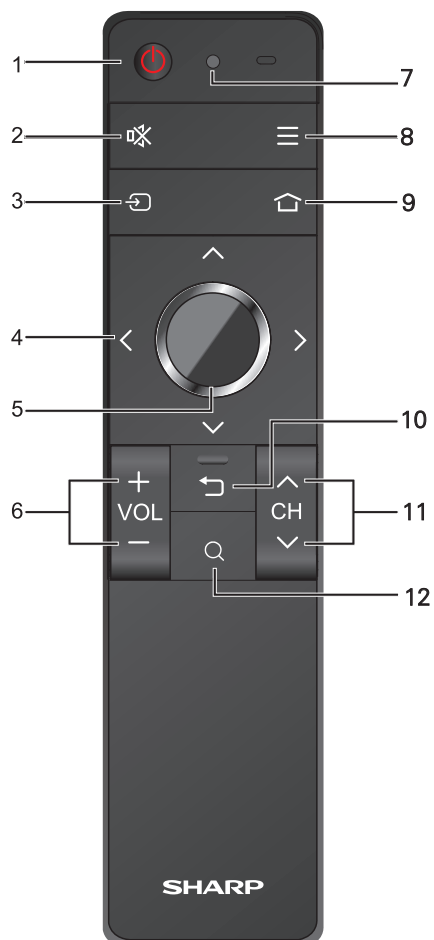

- 1 **POWER (電源備用 / 開啟)**
開啟和關掉電源。(請參閱第 18 頁。)
- 2 **靜音**
關閉聲音。
- 3 **信源**
全屏顯示電視節目時，可選擇一個信源。按下信源，按下 ◀/▶，選擇您想觀看的信源。
- 4 **▲/▼/◀/▶ (游標)**
在設置畫面上選擇一個所需的項目。
- 5 **OK (輸入)**
執行一個命令。
- 6 **VOL +/- (音量 +/-)**
設置音量。
- 7 **遙控器指示燈**
顯示遙控器工作狀態。
- 8 **☰ (選項表)**
顯示電視機的選項表。
- 9 **🏠**
按該鈕進入智能界面。
- 10 **↶ (返回)**
返回到前一個選項表畫面。
- 11 **CH ▲/▼ (頻道 ▲/▼)**
電視輸入模式：選擇上一個 / 下一個頻道。
- 12 **Q (瀏覽器)**
按該鈕進入瀏覽器界面 (初次使用請先安裝瀏覽器)。

註

當遙控器處於休眠時，只需按下遙控器上的任何按鍵 (除電源鍵外) 去喚醒遙控器便可使用。

遙控器指示燈

指示燈	閃燈效果	指示狀態	功能說明
藍燈	快速閃爍	提醒	遙控器配對開始。
	持續亮3秒	提醒	遙控器配對成功。
紅燈	持續3秒慢閃	警告	遙控器電量不足，此時遙控器仍可使用。
	持續3秒快閃	警告	遙控器電量嚴重不足。此時遙控器不可使用。
	持續亮3秒	警告	遙控器配對超時，遙控器配對不成功。
藍燈、紅燈	交替閃爍	提醒	解除現在的遙控器與電視機之間的配對，此時新遙控器可與電視進行配對。

準備

電視機操作按鈕

您也可以使用電視機上的操作按鈕來進行電視設置。
(電視機的操作按鈕位置請參閱第 11 頁的電視機後視圖。)



按鈕動作	功能
短按	電視開機狀態下：開機
左 / 右	音量 減 / 加
上 / 下	頻道 上 / 下
長按	電視機開機狀態下：顯示選項 (配對 / 關機) (遙控器配對請參閱本頁。)

配對遙控器

隨本機附送的遙控器在出廠前已經與電視配對，可以直接使用。如果您發現遙控器無法正常操控電視或更換了新的遙控器時，請按照下面方法將遙控器與電視進行配對。

- 1 長按電視機上的電源按鈕，畫面會顯示“配對”、“關機”的選項。
- 2 使用電視機背部的按鈕，選擇“配對”，然後按下電視機操作按鈕。
- 3 將遙控器靠近電視機正下方 (SHARP 商標) 附近。同時按下遙控器上的 **OK** 和 ，直到遙控器紅藍燈交替閃爍完畢。
- 4 再次按下 **OK**，直到畫面提示配對成功。

註

- 如果電視機沒有顯示遙控器配對資訊時，電視機會自動顯示“配對”界面。按下遙控器上的 **OK** 和 ，遙控器會紅藍燈交替閃爍，待閃爍停止後，再次按下 **OK**，直到畫面提示配對成功。
- 若遙控器配對不成功，請再嘗試一次或與客戶服務中心聯繫。

準備

在開啟電源之前

設置電視機位置之說明

- 勿使電視機受到陽光直射，並將其置於通風良好之處。
- 請將電視機置於水平的地方。
- 在連接交流電源線之前，請勿開啟電視機的電源。
- 若本機外殼上貼有保護膜，為了確保正常使用本機，請在使用前將其去除。

1 連接天線

為了能盡情享受清晰的電視影像，請使用室外電視天線。以下是關於同軸連接線的連接方法之簡要說明。

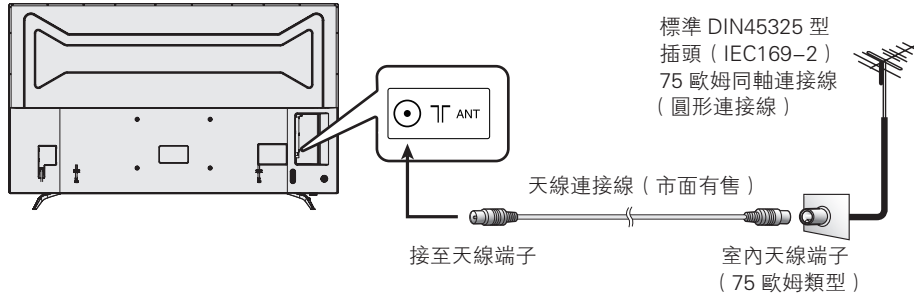

2 連接外部設備

關於連接錄影機和 DVD 影碟機等的外部設備，請參閱第 15 頁和第 16 頁。

3 將交流電源線插入交流電源插座。

- 1 將天線連接到電視機的背面。
- 2 將電視機的交流電源插頭插入交流電源插座。

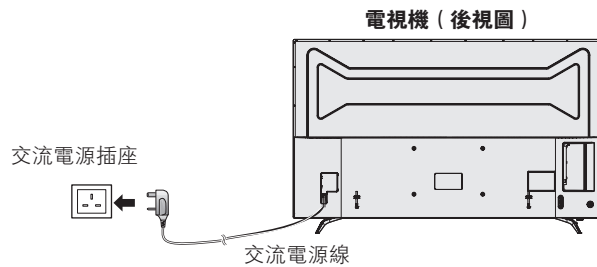

- 請將電視機置於靠近交流電源插座之處，並使電源插頭便於插拔。
- 如長期不使用本電視機，請將交流電源線從交流電源插座中拔出。

4 捆綁電線

如圖所示，將電線夾插入電視機上的孔中，並把電線放入電線夾內捆綁。

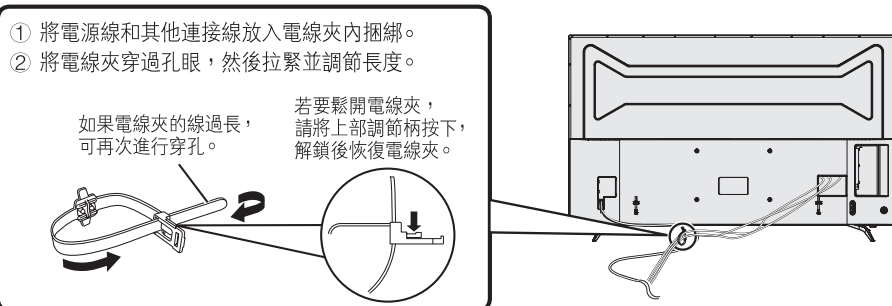

注意

- 為了防止遭受電擊的危險，在連接著電源線時，請不要觸碰接線任何未經絕緣的部份。

準備

連接外部設備

可將許多類型的外部設備連接到電視機上，如數碼電視機機頂盒 (STB)、錄影機、遊戲機、攝錄機、DVD 影碟機和電腦等。要觀看外接源的影像，請按遙控器上的信源鍵或從智能界面上的信源圖標，選擇您想要進入的輸入源，按下**OK**進入。

注意

- 為保護所有的設備，在連接錄影機、遊戲機、攝錄機、DVD 影碟機、數碼電視機機頂盒 (STB)、電腦或其他設備之前，請務必先關閉電視機的電源。
- 在進行連接之前，請仔細閱讀有關的使用說明書 (數碼電視機機頂盒 (STB)、錄影機、DVD 影碟機等)。

當使用HDMI (高清晰度多媒體接口) 連接線時 (市面有售)

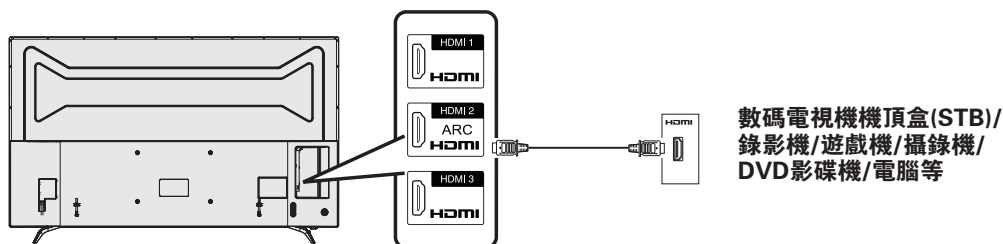

註

- 使用電視機機頂盒觀看電視節目時，請使用機頂盒遙控器切換頻道。

當使用色差連接線時 (市面有售)

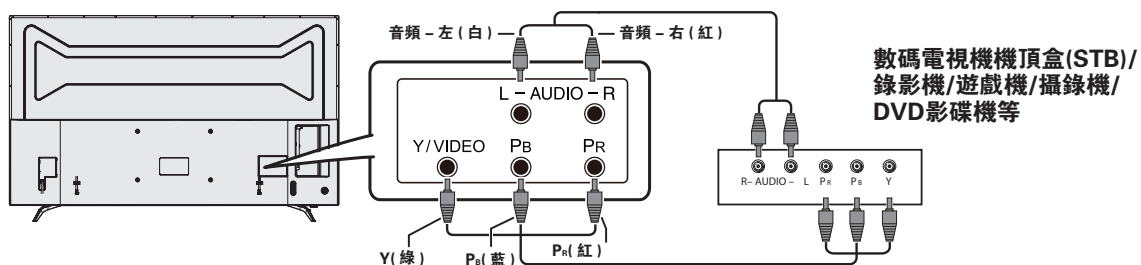

註

- 請按顏色插入各個端子。
- 色差與影音端子共用。

當使用影音連接線時 (市面有售)

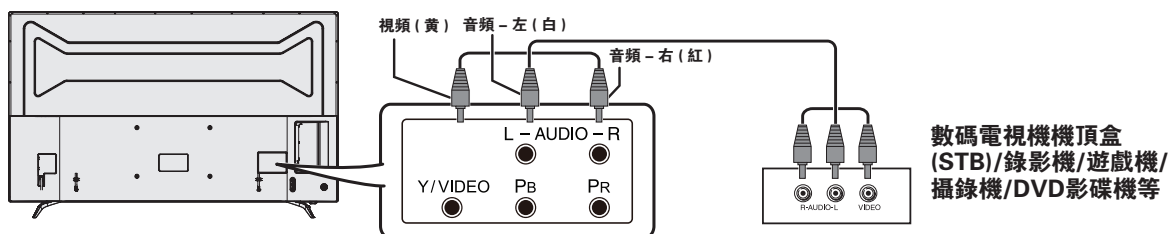

註

- 請按顏色插入各個端子。
- 色差與影音端子共用。

準備

使用數碼音頻輸出

能夠透過 DIGITAL AUDIO OUTPUT (數碼音頻輸出端子) 輸出音頻。從端子輸出 PCM 或 RAW (杜比數碼或 DTS 音頻)。

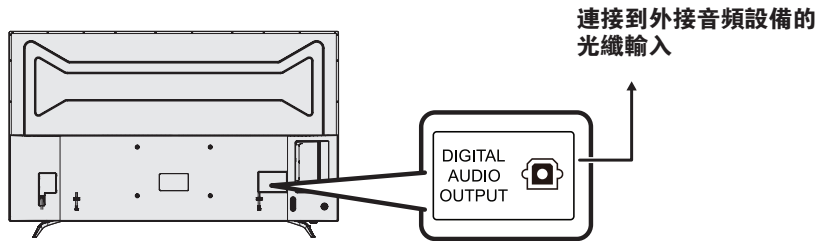

註

- DIGITAL AUDIO OUTPUT (數碼音頻輸出端子) 通常輸出與揚聲器相同的聲音 (正在觀看的節目的聲音從該端子輸出)。
- 由於設備和軟體的不同, DIGITAL AUDIO OUTPUT (數碼音頻輸出端子) 無法輸出某些信號。
- 當使用 DIGITAL AUDIO OUTPUT (數碼音頻輸出端子), 揚聲器會轉為靜音。

插入 Micro SD 記憶卡 (市面有售)

存取、讀取 Micro SD 記憶卡中的影片、音樂等檔案。請將儲存有相關檔案的 Micro SD 記憶卡插入 SD 卡槽。請參閱第 27 頁中, 有關 USB 裝置內的檔案如何播放的說明。

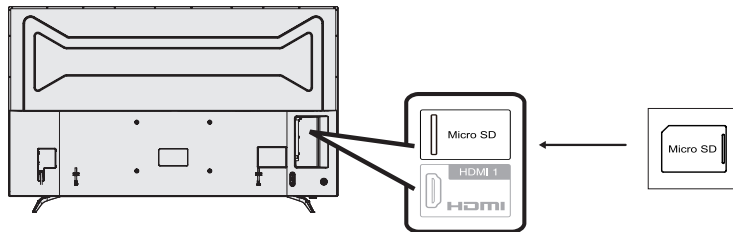

註

- 請按圖示方向將 Micro SD 卡插入卡槽中。
- SD 卡槽支援 Micro SD 類型的記憶卡, 但部分記憶卡可能無法支援。
- 本產品支援最高 32GB 的記憶卡, 請您盡量選用速度高於 Class4 的記憶卡, 以保證讀寫速度更快, 進而保證系統性能。
- 記憶卡需要在安全移除或關閉電視機後才可取下。
- 記憶卡不得執行熱插拔操作, 否則可能會令電視機故障。
- 請時常為記憶卡內的資料備份, 防止資料損壞或電視機運作錯誤。(若有任何儲存資料損壞或遺失, SHARP 恕不負責)

連接 USB 存儲設備

請參閱第 27 頁。

連接到網絡

請參閱第 24 頁和第 25 頁。

準備

裝入電池

在第一次使用本電視機之前，請插入兩枚“AA”型電池（附送）。當電池耗盡，而且遙控器不能操作時，用新的“AA”型電池替換。

1 打開電池蓋

圖① 一隻手握住遙控器前端，另一隻手拉住手繩的細繩部份。

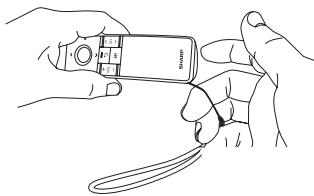

圖② 將大拇指置於底部凹槽處。

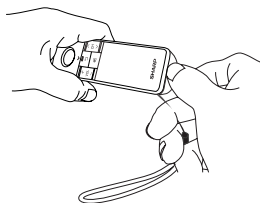

圖③ 用中指和食指向內拉手繩，用大拇指沿底部凹槽向外推開電池蓋。

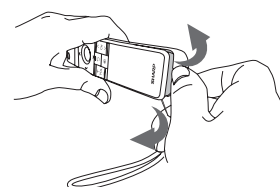

2 插入兩枚附送的“AA”型電池

在裝入電池時，要注意電池端子的極性要與電池艙內的極性標記（+）和（-）一致。

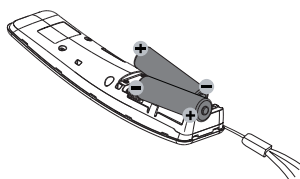

3 關上電池蓋

請把電池蓋由上而下蓋上。

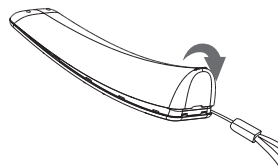

注意

如果電池使用不當，會導致化學物質泄漏或爆炸。請務必遵守如下所述的指示。

- 不要將不同型號的電池混合使用。不同型號的電池具有不同的特性。
- 不要將新舊程度不同的電池混合使用。如果新電池與舊電池混合使用，那麼就會縮短新電池的使用壽命，或導致舊電池的化學物質泄漏。
- 當電池的電量耗盡之時，要立即將電池取出。從電池漏出的化學物質會腐蝕電池艙內零件。如果發現有任何化學物質泄漏，那麼請用布將化學物質徹底擦拭乾淨。
- 由於儲存條件不同，隨同本機附送之電池可能會達不到預期的使用壽命。
- 如果將會長期不使用遙控器，那麼請將電池從遙控器中取出。
- 不要將電池暴露在如直射陽光、火等一些過熱的環境中。

關於遙控器的注意事項

- 切勿使遙控器受到劇烈震動。此外，切勿將遙控器浸泡於液體之中，或將其置於非常潮濕之處。
- 切勿在直射陽光下設置或放置遙控器。熱力將導致遙控器變形。

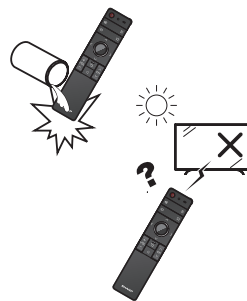

準備

開啟或關閉電視機

首次開啟電視機

電視機接上電源後，進入備用狀態。

按下遙控器或電視機上的 **⏻ (POWER)**：

- 電視機已經開啟。
- 您可以按下遙控器上的 **⏻ (POWER)** 按鍵進入備用模式。

關閉電視機

如在已開啟狀態下，按下遙控器上的 **⏻ (POWER)**：

- 電視機進入備用模式，屏幕上的影像消失。
- 按下遙控器上的 **⏻ (POWER)** 可再次開啟電視機。
- 如在以上備用模式下需要關閉電源，請拔出電視機電源線。

註

- 如果長時間不使用本電視機，請務必將交流電源線插頭從交流電源插座中拔出。
- 即使電視機處於備用狀態，也會略微消耗電量。
- 如遇特殊情況導致電視機突然斷電（如停電或電網波動），電視機再次通電後可能工作異常。此時請按下遙控器上的 **⏻ (POWER)** 或拔插電視機電源線來重新啟動電視機。
- 在觀看電視過程中，電視機溫度會升高，此為正常現象。
- 在電視機開啟、關閉過程中，運行應用程式或系統升級過程中，請勿隨意切斷電源，否則可能造成電視機故障。如需關閉電視機電源，請關閉所有應用程式，並正常關閉電視機後再關閉電視機電源。

用戶指南

購買電視機之後，當首次開啟電源時，就會顯示出開始設置的嚮導。請按照選項表所示，一步一步地進行所需的設置。

在開啟電源之前，請先確認以下事項。

- 是否已連接天線？
- 是否已將電源插頭插入電源插座？

按下電視上的 **⏻ (POWER) 按鈕。**

- 顯示開機畫面，之後顯示“語言設置”畫面。
- 第一次開機時間較長，請耐心等待。



■ 語言設置

可以將電視語言設置為“繁體中文”、“簡體中文”或“EN”。

■ 模式設置

如您是在家裡觀看電視，建議選擇“家居模式”。

- “家居模式”：“圖像模式”設置的預設值為“標準”。
- “商店模式”：僅商店展示時使用。“圖像模式”設置的預設值為“明亮”。

■ 網絡設置

您可以選擇“有線連接”或“無線連接”方式接入到網絡。請參閱第 24 頁和第 25 頁。

觀看電視

當初始設置完成後，即可進入電視的主頁面。如想觀看電視節目，按信源鍵選擇**信源**，按下**OK**，然後按**◀/▶**按鍵，選擇模擬電視/數碼電視或您的機頂盒所在的輸入源，然後按**OK**，電視螢幕開始播放選擇的節目或輸入源。

註

- 初次切換到ATV或DTV時，將執行自動頻道搜索。

選項表

數字鍵盤

可按下選項鍵選擇數字鍵盤，按下**OK**，輸入頻道號碼，來選擇您想要觀看的頻道。

圖像設置

用“圖像設置”功能可選擇適合於電視顯示器環境的音頻和視頻設定。

圖像模式

可供選擇的項目有：標準、電影、遊戲、護眼、體育、鮮豔、明亮、自定義、杜比視界明亮、杜比視界柔和、杜比視界動態。

對比度/亮度/色調/銳度/彩色/背光

可將影像調整到適合自己的喜好。

所選擇的項目	◀ 按鈕	▶ 按鈕
對比度	減弱對比度	增強對比度
亮度	降低顯示亮度	提高顯示亮度
色調	顏色偏紅	顏色偏綠
銳度	柔化圖像	銳化圖像
彩色	減淡顏色	加深顏色
背光	圖像變暗	圖像變亮

註

當圖像模式選擇“明亮”時，不能調整“對比度”、“亮度”、“色調”、“銳度”、“彩色”和“背光”。

關閉屏幕

按**◀/▶**選擇確認或取消，選擇確認後屏幕關閉，按除了電源鍵和音量鍵以外的任意鍵可再次打開屏幕。

寬屏模式

可以為每一種影像選擇不同的屏幕模式。

所選擇的項目	說明
標準	用於 4:3 標準影像。左右兩側都出現一個邊緣條。
14:9 縮放	用於 14:9 的信箱型影像。左右兩側出現一個狹窄的邊緣條，並且在某些節目情況下可以看見頂部和底部也出現邊緣條。
全景	在這種模式下，影像被一步步拉開到屏幕的兩側邊緣。
全屏	用於 16:9 擠壓型影像。
16:9 影院	用於 16:9 信箱型影像。在某些節目時頂部和底部可能出現邊緣條。
14:9 影院	用於 14:9 信箱型影像。在某些節目時頂部和底部可能出現邊緣條。

所選擇的項目	說明
逐點	在畫面上顯示同樣像素數目的影像（只適用於接收2160p訊號時）。
優化掃描	僅在接收720p/1080i/1080p訊號時顯示“優化掃描”影像。顯示高解像度影像時調節到最佳。對於某些節目，畫面邊緣可能會出現雜波。

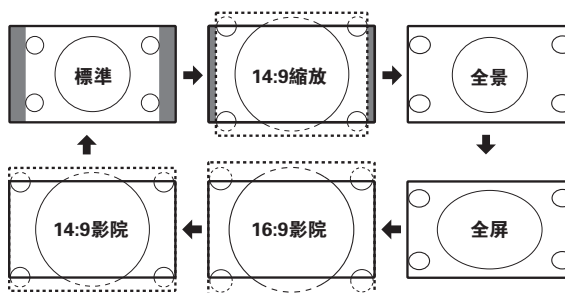

註

- 由於輸入訊號各有不同，有可能不會顯示某些影像尺寸。
- “14:9 縮放”和“14:9 影院”僅在ATV（模擬電視）或DTV（數碼電視）模式下有效。

高級設置

伽瑪校正

調節中間級別亮度。

色溫

調校色溫以得到最佳的白色平衡。

可供選擇的有：“低”、“中-低”、“中”、“中-高”或“高”。

數碼抑噪

減少畫面上的噪點，再現更加清晰的視頻影像。

可供選擇的有：“自動”、“關閉”、“低”、“高”。

動態對比度

根據畫面自動調節影像的對比度。

可選擇開啟或關閉該功能。

Fine Motion

使用“Fine Motion”功能可更清晰地觀賞高速運動的影像。

可供選擇的有：“關閉”、“標準”或“增強”。

註

僅適用於 24/30Hz 的輸入信號。

智能對比度

本功能將背光源進行精細分割，並以像素為單位分割影像，自動計算被拍攝物體的亮度資訊，重新構建畫面亮度，增強光線的散佈效率，提升畫面亮度。使明亮部分色彩艷麗，黑暗部分濃郁深邃。

可供選擇的項目有：“關”、“底”、“中”、“中-高”或“高”。

HDR伽瑪校正

調節HDR訊號輸入時的圖像。

觀看電視

還原

將所有的圖像調校項目重新設定為出廠預設值。

聲音設置

聲音模式

用“聲音模式”功能可選擇適合於電視使用環境的聲音設定。

可供選擇的項目有：標準、電影、新聞、音樂、自定義。

自動音量

不同的聲音來源有時音量也不同，如節目及插播的廣告時段。自動音量控制（自動音量）可通過平衡音量解決這個問題。

低音/高音/平衡

可以調整所選擇的聲音模式的音頻。

所選擇的項目	◀ 按鈕	▶ 按鈕
低音	減弱低音	增強低音
高音	減弱高音	增強高音
平衡	左側揚聲器出聲	右側揚聲器出聲

環繞聲

環繞聲功能從揚聲器產生出環繞聲效果。可選擇開啟或關閉該功能。

註

- 當聲音模式選擇“音樂”時，不能調整“自動音量”、“低音”、“高音”、“平衡”及“環繞聲”。

數碼音頻輸出

用該功能可選擇自己喜歡的音頻輸出制式。

所選擇的項目	說明
關閉	關閉數碼音頻輸出。
SPDIF-PCM	通過SPDIF光纖輸出PCM格式。
SPDIF-RAW	通過SPDIF光纖輸出原始數據格式。
ARC-PCM	通過HDMI音頻回傳，輸出PCM格式。
ARC-RAW	通過HDMI音頻回傳，輸出原始數據格式。

註

- 即使選擇了“RAW”，模擬音頻和視頻輸入音頻仍然按PCM格式輸出。
- 即使選擇了“RAW”，PCM輸入信號仍然按PCM格式輸出。
- 當使用數碼音頻輸出時，揚聲器會變為靜音。

聲音切換

在觀看多音頻或立體聲廣播節目時，可切換多種音頻模式。

在麗音電視廣播模式下

訊號	切換模式
立體聲	NICAM(麗音)立體聲、NICAM(單聲道)
雙語	NICAM(麗音)頻道A、NICAM(麗音)頻道B、NICAM(麗音)頻道AB、NICAM單聲道
單聲道	NICAM(麗音)單聲道、單聲道

在 A2 電視廣播的電視模式下

訊號	切換模式
立體聲	立體聲、單聲道
雙語	頻道A、頻道B、頻道AB
單聲道	單聲道

- 在電視全屏播放電視節目時按下 **三** (選項表) 鍵，顯示功能表畫面。
- 按下 **▲/▼**，選擇“聲音設置-聲音切換”，然後按下 **OK**。
- 按下 **◀/▶**，按下 **OK** 來選擇所需的聲音。

註

- 僅在模擬電視(ATV)下可選擇聲音切換。

還原

將所有的音頻調校項目重新設定為出廠預設值。

頻道相關

頻道列表

顯示頻道資訊。

- 在電視全屏播放電視節目時按下 **三** (選項表) 鍵，顯示功能表畫面。
- 按下 **▲/▼**，選擇“頻道相關-頻道列表”，然後按下 **OK**。

頻道標籤

可更改各個頻道的名稱。

- 按下 **三** (選項表) 鍵，顯示功能表畫面。按下 **▲/▼**，選擇“頻道標籤”，按下 **OK**。
- 按下 **▲/▼/◀/▶** 選擇頻道，按下 **OK**。
- 按下 **▲/▼/◀/▶/OK** 選擇字元，直到名稱的字元全部拼出來，然後按下遙控器上的 **↶** (返回) 保存並且退出。

註

- 名稱的字元最多為6個。
- 只有ATV下的頻道可更改標籤。

觀看電視

■ 頻道排序

頻道位置可以自由地進行排序。

- 1 按下 **三** (選項表) 鍵，顯示功能表畫面。
按下 **▲/▼**，選擇“頻道排序”，按下 **OK**。
- 2 按下 **▲/▼/◀/▶**，選擇想移動的頻道，然後按下 **OK**。
- 3 按下 **▲/▼/◀/▶**，將該頻道移動到所需的位置，然後按下 **OK**。
- 4 重複上述操作直到完成所有頻道的排序。

■ 頻道跳越

在觀看電視節目時，如果用 **CH ▲/▼** (頻道 ▲/▼) 選擇了被設置為“跳越”的頻道，該頻道就會被直接跳過。

- 1 按下 **三** (選項表) 鍵，顯示功能表畫面。
按下 **▲/▼**，選擇“頻道跳越”，按下 **OK**。
- 2 按下 **▲/▼/◀/▶**，選擇需要跳越的頻道，按下 **OK**。
- 3 該頻道右上角會有選中的標記。
- 4 再次按下 **OK**，標記消失則取消跳越。

■ 頻道刪除

可以刪除各個頻道。

- 1 按下 **三** (選項表) 鍵，顯示功能表畫面。
按下 **▲/▼**，選擇“頻道刪除”，按下 **OK**。
- 2 按下 **▲/▼/◀/▶**，選擇頻道，然後按下 **OK**。
- 3 選擇“確定”，然後按下 **OK**，可刪除選擇的頻道。

■ 訊息

顯示節目資訊，僅適用於數碼電視。

- 1 在電視全屏播放電視節目時按下 **三** (選項表) 鍵，功能表畫面。
- 2 按下 **▲/▼**，選擇“頻道相關”，然後按下 **OK**。
- 3 按下 **▲/▼**，選擇“訊息”，按下 **OK**。

■ 節目指南

電子節目指南是與數碼電視 (DTV) 一起被廣播的。利用電子節目指南，您可查看數碼電視 (DTV) 的節目安排及其詳細資訊。

- 1 在電視全屏播放電視節目時按下 **三** (選項表) 鍵，顯示功能表畫面。
- 2 按下 **▲/▼**，選擇“頻道相關-節目指南”，然後按下 **OK**，可顯示電子節目指南

■ 註

· 節目指南顯示的時間為電視台發送的訊息。

■ 自動搜台

使用本選項表以便自動新增頻道服務。

■ 手動搜台

數碼電視選項下，可在指定頻寬或指定頻道號碼內新增頻道服務。

模擬電視選項下，可參考下表手動設置頻道項目。

所選擇的項目	說明
當前頻道	當前您想要手動調節的頻道。
彩色制式	選擇最佳的彩色制式接收。(PAL, SECAM, NTSC)。
聲音制式	選擇最佳的聲音制式 (廣播制式) 接收。(BG, DK, I, M)。
搜索	從當前頻道開始搜索，按照順序調整頻率搜尋下一個頻道。
微調	對當前的頻道進行頻率的微調優化。

■ 訊號強度

訊號強度是表示檢查天線相應訊號接收的狀態。

■ 音頻語言

當播放數碼電視 (DTV) 節目時可切換多種音頻語言。

- 1 在電視全屏播放電視節目時按下 **三** (選項表) 鍵，顯示功能表畫面。
- 2 按下 **▲/▼**，選擇“音頻語言”，然後按下 **OK**。
- 3 按下 **◀/▶** 來選擇所需的音軌，然後按下 **OK**。

■ 字幕語言

當廣播中含有字幕資訊時，您可以在此切換字幕語言。

- 1 在電視全屏播放電視節目時按下 **三** (選項表) 鍵，顯示功能表畫面。
- 2 按下 **▲/▼**，選擇“字幕語言”，然後按下 **OK**。
- 3 按下 **◀/▶** 來選擇所需的字幕語言，然後按下 **OK**。

■ 畫中畫

- 1 在電視全屏播放電視節目時按下 **三** (選項表) 鍵，顯示功能表畫面。
- 2 按下 **▲/▼**，選擇“畫中畫”，然後按下 **OK**。即可在屏幕保留當前畫面的情況下顯示其他畫面。當前畫面在電視機右上角顯示。
- 3 如果要退回全畫面顯示時，長按電視機遙控器上的 **◀**，選擇全螢幕，然後按 **OK** 鍵確認，即可回到全畫面顯示。

觀看電視

HDMI選項

HDMI設置

■ HDMI選擇

可供選擇的有：標準、增強。



- 只有在HDMI3信源下才能進行HDMI選擇。

■ 電腦顯示模式

可供選擇的有：開啟、關閉。

■ 連動設定

可供選擇的有：開啟、關閉。

該功能可提供HDMI所連接設備與電視機保持連動性。

TV設置

可根據您的需求設置選項表。

基本設置



開機狀態

設置開機狀態。兩種狀態可供選擇：電視或智能界面。



- “電視”：開機後進入電視界面。
- “智能界面”：開機後進入智能界面。

定時關機

在指定的時間自動關閉電視機。

可選擇的有：“關”、“30 分鐘”、“60 分鐘”、“90 分鐘”、“120 分鐘”、“150 分鐘”或“自定義”。



- 在設定了時間後，倒計時自動開始。
- 在到達預設時間之前 5 分鐘開始，每分鐘會顯示一次剩餘時間。

待機指示燈

您可以對待機指示燈進行設置

可供選擇的有：“開啟”或“關閉”。

語言設置

您可以設置系統的語言。

三種語言可供選擇：繁體中文、簡體中文或英文。

更多設置

■ 預設輸入法

輸入法的設定。



- 電視機初始安裝“IQQI-International”。
- 對於非本機初始安裝的輸入法，不保證其與電視系統的兼容性。

■ 極速啟動

可供選擇的有：關閉、極速啟動。

■ 無訊號自動關機

可將電視機設定為在接收不到節目的訊號後約 15 分鐘時自動關閉電源。



- 在電源關閉之前的 5 分鐘，每隔一分鐘會顯示一次剩餘時間。

■ 按鍵音

可供選擇的有：開啟、關閉。

■ 畫中畫尺寸

可供選擇的有：大、中、小。

■ 數碼音頻語言

設置首選多音頻語言，在提供音頻語言時播放。



- 本功能視乎電視台的音頻語言資訊而定。
- 若接收到的廣播訊號中不包含所選語言的音頻，那麼就不會輸出該語言的音頻。

■ 字幕

當廣播中含有字幕資訊時，可以在此設置。



- 若接收到的廣播訊號中不包含所選語言的字幕，該語言的字幕是不會顯示出來。

網絡

請參閱第 24 頁和第 25 頁。

應用

請參閱第 26 頁。

觀看電視

系統

查看和設置系統相關的訊息。

系統訊息

查看系統的硬件訊息和軟件訊息。

法律訊息

查看開放源代碼許可訊息。

本地升級

利用此功能可透過 USB 設備將軟件更新到最新版本。

註

- 若數據與系統不相容，則畫面上會出現一個錯誤訊息。按下 **OK** 之後，請重複進入一般設置→系統→本地更新進行操作。
- 若顯示出錯誤訊息，則請檢查：
 - USB 設備是否已可靠地插入。
 - USB 設備中有 2 個或更多的軟件更新文件。
 - USB 存儲器中沒有用於更新系統的數據。
 - 軟件更新文件已損壞。
 - 軟件更新文件與電視機的軟件不兼容。
- 更新時，請不要切斷電視機電源或進行其他操作。

系統還原

如果經過了複雜的調校之後，設置不能夠恢復到正常狀態，那麼請將設置還原到出廠時的預設值。

網絡功能

連接到網絡

想要享受互聯網服務，那麼就需要用高速連接到互聯網的方式將電視機連接到路由器。

註

- 如果不具備寬頻互聯網連接條件，那麼請諮詢您購買電視機的商店或詢問您的互聯網服務供應商或電話公司。
- 播放串流媒體內容需要有穩定的連接速度，否則可能無法正常觀看。

無線安裝準備

開啟路由器（市面有售）電源，如下圖所示用無線方式將電視機連接到您的路由器。

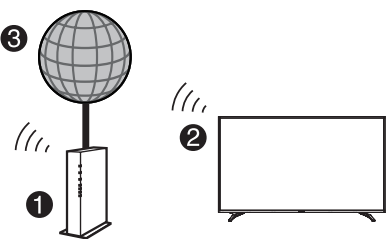

- 1 無線區域網路路由器 / 接入點
- 2 電視機
- 3 網絡

有線安裝準備

開啟路由器（市面有售）電源，如下圖所示用LAN接線（市面有售）將電視機上的LAN端子連接到您的路由器。

- 路由器的使用方法請參閱其使用說明書。

有線連接概覽圖

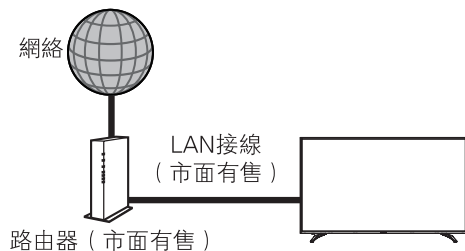

如何連接







註

- 本電視機具有以下認證。
 - Wi-Fi CERTIFIED™ (Wi-Fi 聯盟的認證手續)
- 並非在所有的居住環境下都能保證有無線區域網連接並保證其性能。在以下情況下，無線區域網信號可能很差或衰落，或其連接速度可能變得較慢。
 - 在混凝土、有加固鋼筋、或金屬結構的建築物中使用時
 - 放置在能阻隔信號的物體附近時
 - 在與其他輻射相同頻率的無線設備一起使用時
 - 在微波爐和其他輻射磁場、靜電或電磁干擾的設備附近使用時
- 請確認您的網絡中的防火牆允許訪問到電視機的無線連接。
- 當使用未經 Wi-Fi® 認證的接入點時，不能保證可正常運行。
- 在使用無線區域網時，需要有一個無線區域網接入點來將電視機連接到互聯網。設置方法請參閱您的接入點的使用說明書。
- 播放串流媒體內容需要穩定的連接速度。如果無線區域網的速度不穩定，那麼請使用有線連接。
- 由於網絡上格式眾多，某些格式本電視機可能無法播放。
- 在轉換到第三方或更改配置之前，請務必先進行無線區域網設置的初始化。

網絡功能

網絡設置

按下 ，顯示主頁智能界面，按下 ///，選擇“TV設置”選項，然後按下OK（輸入），顯示設置界面。

無線網絡

使用無線連接方式接入到網絡。

將“Wi-Fi”設置為打開之後，螢幕顯示當前附近的無線網絡訊息。

如當前無線網絡連接安全性為不開放，按下 **OK**，調出輸入法後輸入密碼。

■ 添加網絡

您可以手動添加一個不廣播的無線網絡。

根據螢幕提示輸入不廣播的無線網絡資訊後選擇“儲存”，即可添加當前無線網絡。

有線網絡

使用有線連接方式接入到網絡。

將“有線網絡連接”設置為打開之後，螢幕顯示當前有線網絡訊息。

■ 有線網絡連接

根據頁面提示輸入對應的IP地址、子網絡遮罩、網關、首選DNS服務器、備用DNS服務器。

■ 自動連接

系統會嘗試自動獲取IP位址等相關資訊。

藍牙

選擇“藍牙”並按下**OK**，顯示正在掃描設備。

可在此選擇重新整理。

連接藍牙設備的具體操作請參閱螢幕提示進行。



- 視乎使用的設備而定，藍牙設備可能無法正常運作。

我的設備名

設立本電視機的名稱。

可供選擇的有：我的SHARP電視（012345）、主臥、次臥、客廳、書房、辦公室、自定義。

網絡訊息

查看網絡連接相關信息。

智能功能

智能電視搭載安卓平台。按下 ，顯示主頁智能界面。

智能界面

智能界面將電視節目、應用程式等整合其中，為您呈現最直接方便的智能操作界面。



您可以在該智能界面自由切換，按下 **OK** 進入具體內容。

您可以選擇信源（模擬電視、數碼電視、HDMI1、HDMI2、HDMI3、AV、色差），然後按下遙控器上的 **OK** 進入。

您也可以直接體驗隨機安裝的應用，也可以從應用商店下載更多的應用。

但無法保證所有應用軟體能夠正確讀取產品資訊。

安裝應用

進入“應用商店”，選擇您想安裝的應用，根據螢幕提示將應用安裝到電視上。

應用

存儲空間

可查看電視內部未使用和總存儲空間。

允許未知來源

設置是否允許未知安全來源的應用。

應用管理

■ 已下載應用

查看已下載應用程序的信息。

您可管理已經下載到電視的應用。

■ 系統應用

查看系統應用程序的信息。

SD卡格式化

格式化 Micro SD 卡槽中的存儲卡。

🔗 註

- 選擇 SD 卡格式化將導致當前存儲或安裝在 Micro SD 卡上的內容被完全刪除，已經刪除的內容或應用不可恢復，請謹慎操作。

SD卡安全卸載

請在拔出 Micro SD 卡槽中的存儲卡之前，進行安全卸載操作。

🔗 註

- 記憶卡不得執行熱插拔操作，否則可能會令電視機故障。
- 記憶卡需要在安全移除或關閉電視機後才可取下。
- 請時常為記憶卡內的資料備份，防止資料損壞或電視機運作錯誤。（若有任何儲存資料損壞或遺失，SHARP 不負責）

瀏覽器

在智能界面，選擇“瀏覽器”，然後按下 **OK** 即可進入。您也可以按下遙控器上的 **Q**（**瀏覽器**），快速進入瀏覽器界面。初次使用請先安裝瀏覽器。

其他有用功能

可將 USB 存儲設備或 USB 硬碟驅動器連接到電視機來觀賞相片、聆聽音樂並觀看影片。

註

- 由於 USB 存儲設備各有不同，電視機可能不能夠識別所記錄的數據。
- 如果 USB 存儲設備中存儲了許多文件或文件夾，那麼讀取所記錄的數據可能需要花費相當長的時間。
- 有可能不支援某些視頻文件中的外掛字幕。

連接 USB 存儲設備

將記錄著相片、音樂或影片的 USB 存儲設備插入到電視機上的 USB1 或 USB2 端子。

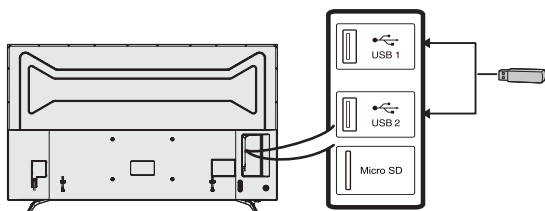









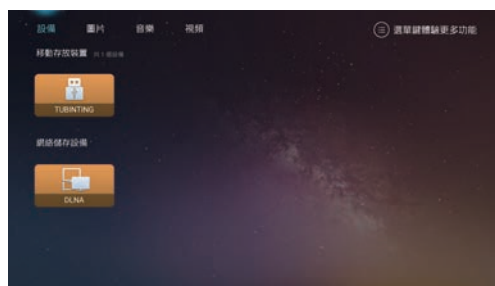



- USB1 和 USB2 端子不可同時連接硬碟驅動器。
- 在連接 USB 硬碟驅動器時，請務必使用具有交流電源適配器的硬碟驅動器。
- 正在傳輸文件時，請勿從電視機上卸下存儲設備。
- 請勿將 USB 存儲設備 /USB 硬碟驅動器反覆插入和從電視機上拔出。
- 在使用讀卡器時，請務必在使用讀卡器之前先插入存儲卡。
- 電視機可能會無法識別讀卡器。
- 當電視正在播放 USB 設備中的數據時，請遵守以下事項：
 - 請勿關閉電視機。
 - 請勿斷開 USB 電線連接。
 - 請勿拔出、移動 USB 設備，如需拔出請先退出 USB 界面，否則可能造成數據丟失，USB 設備損壞或電視系統故障無法正常運行。
- 當連接 USB 集線器時，電視機可能不能夠識別所有的 USB 存儲設備。

注意

- 請勿使用 USB 延長連接線將 USB 存儲設備連接到電視機的 USB 端子上，否則可能會妨礙電視機正常工作。
- 請打開電視機後再插入 USB 存儲設備。

播放 USB 存儲設備中的檔案



- 1 按下遙控器上的  進入智能界面，選擇“媒體庫”，然後按下 **OK** 進入。
- 2 按下  /  /  / ，選擇您要進入的設備或驅動器。
- 3 按下  /  /  / ，選擇所需的文件、相片、音樂或影片，然後按下 **OK**。選擇您想要播放的文件，然後按下 **OK**，即可播放當前文件。
 - 按下遙控器上的  (**返回**) 鍵，可以進入上一層文件夾。
- 4 觀看相片、影片時按 **三 (選項表)** 可顯示 USB 多媒體選項表畫面。通過按  /  選擇相關功能，然後按 **OK** 進行操作。詳細功能與其適用的模式請參閱第 28 頁的表格。

其他有用功能

用於USB多媒體選項表操作的按鈕

按鈕/選項表	說明	影片模式	音樂模式	相片模式
	播放/ 暫停。	✓	✓	-
	循環播放所有。	-	✓	-
	順序播放。	-	✓	-
	隨機播放。	-	✓	-
	單曲播放。	-	✓	-
	單曲循環。	-	✓	-
	播放列表。 顯示播放列表，可以從播放列表中選擇播放文件。	✓	✓	-
 縮放	按CH^/V切換相片大小，按▲/▼/◀/▶鍵移動。	-	-	✓
 旋轉	旋轉相片 按◀逆時針旋轉；按▶順時針旋轉； 按↶ 返回 鍵退出。	-	-	✓
 幻燈片	幻燈片播放選項 選擇幻燈片播放時的間隔時間、切換模式。	-	-	✓
 字幕設置	視頻播放時設置字幕 可進行字幕顯示、字幕切換、高級設置。	✓	-	-
 音軌調節	視頻播放時選擇音軌。	✓	-	-
 播放設置	設置單部迴圈、斷點播放。	✓	-	-
 時間跳轉	指定播放起點 從輸入的時間開始播放。	✓	-	-
 ◀	按OK鍵播放上一個文件。	✓	✓	-
 ▶	按OK鍵播放下一個文件。	✓	✓	-
 ⏩	按OK鍵快進。	✓	-	-
 ⏪	按OK鍵快退。	✓	-	-
 ◀	播放上一個文件。	-	-	✓
 ▶	播放下一個文件。	-	-	✓
 ⌚	定時退出。	-	✓	-
 ⌂	即可在屏幕保留當前畫面的情況下顯示其他畫面。	✓	-	-
 ⏻	按◀/▶選擇確認或取消，選擇確認後屏幕關閉，按除了電源鍵和音量鍵以外的任意鍵可再次打開屏幕。	-	✓	-

與 USB 模式相容的檔案列表

■ 支援的視頻格式

文件擴展名	解碼格式
.3gp	H.263 H.264 HP@Up to Level 4.1 H.264(AVC) BP@L4.0 H.264(AVC) MP@L4.0
.avi	H.264 MP@L 4.0 H.264 HP LV 5.1 H.264 HP@Up to Level 4.1 H.264 (AVC) MP@L 4.1 MPEG2 MP@HL
.flv	H.264 BP LV 4.0 H.264 HP@Up to Level 4.1 H.264(AVC) MP@L4.1
.m2ts	MPEG2 MP@HL H.265(HEVC) MP / Main 10 Profile @ Up to Level 5.1
.mkv	H.264 HP@Up to Level 4.1 H.264 (AVC) MP@L 4.1 H.265(HEVC) MP / Main 10 Profile @ Up to Level 5.1
.mov/m4v	H.264 HP@Up to Level 5.1 M-JPEG
.mp4	H.264 HP@Up to Level 5.1 H.264(AVC) BP@L4.0 H.264(AVC) MP@L4.0 MPEG4 SP, MPEG4 ASP@Level 5 MPEG4 SP@HL 3.0 & MPEG4 ASP@HL 4.0 H.265(HEVC) MP / Main 10 Profile @ Up to Level 5.1
.mpg/vob/mpeg	MPEG1 MP@HL MPEG2 MP@HL
.rmvb	Real Video 9
.trp/tp	MPEG2 MP@HL
.ts	H.264 BP@Up to Level 4.0 H.264 HP@Up to Level 5.1 H.264(AVC) BP@L3.1 H.264(AVC) MP@L4.1 MPEG2 MP@HL H.265(HEVC) Main / Main-10 Profile @ Up to Level 5.1
.webm	VP8

■ 支援的圖片格式

文件擴展名	圖片編碼
JPEG	progressive 4000*4000 baseline 8000*8000
PNG	4096*5760
GIF	8000*8000
BMP	8000*8000

■ 支援的音頻格式

文件擴展名	解碼格式
.3gp	AMR-NB
.aac	AAC
.avi	AAC Dolby AC3 MP3 PCM WMA
.flac	FLAC
.m2ts	AAC Dolby AC3
.mid	MIDI
.mka	Dolby AC3
.mkv	AAC Dolby AC3 DTS
.mp3	MPEG1 Layer1/2/3
.mp4	AAC Dolby E-AC3 MPEG4(AAC)
.ogg	VORBIS
.ts	AAC Dolby E-AC3 DTS MP3 MPEG Audio
.wav	PCM
.webm	WMA V9

■ 字幕文件格式

ASS MicroDVD
SRT SSA
Subview Vobsub

註

- 視頻文件需同時滿足上述的視頻格式和音頻格式，才能正常播放。
- USB 1.1設備中的文件可能無法正確播放。
- 不保證可以使用USB集線器。
- 可能無法正確播放高於 1280x720 的 Motion jpeg視頻。
- 上述列表中某些文件格式可能無法正常播放（包括圖像、聲音、字幕等）。
- 視比特率而定，某些文件可能無法播放。
- 支援的是 DTS 編碼的視頻文件，並不是 DTS 環繞聲。
- 某些字幕可能無法正確顯示，並可能影響電視機的正常運作。
- 僅顯示相容的文件格式。
- 根據文件不同，顯示的播放時間可能會與實際播放時間稍有不同。
- 部分文件時間長度資訊可能無法正確顯示。

附錄

故障分析

下述問題並非一定由於故障而引起。在請人修理電視機之前，請再次檢查電視機。

故障	可能的解決方案
<ul style="list-style-type: none">沒有電源。	<ul style="list-style-type: none">交流電源線是否沒有連接？（請參閱第 14 頁。）主電源是否被開啟？（請參閱第 18 頁。）若電源開關不起作用，請拔出電源插頭然後再將電源插頭插入，等待 5 秒鐘以上，然後再按下電視機上的 ⏻ (POWER)。
<ul style="list-style-type: none">不能操作本機。	<ul style="list-style-type: none">外來的影響，例如閃電、靜電等等，都可能導致不能正常運行。在這種情況下，請先關閉電視機的電源，或拔出交流電源線並等待 1 到 2 分鐘之後再重新插入，然後再操作電視機。
<ul style="list-style-type: none">遙控器不起作用。	<ul style="list-style-type: none">電池是否按極性 (+、-) 對齊了裝入？（請參閱第 17 頁。）電池是否已經電量耗盡？（更換新的電池。）
<ul style="list-style-type: none">畫面被切斷。	<ul style="list-style-type: none">螢幕模式調校（例如影像尺寸）是否正確？（請參閱第 19 頁。）
<ul style="list-style-type: none">奇怪的顏色、色彩淺淡、色調昏暗、或色彩不能對準。	<ul style="list-style-type: none">調校影像色調。（請參閱第 19 頁。）房間是否太亮？在特別明亮的房間裏畫面可能看起來比較暗淡。檢查彩色制式的設置。（請參閱第 21 頁。）
<ul style="list-style-type: none">電源突然關閉。	<ul style="list-style-type: none">機器內部的溫度升高。 移開擋住通風口的物體，或是清潔通風口。是否設置了定時關機、無訊號自動關機？（請參閱第 22 頁。）
<ul style="list-style-type: none">沒有影像。	<ul style="list-style-type: none">與其外部設備之間的連接是否正確？（請參閱第 15 頁、第 16 頁和第 27 頁。）是否選擇了正確的輸入？（請參閱第 26 頁。）影像調整是否正確？（請參閱第 19 頁。）天線是否正確地連接好了？（請參閱第 14 頁。）檢查彩色制式的設置。（請參閱第 21 頁。）
<ul style="list-style-type: none">沒有聲音。	<ul style="list-style-type: none">音量是否太低？（請參閱第 13 頁。）檢查聲音制式的設置。（請參閱第 21 頁。）
<ul style="list-style-type: none">電視機有時會發出破裂聲。	<ul style="list-style-type: none">這並非故障。由於溫度變化，機殼會有輕微的熱脹冷縮，此時可能發出聲響。這並不影響電視機的性能。
<ul style="list-style-type: none">無法選擇想要的頻道。	<ul style="list-style-type: none">切換數碼電視和模擬電視模式。（請參閱第 26 頁。）
<ul style="list-style-type: none">無法連接網絡。	<ul style="list-style-type: none">LAN 連線是否正確連接。（請參閱第 24 頁和第 25 頁。）請確認“網絡設置”的設定。

在高溫和低溫環境下使用的注意事項

- 當機器在低溫空間使用時（例如房間、辦公室），影像可能會出現拖尾或是出現少許延遲。這並不是故障，當溫度恢復正常時，本機的顯示也會恢復正常。
- 勿將本機置於很熱或很冷的地方。也不要將本機置於受到陽光直接照射或接近熱源的地方，否則可能會引致外殼變形，並導致液晶顯示屏發生故障。
儲藏溫度為 -20°C 至 $+60^{\circ}\text{C}$ 。

附錄

規格

項目		型號	4T-C60AM1H	4T-C70AM1H
解像度			8,294,400 像素 (3840(H) X 2160(V))	
視頻彩色制式			PAL / SECAM / NTSC 3.58 / NTSC 4.43 / PAL 60	
電視標準	電視制式	模擬	PAL:BG, DK, I SECAM:BG, DK NTSC:M	
		數碼	DTMB	
	接收頻道	VHF/ UHF	44.25MHz-863.25MHz	
		CATV	S1-S41頻道 (包括超頻段)	
	數碼地面廣播	52.50MHz-866.00MHz		
立體聲 / 雙語	麗音 : BG, I, DK A2 立體聲 BG			
電視調諧系統	模擬	自動預設 99 個頻道		
	數碼	自動預設 999 個頻道		
音頻輸出功率			10W x 2(左/右揚聲器)	
揚聲器			Φ60mm x 2	
端子	側面	USB1	USB 2.0	
		USB2	USB 3.0	
		Micro SD	Micro SD存儲卡	
		HDMI 1	HDMI(HDMI輸入) (480i, 576i, 480p, 576p, 720p/50Hz, 720p/60Hz, 1080i/50Hz, 1080i/60Hz, 1080p/50Hz, 1080p/60Hz, 1080p/24Hz, 2160p/30Hz), (支持Dolby Vision格式訊號)	
		HDMI 2 (ARC)	HDMI(HDMI輸入) (480i, 576i, 480p, 576p, 720p/50Hz, 720p/60Hz, 1080i/50Hz, 1080i/60Hz, 1080p/50Hz, 1080p/60Hz, 1080p/24Hz, 2160p/30Hz), (支持Dolby Vision格式訊號)	
		HDMI 3	HDMI(HDMI輸入) (480i, 576i, 480p, 576p, 720p/50Hz, 720p/60Hz, 1080i/50Hz, 1080i/60Hz, 1080p/50Hz, 1080p/60Hz, 1080p/24Hz, 2160p/30Hz, 2160p/60Hz), (僅 HDMI3 端子支援HDR10訊號, 支持Dolby Vision格式訊號)	
	後面	天線	UHF/VHF75 Ω DIN 型插座	
		數碼音頻輸出	光纖數碼音頻輸出	
		色差 / 影音輸入	色差輸入 (480i, 576i, 480p, 576p, 720p/50Hz, 720p/60Hz, 1080i/50Hz, 1080i/60Hz), 音頻輸入; 視頻輸入, 音頻輸入	
		服務專用端子	僅用於服務	
		LAN (區域網絡)	網絡插座	
屏幕顯示的語言			英文 / 中文 (簡體) / 中文 (繁體)	
電源要求			交流 220V, 50Hz	
整機消耗功率 (備用)			215W (0.5W)	250W (0.5W)
重量	不包括底座		23.0 kg	35.5 kg
	包括底座		24.0 kg	36.5 kg
操作溫度			0 °C 至 +45 °C	
• 作為不斷改進產品性能的方針之一, SHARP 公司保留為改進產品而改變設計與規格不需事先通知的權利。				

附錄

輪廓圖

4T-C60AM1H

單位：毫米

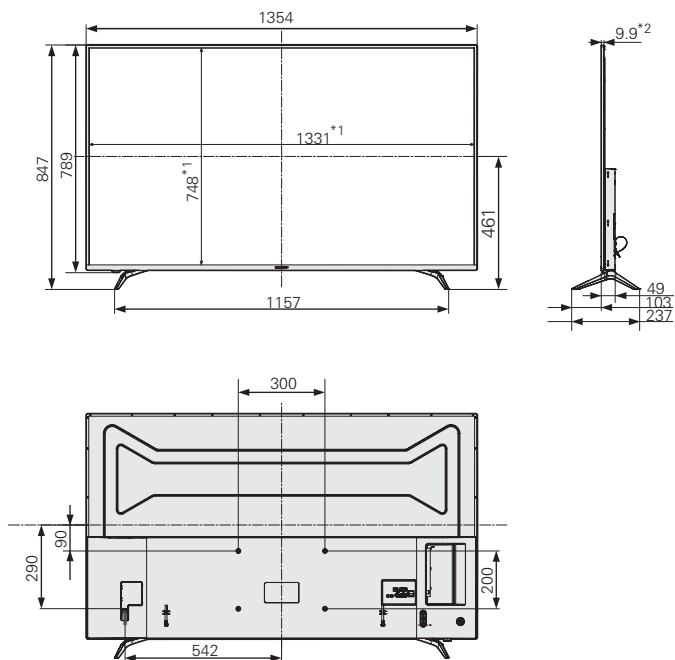

4T-C70AM1H

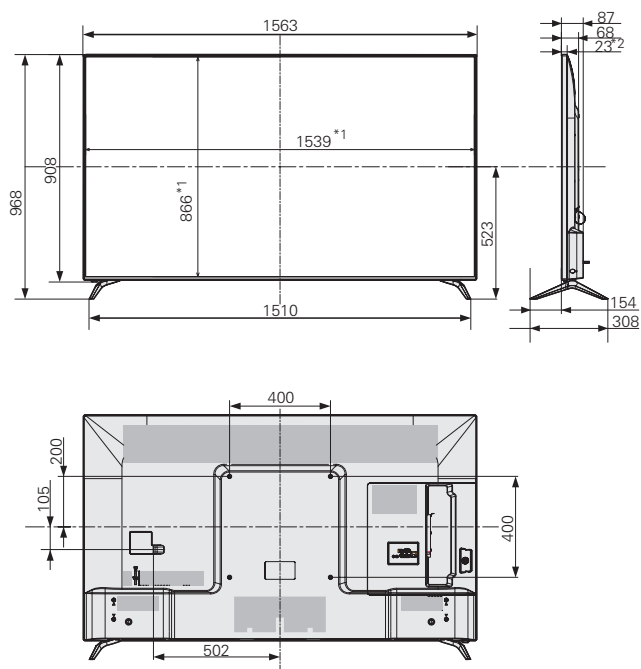

*1 有效區域
*2 最薄的部份

OPERATION MANUAL

Dear SHARP customer

Thank you for your purchase of the SHARP LCD colour TV product. To ensure safety and many years of trouble-free operation of your product, please read the Important Safety Precautions carefully before using this product.

Contents

Introduction

Dear SHARP customer	1
Contents	1
Precautions for daily use	3
Important safety precautions	4
Trademarks	5
Disclaimers	6
Accessories	7

Preparation

Attaching the stand unit	8
How to make a simple platform (For 4T-C70AM1H only)	9
Handling and precautions with the wall-mounted TV	10
Part names	10
TV (Front)	10
TV (Rear)	11
Remote control unit	12
The operation button	13
Remote control pairing	13
Before turning on the power	14
Connecting external devices	15
Using digital audio output	16
Inserting a Micro SD memory card	16
Connecting a USB memory device	16
Connecting to the Network	16
Inserting the batteries	17
Cautions regarding the remote control unit	17
Turning the TV on/off	18
Running the TV for the first time	18
Turning off the TV	18
User Guide	18

Watching TV

Menu	19
Numeric keypad	19
Video	19
Picture mode	19
Contrast/Brightness/Tint/Sharpness/Colour/Backlight	19
Audio only	19
Wide mode	19
Advanced	19
Gamma setting	19
Colour temp (Colour temperature)	19
DNR	19
Active contrast	19
Fine Motion	19
Intelligent variable contrast	19
HDR Gamma setting	19
Reset	20
Audio	20
Audio mode	20
Auto volume	20
Bass/Treble/Balance	20
Surround sound	20
Digital audio output	20
MPX	20
Reset	20
Channel setting	20
Program list	20

Contents

Watching TV (Continued)

Label	20
Sort	21
Skip	21
Delete	21
Info	21
EPG	21
Auto search	21
Manual search	21
Signal strength	21
Audio language	21
Subtitle language	21
PinP	22
HDMI menu.....	22
HDMI setting	22
HDMI select	22
PC mode	22
HDMI CEC	22
TV setup.....	22
General	22
Booting state	22
Sleep timer	22
Standby indicator	22
Language	22
Advanced.....	22
Default input method	22
Super quick	22
No signal power off	22
Keypad sound.....	22
PinP size	22
Digital audio language	22
Subtitle	22
Network	22
Apps	23
System	23
System info	23
Legal info.....	23
Local update	23
System recovery	23

Network function

Connecting to the Network.....	24
Wired installation	24
Wireless installation	24
Network setting	25
Wireless network connection	25
Ethernet network connection	25
Bluetooth ®.....	25
Device name	25
Network info.....	25

Smart function

Smart home	26
Installing Apps.....	26
Apps.....	26
Storage	26
Install.....	26
Apps.....	26
Format Micro SD card	26
Safely Remove Micro SD card	26
Browser.....	26

Other useful features

Connecting a USB memory device	27
Playing back files on a USB memory device	27
Buttons for USB media operation	28
List of file formats compatible with USB mode	29

Appedix

Troubleshooting	30
Specifications	31
Dimensional drawings.....	32

Precautions for daily use

Observe the following items

Maintenance of the cabinet

- When cleaning the cabinet, use a soft cloth (made of cotton, floss, etc.) to clean gently.
Do not use a dry or damp rag mixed with chemicals, as this could cause the ingredients of the cabinet body to deteriorate or crack.
- Be careful not to use an abrasive cloth for cleaning or clean with excessive force, as this could scratch the surface of the cabinet.
- If the cabinet is greatly soiled, clean with a soft cloth (made of cotton, floss, etc.) soaked with a small amount of diluted neutral detergent and wrung out, and then clean with a soft dry cloth.
- Because the cabinet is made of plastic, solvents such as benzene, alcohol or thinner could cause it to deteriorate, or make its coating come off. Therefore do not use such solvents to clean the cabinet.
- Because plasticizer is included in the plastics, deterioration or the coating peeling off could occur when the cabinet comes into contact with some substances. Therefore keep it away from volatile substances such as insecticide. In addition, do not let it come into contact with objects made of rubber, resin, etc. for a long time.

Maintenance of the LCD panel

- Before cleaning the LCD panel, be sure to turn off the TV set and unplug the power cord from the outlet.
- When cleaning the LCD panel, use a dry and soft cloth (made of cotton, floss, etc.) to clean the surface of the LCD panel gently. For protecting the LCD panel, do not clean with a dirty cloth, detergent, or a dry or damp rag mixed with chemicals, as this could cause peeling of the panel surface.
- Be careful not to clean with an abrasive cloth or with excessive force, as this could cause the panel surface to be scratched.
- If the LCD panel is greatly soiled, clean it gently with a soft cloth (made of cotton, floss, etc.) soaked with a small amount of water (Do not clean with excessive force, so as to avoid the scratch of the panel surface).
- If dust sticks on the surface of the LCD panel, clean the panel with a commercially available cleaning brush (anti-static brush).

Important safety precautions

- **Cleaning** — Unplug the AC cord from the AC outlet before cleaning the product. Use a damp cloth to clean the product. Do not use alcohol cleaners, spray cleaners or chemical cloth when cleaning because these types of materials may damage the product.

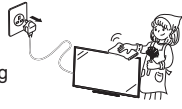

- **Water and moisture** — Do not use the product near water, such as bathtub, washbasin, kitchen sink, laundry tub, swimming pool and in a wet basement.



- Do not place vases or any other water-filled containers on this product. Do not place the product under air conditioner, humidifier and so on. The water may spill onto the product causing fire or electric shock.



- **Stand** — Do not place the product on an unstable cart, stand, tripod or table. Doing so can cause the product to fall, resulting in serious personal injuries as well as damage to the product. Use only a cart, stand, tripod, bracket or table recommended by the manufacturer or sold with the product. When mounting the product on a wall, be sure to follow the manufacturer's instructions. Use only the mounting hardware recommended by the manufacturer.



- When relocating the product placed on a cart, it must be moved with utmost care. Sudden stops, excessive force and uneven floor surface can cause the product to fall from the cart.



- **Ventilation** — The vents and other openings in the cabinet are designed for ventilation. Do not cover or block these vents and openings since insufficient ventilation can cause overheating and/or shorten the life of the product. Do not place the product on a bed, sofa, rug or other similar surface, since they can block ventilation openings. This product is not designed for built-in installation; do not place the product in an enclosed place such as a bookcase or rack, unless proper ventilation is provided or the manufacturer's instructions are followed.

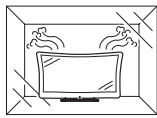

- In case the product is dropped and the cabinet is damaged, be sure to turn off the power of the product, and unplug the power cord. If you continue to use the product, it may cause fire or electric shock.



- Do not open the rear cover of the cabinet to reconstruct the circuits. There exists high voltage within the cabinet and it may cause electric shock and injury. If maintenance is required, contact your dealer.



- The LCD panel used in this product is made of glass. Therefore, it can break when the product is struck forcefully or with a sharp object. If the LCD panel is broken, be careful not to be injured by broken glass.



- **Heat sources** — Keep the product away from heat sources such as radiators, heaters, stoves and other heat-generating products (including amplifiers)

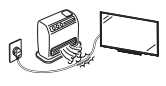

- To prevent fire never place any type of candle or naked flames on the top or near the TV set.



- To prevent fire or shock hazard, do not place the AC power cord under the TV set or other heavy items.

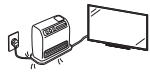

- Do not place heavy objects on this product or stand on it. Doing so could cause injury if the product overturns. Take special care near children and pets.



- Unplug the power cord before you move the TV set. If not unplugged beforehand, the power cord may become damaged and cause electric shock.

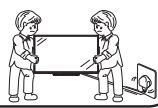

The LCD panel is a very high technology product with 8,294,400 pixels, giving you fine picture details. Due to the very large number of pixels, occasionally a few non-active pixels may appear on the screen as a fixed point of blue, green or red. This is within product specifications and does not constitute a fault.

Precautions when transporting the TV

- When transporting the TV, never carry it by holding or otherwise putting pressure onto the display. Be sure to always carry the TV by at least two people holding it with two hands — one hand on each side of the TV.

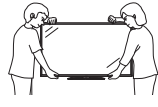

- Do not display a still picture for a long time, as this could cause an afterimage to remain.

- Install the product on the place where the AC cord can be unplugged easily from the AC outlet.

NOTE

• The above are pictures for reference only; the actual item might be different.

Trademarks

- Dolby, Dolby Audio, Dolby Vision, and the double-D symbol are trademarks of Dolby Laboratories. Manufactured under license from Dolby Laboratories. Confidential unpublished works. Copyright 1992-2015 Dolby Laboratories. All rights reserved.
- The terms HDMI and HDMI High-Definition Multimedia Interface, and the HDMI Logo are trademarks or registered trademarks of HDMI Licensing Administrator, Inc. in the United States and other countries.
- For DTS patents, see <http://patents.dts.com>. Manufactured under license from DTS Licensing Limited. DTS, the Symbol, DTS and the Symbol together, Digital Surround, and the DTS 2.0+Digital Out logo, are registered trademarks and/or trademarks of DTS, Inc. in the United States and/or other countries. © DTS, Inc. All Rights Reserved.
- The Wi-Fi CERTIFIED Logo is a certification mark of the Wi-Fi Alliance.
- SDHC logo is a trademark of SD-3C,LLC.
- MPEG Layer-3 audio coding technology licensed from Fraunhofer IIS and Thomson.
- THIS PRODUCT IS LICENSED UNDER THE AVC PATENT PORTFOLIO LICENSE FOR THE PERSONAL USE OF A CONSUMER OR OTHER USES IN WHICH IT DOES NOT RECEIVE REMUNERATION TO (i) ENCODE VIDEO IN COMPLIANCE WITH THE AVC STANDARD ("AVC VIDEO") AND/OR (ii) DECODE AVC VIDEO THAT WAS ENCODED BY A CONSUMER ENGAGED IN A PERSONAL ACTIVITY AND/OR WAS OBTAINED FROM A VIDEO PROVIDER LICENSED TO PROVIDE AVC VIDEO. NO LICENSE IS GRANTED OR SHALL BE IMPLIED FOR ANY OTHER USE. ADDITIONAL INFORMATION MAY BE OBTAINED FROM MPEG LA, L.L.C. SEE [HTTP://WWW.MPEGLA.COM](http://WWW.MPEGLA.COM)
- THIS PRODUCT IS LICENSED UNDER THE MPEG-4 VISUAL PATENT PORTFOLIO LICENSE FOR THE PERSONAL AND NON-COMMERCIAL USE OF A CONSUMER FOR (i) ENCODING VIDEO IN COMPLIANCE WITH THE MPEG-4 VISUAL STANDARD ("MPEG-4 VIDEO") AND/OR (ii) DECODING MPEG-4 VIDEO THAT WAS ENCODED BY A CONSUMER ENGAGED IN A PERSONAL AND NON-COMMERCIAL ACTIVITY AND/OR WAS OBTAINED FROM A VIDEO PROVIDER LICENSED BY MPEG LA TO PROVIDE MPEG-4 VIDEO. NO LICENSE IS GRANTED OR SHALL BE IMPLIED FOR ANY OTHER USE. ADDITIONAL INFORMATION INCLUDING THAT RELATING TO PROMOTIONAL, INTERNAL AND COMMERCIAL USES AND LICENSING MAY BE OBTAINED FROM MPEG LA, L.L.C. SEE [HTTP://WWW.MPEGLA.COM](http://WWW.MPEGLA.COM)
- The Bluetooth® word mark and logos are registered trademarks owned by Bluetooth SIG, Inc. and any use of such marks by SHARP Corporation is under license. Other trademarks and trade names are those of their respective owners.
- This product is protected by certain intellectual property rights of Microsoft. Use or distribution of such technology outside of this product is prohibited without a license from Microsoft.







Disclaimers

- This SHARP device facilitates the access to content and services provided by third parties. The content and services accessible via this device belong to and may be proprietary to third parties. Therefore, any use of such third party content and services must be in accordance with any authorization or terms of use provided by such content or service provider. SHARP shall not be liable to you or any third party for your failure to abide by such authorization or terms of use. Unless otherwise specifically authorized by the applicable content or service provider, all third party content and services provided are for personal and non-commercial use; you may not modify, copy, distribute, transmit, display, perform, reproduce, upload, publish, license, create derivative works from, transfer or sell in any manner or medium any content or services available via this device.
 - SHARP is not responsible, nor liable, for customer service-related issues related to the third party content or services. Any questions, comments or service-related inquiries relating to the third party content or service should be made directly to the applicable content or service provider.
 - You may not be able to access content or services from the device for a variety of reasons which may be unrelated to the device itself, including, but not limited to, power failure, other Internet connection, or failure to configure your device properly. SHARP, its directors, officers employees, agents, contractors and affiliates shall not be liable to you or any third party with respect to such failures or maintenance outages, regardless of cause or whether or not it could have been avoided.
 - All third party content or services accessible via this device is provided to you on an “as-is” and “as available” basis and SHARP and its affiliates make no warranty or representation of any kind to you, either express or implied, including, without limitation, any warranties of merchantability, non-infringement, fitness for a particular purpose or any warranties of suitability, availability, accuracy, completeness, security, title, usefulness, lack of negligence or error-free or uninterrupted operation or use of the content or services provided to you or that the content or services will meet your requirements or expectations.
 - SHARP is not an agent of and assumes no responsibility for the acts or omissions of third party content or service providers, nor any aspect of the content or service related to such third party providers.
 - In no event will SHARP and/or its affiliates be liable to you or any third party for any direct, indirect, special, incidental, punitive, consequential or other damages, whether the theory of liability is based on contract, tort, negligence, breach of warranty, strict liability or otherwise and whether or not SHARP and/or its affiliates have been advised of the possibility of such damages.
-
- The operation manual has been collated and checked strictly. Due to factors such as software upgrading, SHARP can not guarantee that the actual operation keeps pace with the manual description.

Accessories

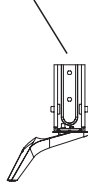
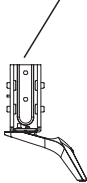
Supplied accessories

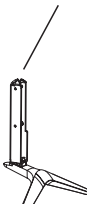
Make sure the following accessories are provided with the product.

Remote control unit	
	
Used with batteries inserted. Page 12	
“AA” size battery (x 2)	Operation manual
	
Page 17	
Stand unit	
<div style="display: flex; justify-content: space-between;"> <div style="width: 45%;"> <p>4T-C60AM1H</p> <div style="display: flex; justify-content: space-around;"> <div style="text-align: center;"> <p>“L”Stand unit</p>  </div> <div style="text-align: center;"> <p>“R”Stand unit</p>  </div> </div> <p style="text-align: center;">Stand unit</p> </div> <div style="width: 45%; text-align: center;">  <p>Screws (x4)</p> </div> </div>	
Stand unit	
<div style="display: flex; justify-content: space-between;"> <div style="width: 45%;"> <p>4T-C70AM1H</p> <div style="display: flex; justify-content: space-around;"> <div style="text-align: center;"> <p>“L”Stand unit</p>  </div> <div style="text-align: center;"> <p>“R”Stand unit</p>  </div> </div> <p style="text-align: center;">Stand unit</p> </div> <div style="width: 45%; text-align: center;">  <p>Screws (x4)</p> </div> </div>	

Preparation

Attaching the stand unit

- When you attach the stand unit, put the TV on a flat surface.
- Before attaching (or detaching) the stand unit, unplug the AC power cord from the AC power outlet.
- Before performing work, spread cushioning over the surface on which you will be laying the TV. This will prevent it from being damaged.

CAUTION

- Attach the stand unit in the correct direction.
- Be sure to follow the instructions. Incorrect installation of the stand unit may result in the TV falling over.

- 1** Place the TV on a flat surface with soft cushion on top of it. The left and right base components are respectively inserted into the grooves at the bottom of the TV set, please make sure the raised part of the base bracket is inserted into the TV set properly.

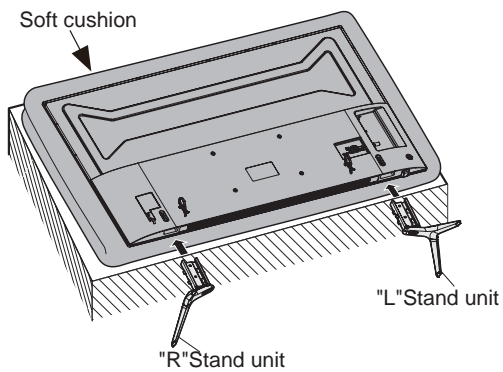

NOTE

- When installing the stand unit, you need to put your TV on a flat surface. Before that, put a soft cushion on the surface.
- To detach the stand unit, perform the steps in reverse order.
- The angle of the stand unit is not adjustable.
- A screwdriver is not supplied with this product.
- During installation, please be careful to avoid getting your hand trapped between the TV bottom and the floor.

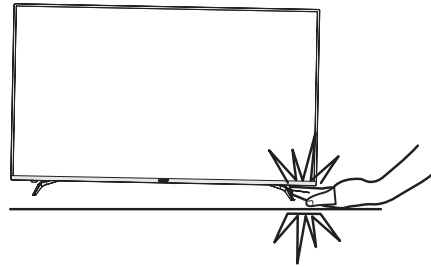

- 2** Insert 4 screws into 4 screw holes on the back of the TV set and tighten them.

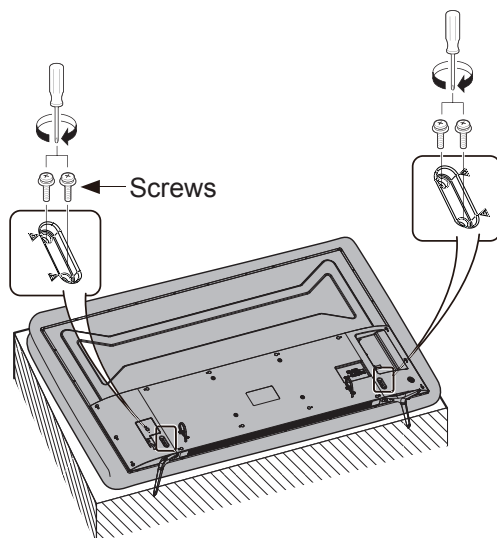

Preparation

How to make a simple platform (For 4T-C70AM1H only)

To make such a simple platform, you need to use the packing box and the three foam blocks inside it: TOP-L, TOP-C and TOP-R.

- 1 As shown in the following figure, remove the plastic lock at the bottom of packing box.

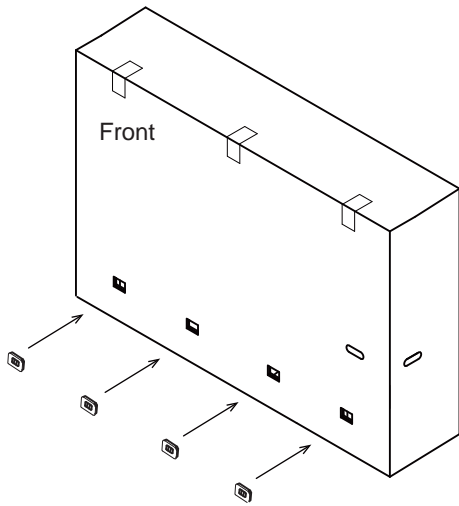

- 2 As shown in the following figure, remove the three foam blocks TOP-L, TOP-C and TOP-R on the top.

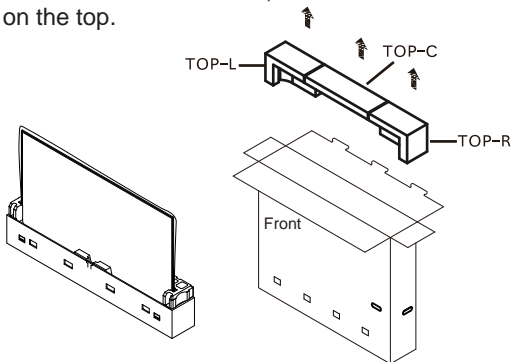

- 3
- 1 As shown in Figure A, place it face down.
 - 2 Insert the foam blocks TOP-L and TOP-R into the right side and left side of the packing box respectively (as shown in FigureB).
 - 3 Insert the foam block TOP-C into the packing box (as shown in FigureB). Now, a simple platform is ready.

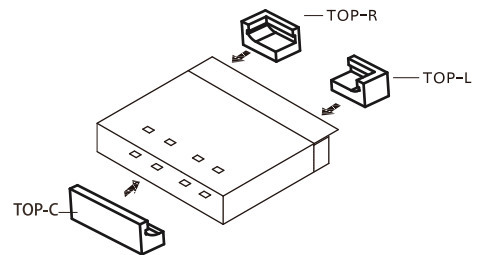

Figure A

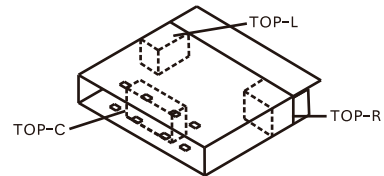

Figure B

NOTE

- Put the platform on the flat floor after you have made it.
- When installing the stand, you need to put the TV face down on the simple platform. Before that, put a shock pad on the platform to protect the screen.
- The simple platform is just for temporary use. Do not apply any load exceeding the weight of the LCD TV onto this platform.

Preparation

Handling and precautions with the wall-mounted TV

- You can mount the TV on the wall using the optional bracket.
- For details, refer to the instructions supplied with the optional bracket.

CAUTION

- **This TV should be mounted on a wall only with a wall mount bracket recommended by SHARP. The use of other wall mount brackets may result in an unstable installation and may cause serious injuries.**
- **Installing the TV requires special skills that should only be performed by qualified service personnel. Customers should not attempt to do the work themselves. SHARP bears no responsibility for improper mounting or mounting that results in accident or injury.**

Using a SHARP recommended bracket to mount the TV

- You can ask a qualified service professional about using a SHARP recommended bracket to mount the TV to the wall.
- Carefully read the instructions that come with the bracket before beginning work.

Part names

TV (Front)

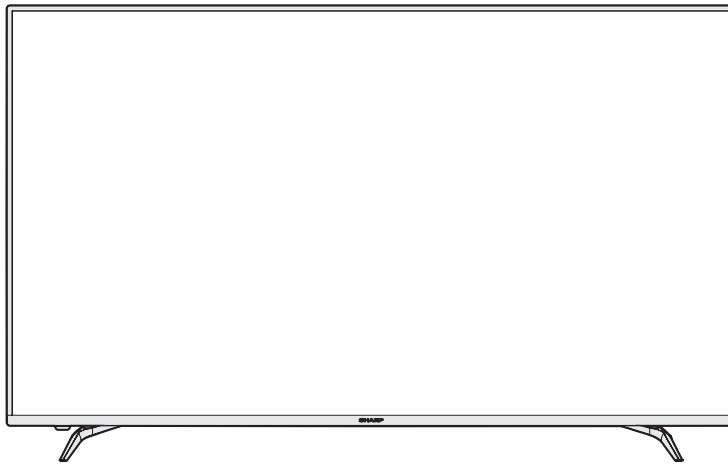

- The illustrations and on-screen displays in this operation manual are for explanation purposes and may vary slightly from the actual operations.
- The illustrations used throughout this operation manual are based on 4T-C60AM1H.

Preparation

TV (Rear)

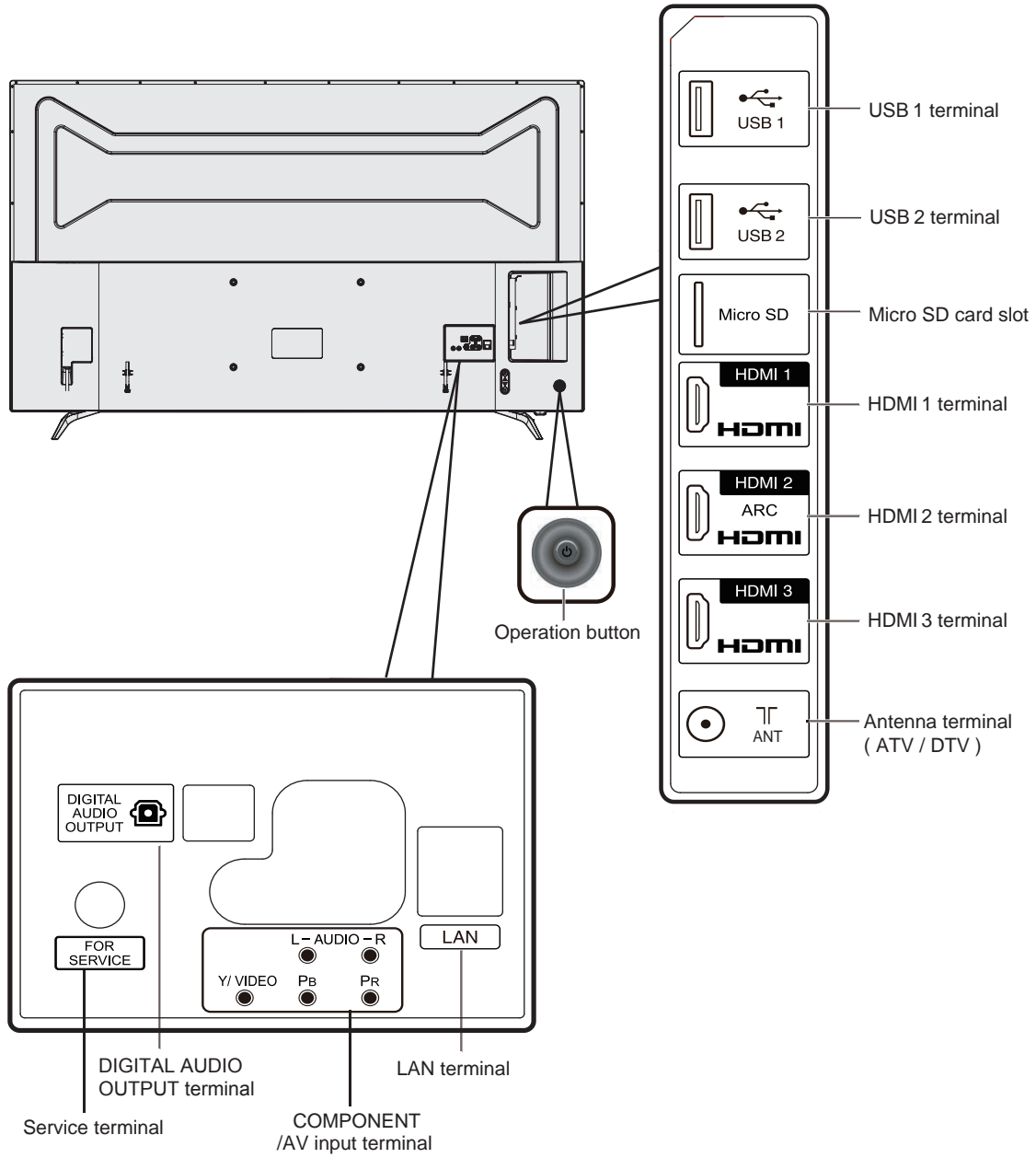

Preparation

Remote control unit

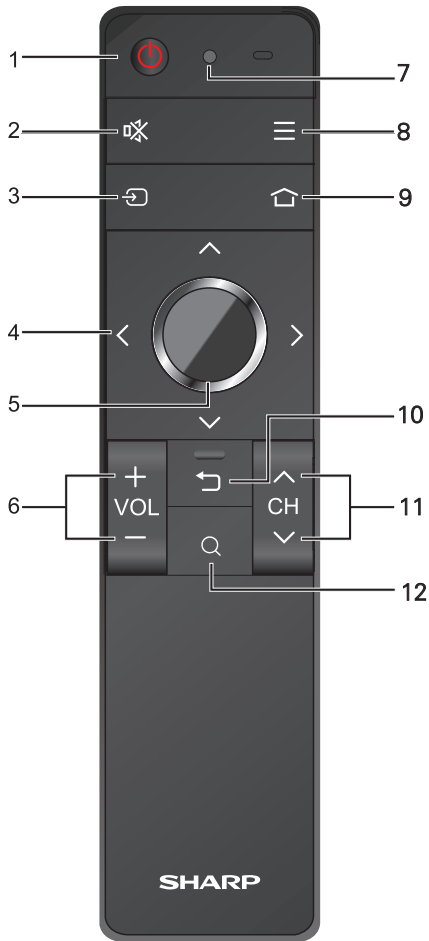

- 1 **⏻ (POWER (Standby/On))**
To switch the power on and off. (See page 18.)
- 2 **Mute**
Close the sound.
- 3 **Input source**
Select an input source.
- 4 **▲/▼/◀/▶ (Cursor)**
Select a desired item on the setting screen.
- 5 **OK**
Execute a command.
- 6 **VOL +/-**
Set the volume.
- 7 **Remote control indicator light.**
Indicates the working status of the remote control.
- 8 **≡ (MENU)**
Display the menu list.
- 9 **🏠 (HOME)**
Display the smart home.
- 10 **↩ (RETURN)**
Return to the previous menu screen.
- 11 **CH ▲/▼**
TV input mode: Select the channel up/down.
- 12 **Q (BROWSER)**
Start browser.
You may need to install browser app for the first time.

NOTE

- When the remote control is in sleep mode, please press any keys (except the power key) to wake up the remote control.

The indicator of the remote control

Indicator	Performance	Instructions state	Description
Blue	Rapid flash	Remind	Start the pairing.
	For 3 seconds	Remind	Pairing is OK.
Red	Slow flash for 3 seconds	Warning	Low battery, the remote control can still be used.
	Rapid flash for 3 seconds	Warning	Serious low-battery, the remote control cannot be used.
	For 3 seconds	Warning	Pairing timeout. Pairing is failed.
Blue, Red	Alternately flash	Remind	Remove current pairing, the new remote control can pair to the TV at this time.

Preparation

The operation button

You can also setup the TV through the operation button at the TV back. (The position of the operation button, please see page 11)



Action	Description
Short press	Turn on the TV.
Left/Right	Set the volume reduction/add.
Up/Down	Set the channel up/down.
Long press	Display the menu (Pairing ,Power off) when the TV is switched on.

Remote control pairing

The remote control unit has been pre-paired with the TV set in factory so you can use the remote control unit directly. If the remote control fails to operate or a new remote control unit is used, please follow the following steps to pair the remote control unit and the TV.

- 1 Press the "⏻" button on the TV for a few seconds, "Pairing" and "Power off" menu will be displayed.
- 2 Use the operation button on the TV to choose "Pairing" and then press the TV operation button.
- 3 Point the remote control unit towards the bottom left corner of TV (within 20cm), press "OK" and "⏻" at the same time until red and blue lights stop flashing alternately.
- 4 Press "OK" on the remote control unit to complete the Bluetooth pairing.

NOTE

- If the TV does not display the remote control pairing information, the "Pairing" Interface will be displayed automatically. Press **OK** & **⏻** (POWER) on the remote control unit at the same time, the red and blue lights flash alternately. Once the flashing stop, press **OK** to complete the Bluetooth pairing.
- If pairing is not succeed, please try again or contact the customer service center.

Preparation

Before turning on the power

Notes on installing the TV

- Avoid direct sunlight and place the TV in a well-ventilated location.
- Place the TV in a level location.
- Do not turn on the power of the TV before connecting the AC cord.
- If there are any protective plastic sheets on the TV cabinet, please take them off before connecting.

1 Connecting the antenna cable

To enjoy a clearer picture, use an outdoor antenna. The following is a brief explanation of the types of connections that are used for coaxial cable.

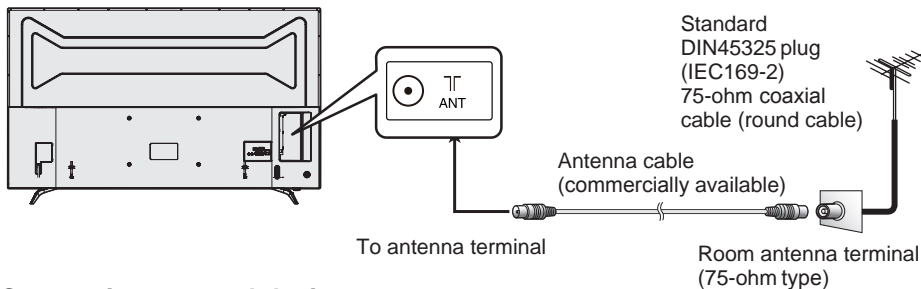

2 Connecting external devices

See page 15 and 16 for connecting external equipment, such as a VCR and DVD player.

3 Plug the AC cord into the AC outlet.

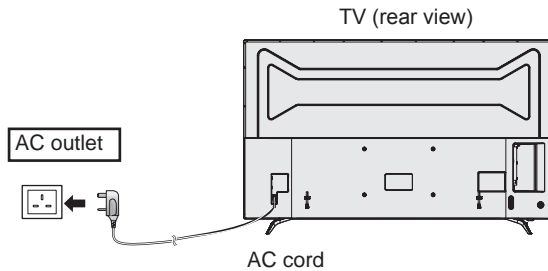

- Place the TV close to the AC outlet, and keep the power plug within reach.
- Disconnect the AC cord from the AC outlet if the TV will not be used for a long period of time.

4 Bundling the cables

As the picture illustrated, insert the cable clip into the hole on the TV, and put the cable into the cable clip for banding.

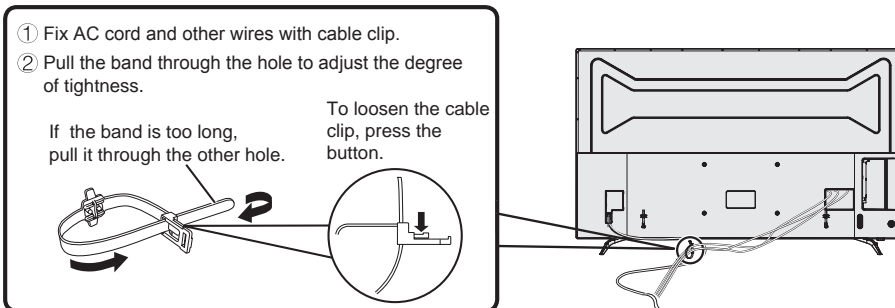

CAUTION

- To prevent risk of electric shock, do not touch un-insulated parts of any cables with the AC cord connected.

Preparation

Connecting external devices

You can connect many types of external equipment to your TV, like a VCR, Digital TV Set Top Box (STB), game console, camcorder, DVD player and PC. To view external source images, select the input source of remote control or the TV icon on the smart home and then press **OK**.

CAUTION

- To protect all equipment, always turn off the TV before connecting to a VCR, game console, camcorder, DVD player, Digital TV Set Top Box (STB), PC or other external equipment.
- Refer to the relevant operation manual (Digital TV Set Top Box (STB), VCR, DVD player, etc.) carefully before making connections.

When using HDMI cable (commercially available)

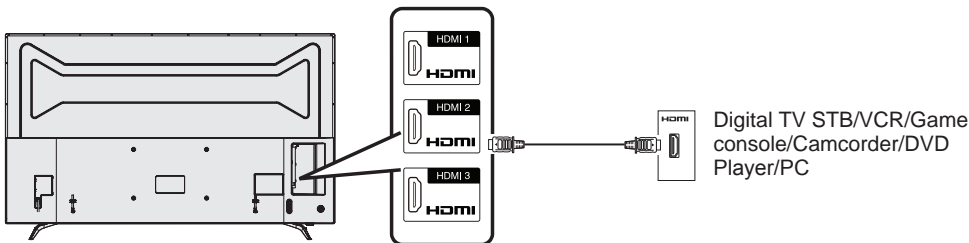

NOTE

- When using a TV set-top box to watch TV programs, use the set-top box remote control to switch channels.

When using component cable* (commercially available)

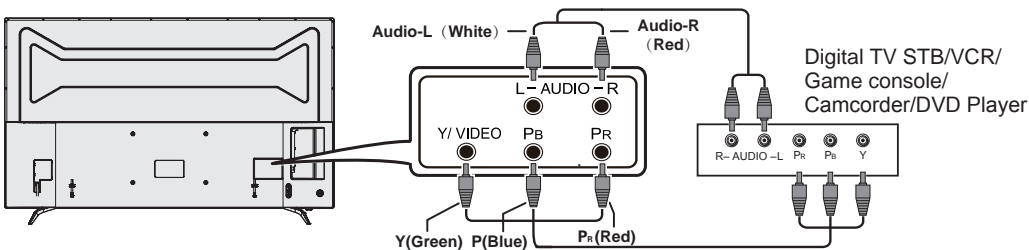

- * The component and AV input share the same terminal.

NOTE

- Insert the terminals by colour.

When using AV cable* (commercially available)

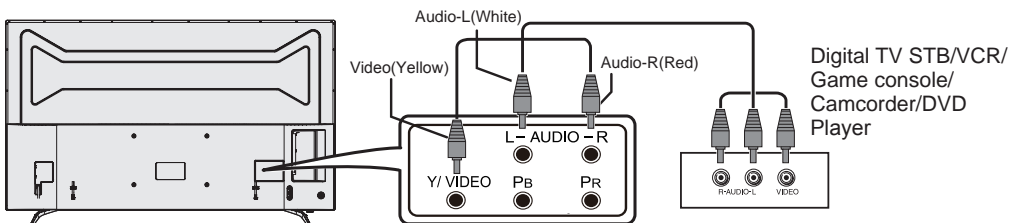

- * The component and AV input share the same terminal.

NOTE

- Insert the terminals by colour.

Preparation

Using digital audio output

It is possible to output audio through the DIGITAL AUDIO OUTPUT terminal. PCM or RAW (Dolby Digital or DTS audio) outputs from the terminal.

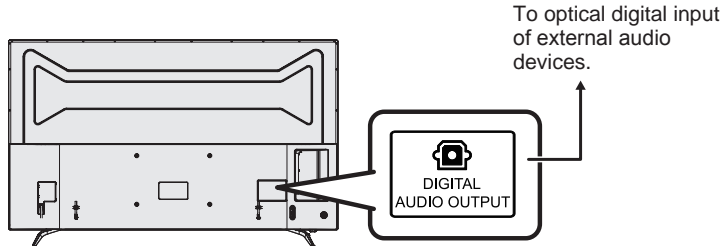

NOTE

- The DIGITAL AUDIO OUTPUT terminal usually outputs the same audio from the speakers. (The audio of the content you are viewing is output from the terminal.)
- The DIGITAL AUDIO OUTPUT terminal does not output some signals, depending on devices and software.
- When DIGITAL AUDIO OUTPUT is used, the speakers sound will be muted.

Inserting a Micro SD memory card (commercially available)

It provides access to Apps ,video,music,and other files in Micro SD memory cards. Insert a Micro SD memory card that stores your files into the Micro SD slot. Refer to the method of playing files stored in the USB device specified on page 27 for details.

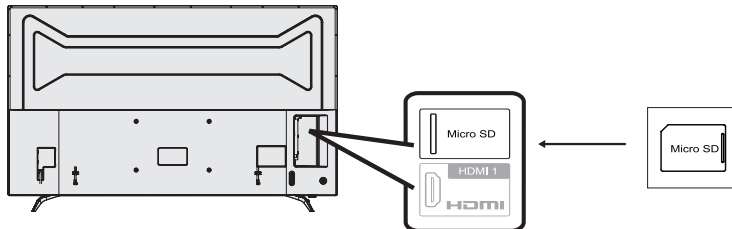

NOTE

- Insert the memory card into the slot in the direction shown in the figure.
- The SD slot supports Micro SD type memory cards. However some memory cards may not be supported.
- This product supports memory cards with a maximum storage of 32 GB. We recommend that you use a memory card with at least a speed of Class 4 for a higher read-write speed, thus guaranteeing the system performance.
- Unplug the memory card after you have safely unloaded it or the TV has been turned off.
- Do not unplug the memory card while data is being transferred. Otherwise the TV may malfunction.
- Regularly back up data in the memory card to prevent data corruption or operating errors of the TV. (SHARP shall not bear any responsibility for data corruption or destruction.)

Connecting a USB memory device

See page 27.

Connecting to the Network

See page 24 to 25.

Preparation

Inserting the batteries

Before using the TV for the first time, insert two “AA” size batteries (supplied). When the batteries become depleted and the remote control fails to operate, replace the batteries with new “AA” size batteries.

1 Open the battery cover.

Figure 1: Hold the front part of the remote control with one hand, pull the handle rope with another hand.

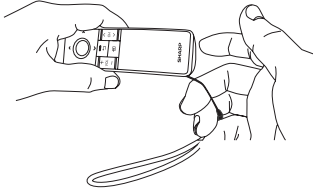

Figure 2: Place your thumb in the groove at the bottom.

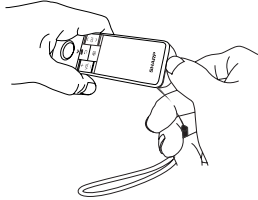
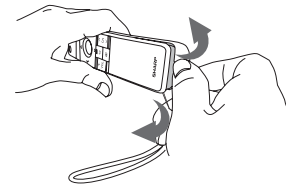
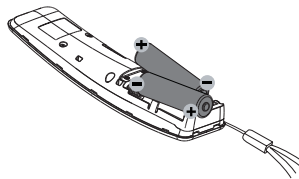

Figure 3: Pull the handle rope with your middle and index fingers and use your thumb to open the battery cover.



2 Insert the two supplied “AA” size batteries.

Place batteries with their terminals corresponding to the (+) and (-) indications in the battery compartment.



3 Close the battery cover.

Close the battery cover from top to bottom.

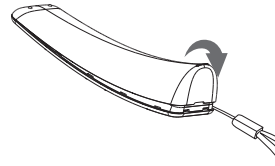

CAUTION

Improper use of batteries can result in chemical leakage or explosion. Be sure to follow the instructions below.

- Do not mix batteries of different types. Different types of batteries have different characteristics.
- Do not mix old and new batteries. Mixing old and new batteries can shorten the life of new batteries or cause chemical leakage in old batteries.
- Remove batteries as soon as they have worn out. Chemicals that leak from batteries can cause a rash. If you find any chemical leakage, wipe thoroughly with a cloth.
- The batteries supplied with this product may have a shorter life expectancy due to storage conditions.
- If you will not be using the remote control unit for an extended period of time, remove the batteries from it.
- Batteries shall not be exposed to excessive heat such as sunshine, fire or the like.

Cautions regarding the remote control unit

- Do not subject the remote control unit to shock. In addition, do not soak the remote control unit with liquids or place it in an area with high humidity.
- Do not install or place the remote control unit under direct sunlight. The heat may cause deformation of the unit.

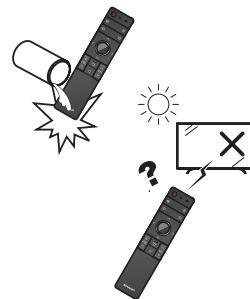

Preparation

Turning the TV on/off

Running the TV for the first time

After inserting the AC cord, the TV is in standby. Press **⏻ (POWER)** on the remote control or on the TV:

- TV is switched on.
- You can switch the TV to standby by pressing **⏻ (POWER)** on the remote control .

Turning off the TV

If the TV is switched on, press **⏻ (POWER)** on the remote control :

- TV is switched into standby and the image disappeared.
- Press **⏻ (POWER)** on the remote control to turn on the TV.
- If you want to turn off the TV from standby, please pull out the AC cord.

NOTE

- If you are not going to use this TV for a long period of time, be sure to remove the AC cord from the AC outlet.
- A small amount of electric power is still consumed even the TV is in standby mode.
- If the TV loses power in special circumstances (such as power outage or grid fluctuations, etc.), it may not work well when it is switched on again. Please try to power off the TV (by the **⏻ (POWER)** on the remote control) or unplug and replug the AC cord to restart the TV.
- It is a normal phenomenon when the TV temperature rises in the process of watching TV.
- Please do not cut off the power casually in the process of switching on or switching off the TV, running APPS or updating, otherwise TV system could not work correctly. Please turn off the TV after closing all APPS.

User Guide

When the TV powers on for the first time after purchase, the setting wizard appears. Follow the menus and make the necessary settings one after another.

Confirm the following before turning on the power

- Is the antenna cable connected?
- Is the AC cord plugged in?

Press **⏻ (POWER)** on the TV.

- It displays the boot screen , and then “Language Setting” appears.
- It may cost a little time when TV is switched on for the first time. Please wait patiently.



Language Setting

You can select the Language Setting among the “繁體中文”，“简体中文” or “EN” .

Please Select The Environment

Please select “Home” when you watch TV at home.

- “Home”: “STANDARD” will be the default value for the “picture mode” setting.
- “Store”: “Store” is only for retail store displays. “Bright” will be the default value for the “picture mode” setting.

Network Setting

You can select “Ethernet” or “Wi-Fi” to connect the network.

Please see page 24 to 25.

Watching TV

When the initial setup has completed, you can enter to smart home.

Press the ▲/▼/◀/▶ to the TV ,and press **OK** , then press ◀/▶ to move to ATV, DTV,or the input sources, and then press **OK** to play the program in full-screen.

NOTE

- Auto search will carry out when switching to ATV or DTV at the first time.

MENU

Numeric keypad

Press ▲/▼/◀/▶/OK to input the number , it will swith to the selected channel.

Video

Set the video as you desired.

Picture mode

You can select "Standard", "Movie", "Game", "Comfort", "Sports", "Vivid", "Bright", "Custom", "Dolby Vision Bright", "Dolby Vision Dark", "Dolby Vision Dynamic".

Contrast/Brightness/Tint/Sharpness/Colour/Backlight

You can adjust the picture to your preference.

Selected item	◀ button	▶ button
Contrast	For less contrast	For more contrast
Brightness	For less brightness	For more brightness
Tint	Skin tones become reddish	Skin tones become greenish
Sharpness	For less sharpness	For more sharpness
Colour	For less colour intensity	For more colour intensity
Backlight	The screen dims	The screen brightens

NOTE

When "Bright" is selected for picture mode, "contrast", "Brightness", "Tint", "Sharpness", "Colour" and "Backlight" cannot be adjusted.

Audio only

Press ◀/▶ to select **OK** or Cancel. Select **OK** and screen will be turned off. Select Cancel and screen will keep turning on.

Wide mode

You can select different picture size that account for the kind of each picutre.

Selected item	Description
Normal	For 4:3 standard pictures. A side bar appears on each side.
Zoom 14:9	For 14:9 letterbox pictures. A thin side bar appears on each side, and you may also see bars on the top and bottom with some programmes.
Panorama	In this mode the picture is progressively stretched toward each side of the screen.
Full	For 16:9 squeeze pictures.
Cinema 16:9	For 16:9 letterbox pictures. Bars may appear on the top and bottom with some programmes.

Selected item	Description
Cinema 14:9	For 14:9 letterbox pictures. Bars may appear on the top and bottom with some programmes.
Dot by Dot	Display an image with the same number of pixels on the screen (only when receiving 2160p signal).
Underscan	Display with an underscan image only when receiving a 720p / 1080i / 1080p signal. Display with the High-Definition image adjusted optimally. Noise may appear on the edge of the screen with some programmes.

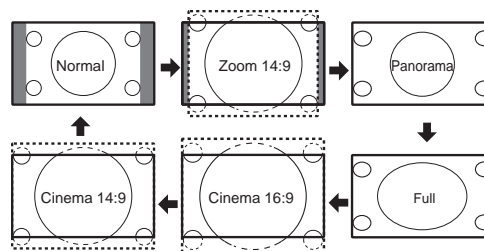

NOTE

- Some picture sizes may not be displayable depending on the input signal.
- "Zoom 14:9" and "Cinema 14:9" are only available for the DTV or ATV mode.

Advanced

Gamma setting

You can adjust mid-level brightness.

Colour temp. (Colour temperature)

Adjusts the colour temperature to give the best white image.

You can select "Low", "Mid-low", "Middle", "Mid-high", or "High".

DNR

Reduce noise on screen and produces a clearer video. You can select "Auto", "Off", "Low", or "High".

Active contrast

Automatically adjust the contrast of an image according to the scene.

You can select from "On", or "Off".

Fine Motion

Using the fine motion function can view the high speed motion image more clearly.

You can select "Off", "Standard", or "Advanced".

NOTE

- Only applicable for 24/30Hz input signal.

Intelligent variable contrast

The function divides the backlight into different segments according to picture brightness. It constantly analyzes and adjusts the brightness of the input signal to optimize the picture brightness which brings brilliant and colourful image. You can select "Off", "Low", "Middle", "M-high" or "High".

HDR gamma setting

You can adjust HDR input pictures.

Watching TV

Reset

Reset all picture adjustment items to the factory preset.

Audio

Audio mode

This function enables you to select appropriate setting for audio and video to account for the system environment.

You can select from "Standard", "Movie", "News", "Music", "Custom".

Auto volume

Different sound sources sometimes do not have the same volume level, such as a programme and its commercial breaks. The automatic volume control (Auto volume) reduces this problem by equalizing levels.

Bass/Treble/Balance

You can adjust the audio of the selected Audio mode.

Selected item	◀ button	▶ button
Bass	For weaker bass	For stronger bass
Treble	For weaker treble	For stronger treble
Balance	Decrease audio from the right speaker	Decrease audio from the left speaker

Surround sound

The surround sound function produces a surround effect from the speakers.

NOTE

- When "Music" is selected for Audio mode, "Auto Volume", "Bass", "Treble", "Balance" and "Surround sound" cannot be adjusted.

Digital audio output

This function allows you to select your favourite audio output system.

Item	Description
OFF	Take digital audio output off.
SPDIF-PCM	PCM format output through SPDIF fibre-optical.
SPDIF-RAW	Raw data format output through SPDIF fibre-optical.
ARC-PCM	PCM format output through HDMI ARC.
ARC-RAW	Raw data format output through HDMI ARC.

NOTE

- Analog channel audio and video input audio are output in PCM mode even when "RAW" is selected.
- PCM digital input signals are output in PCM mode even when "RAW" is selected.
- When digital audio output is used, speakers sound will be muted.

MPX

You can switch between multiple audio modes when watching a multiple audio or stereo broadcast programme.

In the NICAM TV broadcasts

Signal	Mode switch
When receiving a stereo signal	NICAM STEREO, NICAM MONO
When receiving a bilingual signal	NICAM DUAL I , NICAM DUAL II , NICAM DUAL I + II , NICAM MONO.
When receiving a monaural signal	NICAM MONO, MONO

In the TV mode of A2 TV broadcasts

Signal	Mode switch
When receiving a stereo signal	STEREO, MONO
When receiving a bilingual signal	CH A, CH B, CH AB
When receiving a monaural signal	MONO

- Press **≡ (MENU)** to display the menu screen in full-screen TV programs. Press **▲/▼** to select the "Audio", and then press **OK**.
- Press **▲/▼** to select "MPX" and then press **OK**.
- Press **◀/▶**, press **OK** to select the desired audio .

NOTE

- Select the audio mode for ATV only.

Reset

Reset all audio adjustment items to the factory preset values.

Channel setting

Program list

Display the channel list.

- Press **≡ (MENU)** to display the menu screen in full-screen TV programs. Press **▲/▼** to select the channel setting, and then press **OK**.
- Press **▲/▼** to select "Program list", and then press **OK**.

Label

You can change individual channel names.

- Press **≡ (MENU)** to display the menu screen in full-screen TV programs. Press **▲/▼** to select the channel setting, and then press **OK**.
- Press **▲/▼** to select "Label", and press **OK**.
- Press **▲/▼/◀/▶** to select TV channel, and then press **OK**.

Watching TV

- Press **▲/▼/◀/▶/OK** to select a character, and then press **↵ (RETURN)** to save and exit.

NOTE

- Maximum 6 alphanumeric characters can be input.
- Labeling is only available for the ATV mode.

Sort

Channel positions can be sorted freely.

- Press **≡ (MENU)** to display the menu screen. Press **▲/▼** to select "Sort", and press **OK**. Press **▲/▼/◀/▶** to select desired TV program, and then press **OK**.
- Press **▲/▼/◀/▶** to move it to the desired position, and then press **OK**.

- Repeat the above operation until the completion of all of the channel.

Skip

Channels which have been set to "Skip" are passed over, even if using **CH ▲/▼** to select them.

- Press **≡ (MENU)** to display the menu screen. Press **▲/▼** to select "Skip", and press **OK**.
- Press **▲/▼/◀/▶** to select the channel, and then press **OK** to skip.
- You can select "Skip" and press **OK** again to cancel the skip.

Delete

Channels can be erased individually.

- Press **≡ (MENU)** to display the menu screen.
- Press **▲/▼** to select "Delete", and then press **OK**.
- Press **▲/▼/◀/▶** and then press **OK**. select **OK** to erase the selected channel.

Info

Display the information of the programs, only for DTV.

- Press **≡ (MENU)** to display the menu screen in full-screen TV programs.
- Press **▲/▼** to select channel setting, and then press **OK**. Press **▲/▼** to select "Info" and then press **OK**.

EPG

The EPG (Electronic Programme Guide) is broadcasted together with DTV. The TV screen shows the EPG when you select it, provided that the TV is receiving the digital broadcasting signal. The EPG enables you to check the schedule of DTV and view detailed information.

- Press **≡ (MENU)** to display the menu screen in full-screen TV programs.

- Press **▲/▼** to select channel setting, and then press **OK**. Press **▲/▼** to select "EPG" and then press **OK** to display programme information.

NOTE

- The time displayed on the EPG is information sent by the TV station.

Signal strength

The states of Signal strength indicate when to check the appropriate alignment of the antenna.

Auto search

You can run auto installation again, even after setting up the preset channels.

Manual search

In DTV menu, you can add new services within a specified frequency band.

In ATV menu, you can set the channel manually. Referring the following table.

Item	Description
Current CH	The current channel number you want to edit.
Color system	Select the optimum colour system to receive. (PAL, SECAM, NTSC)
Sound system	Select the optimum sound system (Broadcasting system) to receive. (BG, DK, I, M)
Search	Start searching from current channel. You can search the next channel by pressing ◀/▶ to adjust the frequency.
Fine-Tune	Tune the frequency of the stored channel to your desired position.

Audio Language

Setup preferred audio language for DTV only.

- Press **≡ (MENU)** to display the menu screen in full-screen TV programs.
- Press **▲/▼** to select "Audio Language" and then press **OK**.
- Press **◀/▶** to select the desired audio language, and then press **OK**.

Subtitle Language

Setup preferred subtitle language if the subtitle languages are available.

- Press **≡ (MENU)** to display the menu screen in full-screen TV programs.
- Press **▲/▼** to select "Subtitle Language" and then press **OK**.
- Press **◀/▶** to select the desired subtitle language, and then press **OK**.

Watching TV

PinP

- 1 Press **≡ (MENU)** to display the menu screen in full-screen TV programs.
- 2 Press **▲/▼** to select "PinP" and then press **OK**.
- 3 If you want to return full screen, long press **⏠** in the TV remote, and then press **OK**.

HDMI Menu

HDMI setting

■ HDMI select

Select from "Standard", "Enhance".

■ PC Mode

Select from "On" or "Off".

■ HDMI CEC

Select from "On" or "Off".

If you select "On", HDMI Connected devices will keep co-movement with TV.

TV setup

According to your needs to set the options table.

General

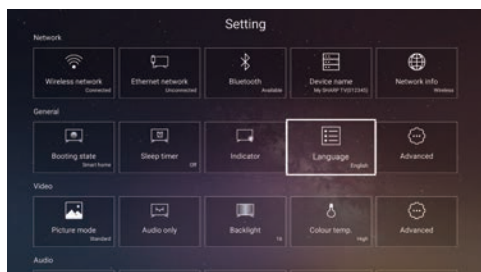

Booting state

You can set booting state between "TV" and "Smart home".

NOTE

- "TV": When turn on the TV, it displays TV mode.
- "Smart home": When turn on the TV, it displays the smart home.

Sleep timer

Auto power-off at a designated time.

You can choose from "Off", "30min.", "60min.", "90min.", "120min.", "150min." or "Custom".

NOTE

- When the time has been set, countdown automatically starts.

- Five minutes before the preset of time expires, the remaining time displays each minute.

Standby indicator

You can set indicator for TV standby. Select from "On" or "Off".

Language

You can select a language from the menu.

Select from among 3 languages: "English", "繁體中文" or "简体中文".

Advanced

■ Default input method

For setting input method.

NOTE

- The initial installation of the TV is "IQI-International".
- If you use any other input method, SHARP cannot guarantee its compatibility with television system.

■ Super quick

Select from "Off", "Super quick".

■ No signal power off

You can set the TV to automatically power off in about 15 minutes after the TV goes into a state of receiving no programme signals.

Five minutes before the power shuts down, the remaining time displays every minute.

■ Keypad sound

Select from "On" or "Off".

■ PinP size

Select from "Big", "Middle" or "Small".

■ Digital audio language

Set up to preferred multi audio languages to display if the audio languages are available.

NOTE

- This function depends on audio language information from broadcasters.
- If audio for the selected language is not included in a received broadcast, audio will not be output for that language.

■ Subtitle

Setup preferred subtitle language if the subtitle languages are available.

NOTE

- If subtitles for the selected language are not included in a received broadcast, subtitles will not be shown for that language.

Network

Please see pages 24 to 25.

Watching TV

Apps

Please see pages 26.

System

You can view and set the info about the system.

System info

From here, you can view the Hardware Info and Software Info.

Legal info

From here, you can view the open source licenses.

Local update

This function allows you to transform to the latest software via a USB device.

NOTE

- If the software is not compatible with the system, an error message appears on the screen. Please enter TVsetup→ System→ local update to operate.
- When an error message displays, check to see if
 - The USB device is inserted firmly.
 - The USB memory has two or more software files.
 - No software for updating the system exists in the USB memory.
 - The software file is broken.
 - The software file is not compatible with your TV's software.
- Please do not turn off TV or execute other operations during version up.

System recovery

If complex adjustments are made and the settings cannot be restored to normal, you can reset the settings to the factory preset values.

Network function

Connecting to the Network

To enjoy internet services, you need to connect the TV to a router with a high speed connection to the internet.

NOTE

- If you do not have a broadband internet connection, consult the store where you purchased your TV or ask your internet service provider or telephone company.
- A stable connection speed is required to play back streaming content, otherwise you may not be able to watch normally.

Wired installation

Switch on the router (commercially available). Refer to the router's operation manual for switching on. Connect the LAN terminal on the TV to the router (commercially available) with a LAN cable (commercially available).

Wired connection overview

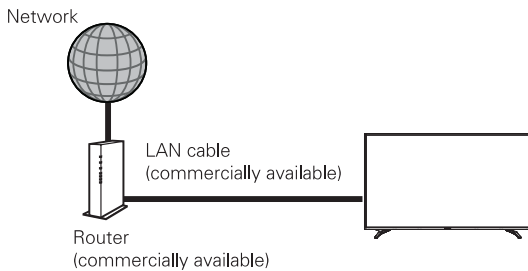

How to connect

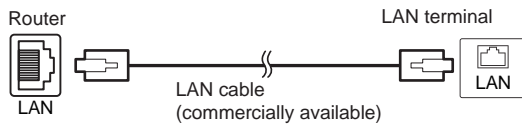

Wireless installation

Switch on the router (commercially available). Refer to the router's operation manual for switching on.

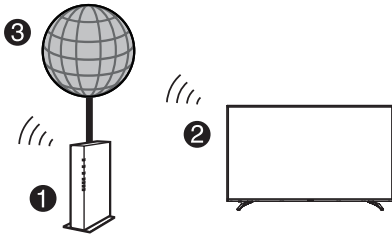





- 1 Wireless LAN router/access point
- 2 TV
- 3 Network

NOTE

- This TV has received the following certifications.
 - Wi-Fi CERTIFIED™ (certifications program from the Wi-Fi Alliance®)
- A wireless LAN connection and performance cannot be guaranteed for all residential environments. In the following cases, the wireless LAN signal may be poor or drop, or the connection speed may become slower.
 - When used in buildings made with concrete, reinforced steel, or metal.
 - When placed near objects that obstruct the signal.
 - When used with other wireless devices that emit the same frequency.
 - When used in the vicinity of microwave ovens and other devices that emit a magnetic field, electrostatic charge, or electromagnetic interference.
- Make sure the firewalls in your network allows access to the TV wireless connection.
- Operations cannot be guaranteed when used with access points that do not have Wi-Fi® certification.
- A wireless LAN access point is required to connect the TV to the Internet using a wireless LAN. See the operation manual of your access point for setup.
- A stable connection speed is required to play back streaming content. Use a wired connection if the wireless LAN speed is unstable.
- As there are lots of formats in the internet, some formats may not be supported by this TV unit.
- Before transferring to a third-party or disposal, be sure to initialise the wireless LAN settings.

Network function

Network setting

Press  (Home) to display the smart home. Press /// to select "TV setup", and then press **OK**. It to display setting screen.

Wireless network connection

You can select "Wi-Fi" to connect the network.

When adjust "Wi-Fi" to "On", it displays the nearby wireless network.

If the current network connection security is not open, you should enter the password from software keyboard by pressing **OK** on the remote control.

■ Add network

You can add unbroadcast wireless network manually. Enter the information about the unbroadcast wireless network, and then select "Connect". Now the TV is connected to the unbroadcasted wireless network.

Ethernet network connection

You can select "Ethernet" to connect the network.

■ Manual connecting

You can setup IP address, Subnet mask, Gateway, First DNS and Second DNS following the on-screen instructions.

■ DHCP

System will attempt to obtain IP address and other information automatically.

Bluetooth®

Select the "Bluetooth" and then press **OK**, the TV is scanning Bluetooth devices.

If you want to connect to the Bluetooth device, please refer to the screen reminder.

NOTE

- The Bluetooth device may not operate properly depending on the device being used.

Device name

Set the name for this TV.

You can choose from "My SHARP TV(012345)", "Bedroom", "Second bedroom", "Living room", "Study", "Office", "Custom".

Network info

Check the information for Internet connection.

Smart function

You can download and install amounts of Apps from the third-party of the smart TV.
Press **HOME** to display the smart home.

Smart home

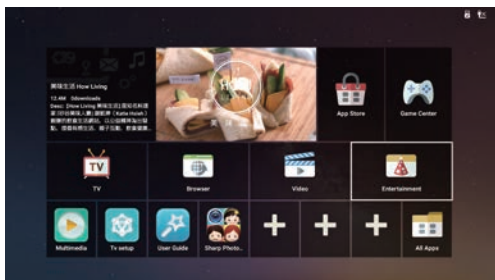

Select an input source (ATV,DTV, HDMI1, HDMI2, HDMI 3, AV, COMPONENT) and then press **OK** on the remote control.

In APP screen, you can experience the supplied applications provided with the TV, also you can download more apps from the app store.

Installing Apps

From "App Store", select the App you desired, and install it according to prompt in the screen.

Apps

Storage

From here, you can view the free space and the total storage space of TV.

Install

From here, you can setup whether applications are allowed to install from unknown sources.

Apps

Check the information of the installed apps and set for each of them.

You could manage all Apps that have been downloaded into TV.

■ Downloaded apps

Check the downloaded apps.

■ System apps

Check the system apps.

Format Micro SD card

To format Micro SD card .

NOTE

- If you format Micro SD card, the content stored in the Micro SD card will be deleted completely and the content is unrecoverable. Please operate it carefully.

Safely Remove Micro SD card

Remove Micro SD card after you have safely unloaded it.

NOTE

- Do not unplug the memory card while data is being transferred. Otherwise the TV may malfunction.
- Unplug the memory card after you have safely unloaded it or the TV has been turned off.
- Please regularly back up data in the memory card to prevent data corruption or operating errors of the TV. (SHARP shall not bear any responsibility for data corruption or destruction.)

Browser

In smart home screen, select "Browser" and press **OK**, or press **Q(BROWSER)** on the remote control to start browsing internet.

Other useful features

You can connect a USB memory device or a USB hard disk drive (HDD) to the TV to enjoy viewing pictures, listening to the audio, and watching videos.

NOTE

- Depending on the USB memory device, the TV may not be able to recognise the data.
- It may take time to read the data if the USB memory device contains many files or folders.
- External subtitles for some video files may not be supported.

Connecting a USB memory device

Insert the USB memory device with recorded pictures audio or videos into the USB 1 or USB 2 terminal on the TV.

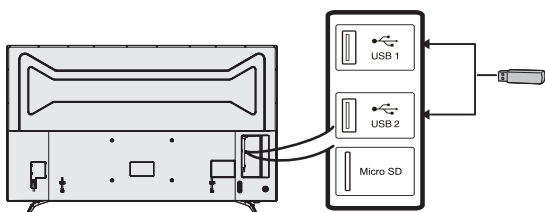

- The USB1 and USB2 terminals cannot be connected with USB hard disk drives at the same time.
- When connecting a USB hard disk drive, be sure to use a hard disk drive with an AC adapter.
- Do not remove the memory device from the TV while transferring files.
- Do not insert and remove a USB memory device / USB hard disk drive to and from the TV repeatedly.
- When using a card reader, be sure to insert Memory card first before using the card reader.
- The TV may not be able to recognise the card reader.
- Please follow the rules below when the TV is displaying the file of the USB device:
 - Please do not turn off the TV directly.
 - Please do not disconnect the USB device directly.
 - Please be sure to exit from USB interface before removing the USB device, otherwise you may lose the data, damage the device or TV system may not work properly.
- If the TV connects with USB-HUB, the TV may not be able to recognise all USB memory devices.

CAUTION

- Do not use the USB extension cable, otherwise it may cause the TV does not work properly.
- Please insert the USB device after the TV is powered on properly.



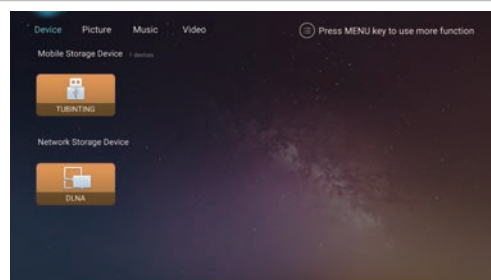

















Playing back files on a USB memory device



- 1 Press **HOME** to display the smart home. Select "Multimedia" and then press **OK**.
- 2 Press **▲/▼/◀/▶** to select the device or disk drive you want.
- 3 Press **▲/▼/◀/▶** to select the desired folder, and then press **OK**.
 - Press **RETURN** on the remote control, you can exit to the upper folder.
- 4 Press **MENU** to display the USB media operation menu when you view a photo or a video. Press **▲/▼** to select the relevant functions, and then press **OK**.
To know the buttons for USB media operation in detail, please see page 28.

Other useful features

Buttons for USB media operation

Button/menu	Description	Video mode	Music mode	Picture mode
	Play/Pause.	✓	✓	-
	Repeat all songs.	-	✓	-
	Play in order.	-	✓	-
	Play in random order.	-	✓	-
	Play this song only once.	-	✓	-
	Repeat current song .	-	✓	-
	Playlist Select a file from the playlist to start playback.	✓	✓	-
 Scale	Press CH \wedge / \vee to switch photo size. Press \blacktriangle / \blacktriangledown / \blacktriangleleft / \blacktriangleright to move.	-	-	✓
 Rotate	Rotate the picture Press \blacktriangleleft or \blacktriangle to rotate the image 90 degree anticlockwise, and press \blacktriangleright or \blacktriangledown to rotate the image 90 degree clockwise. Press \blackleftarrow to exit this mode.	-	-	✓
 Sliding	Set the Time Interval and Animation of the slide.	-	-	✓
 Subtitle setting	Set Subtitle on-off, Subtitle switching, and Subtitle advanced.	✓	-	-
 Audio setting	Select audio track.	✓	-	-
 Play setting	Set Single Cycle and Breakpoint play .	✓	-	-
 Jump time	Set the starting playback time.	✓	-	-
	Press OK to the previous file.	✓	✓	-
	Press OK to the next file.	✓	✓	-
	Press \blacktriangleright to fast forward.	✓	-	-
	Press \blacktriangleleft to reverse.	✓	-	-
\blacktriangleleft	Go to the previous file.	-	-	✓
\blacktriangleright	Go to the next file.	-	-	✓
	Set Quit Time .	-	✓	-
	Press \blacktriangle / \blacktriangledown to select "PinP" and then press OK .	✓	-	-
	Press \blacktriangleleft / \blacktriangleright to select OK or Cancel. Select OK and screen will be turned off. Select Cancel and screen will keep turning on.	-	✓	-

Other useful features

List of file formats compatible with USB mode

Supported video format

File extension	Decoder
.3gp	H.263 H.264 HP@Up to Level 4.1 H.264(AVC) BP@L4.0 H.264(AVC) MP@L4.0
.avi	H.264 MP@L 4.0 H.264 HP LV 5.1 H.264 HP@Up to Level 4.1 H.264 (AVC) MP@L 4.1 MPEG2 MP@HL
.flv	H.264 BP LV 4.0 H.264 HP@Up to Level 4.1 H.264(AVC) MP@L4.1
.m2ts	MPEG2 MP@HL H.265(HEVC) MP / Main 10 Profile @ Up to Level 5.1
.mkv	H.264 HP@Up to Level 4.1 H.264 (AVC) MP@L 4.1 H.265(HEVC) MP / Main 10 Profile @ Up to Level 5.1
.mov/m4v	H.264 HP@Up to Level 5.1 M-JPEG
.mp4	H.264 HP@Up to Level 5.1 H.264(AVC) BP@L4.0 H.264(AVC) MP@L4.0 MPEG4 SP, MPEG4 ASP@Level 5 MPEG4 SP@HL 3.0 & MPEG4 ASP@HL 4.0 H.265(HEVC) MP / Main 10 Profile @ Up to Level 5.1
.mpg/vob/mpeg	MPEG1 MP@HL MPEG2 MP@HL
.rmvb	Real Video 9
.trp/tp	MPEG2 MP@HL
.ts	H.264 BP@Up to Level 4.0 H.264 HP@Up to Level 5.1 H.264(AVC) BP@L3.1 H.264(AVC) MP@L4.1 MPEG2 MP@HL H.265(HEVC) Main / Main-10 Profile @ Up to Level 5.1
.webm	VP8

Supported picture format

File extension	Picture decoder
JPEG	progressive 4000*4000 baseline 8000*8000
PNG	4096*5760
GIF	8000*8000
BMP	8000*8000

Supported audio format

File extension	Decoder
.3gp	AMR-NB
.aac	AAC
.avi	AAC Dolby AC3 MP3 PCM WMA
.flac	FLAC
.m2ts	AAC Dolby AC3
.mid	MIDI
.mka	Dolby AC3
.mkv	AAC Dolby AC3 DTS
.mp3	MPEG1 Layer1/2/3
.mp4	AAC Dolby E-AC3 MPEG4(AAC)
.ogg	VORBIS
.ts	AAC Dolby E-AC3 DTS MP3 MPEG Audio
.wav	PCM
.webm	WMA V9

Supported subtitle format

ASS MicroDVD
SRT SSA
Subview Vobsub

NOTE

- Video file must meet video format and audio format at the same time, otherwise the file will not be played normally.
- USB 1.1 devices may not be played properly.
- Operation using USB hubs is not guaranteed.
- Video in Motion JPEG format with a resolution higher than 1280x720 may not be played back correctly.
- Some file formats in the above list may not be played back correctly (including images, sounds, subtitles, etc.).
- Depending on the bit rate, some files may not be played back.
- The TV supports DTS encoded video files instead of DTS surround sound formats.
- Some subtitles may not be displayed correctly and this may affect the TV operation.
- Only show the compatible file format.
- According to different files the displayed playback time may be slightly different from the actual.
- The length of time information may not be displayed correctly in some file.

Appendix

Troubleshooting

The problems described below are not always caused by malfunctions. Check the TV again before having the TV serviced.

Problem	Possible solution
<ul style="list-style-type: none"> No power. 	<ul style="list-style-type: none"> Is the AC cord disconnected? (See page 14.) Has the power been turned on? (See page 18.) When the power switch does not work, remove the power plug and insert it again, and press ⏻ (POWER) on the TV after waiting more than five seconds.
<ul style="list-style-type: none"> Unit cannot be operated. 	<ul style="list-style-type: none"> External influences such as lightning, static electricity, etc., may cause improper operation. In this case, operate the unit after first turning the power off or unplugging the AC cord and re-plugging it in after 1 or 2 minutes.
<ul style="list-style-type: none"> Remote control unit does not operate. 	<ul style="list-style-type: none"> Are batteries inserted with polarity (+ , -) aligned? (See page 17.) Are batteries worn out? (Replace with new batteries.)
<ul style="list-style-type: none"> Picture is cut off. 	<ul style="list-style-type: none"> Are screen mode adjustments such as picture size made correctly? (See page 19.)
<ul style="list-style-type: none"> Strange colour, light colour, or dark, or colour misalignment. 	<ul style="list-style-type: none"> Adjust the picture tint. (See page 19.) Is the room too bright? The picture may look dark in a room that is too bright. Check the colour system setting. (See page 21.)
<ul style="list-style-type: none"> Power is suddenly turned off. 	<ul style="list-style-type: none"> The unit's internal temperature has increased. Remove any objects blocking the vent or clean. Is the sleep timer, no signal power off ? (See page 22.)
<ul style="list-style-type: none"> No picture. 	<ul style="list-style-type: none"> Is the connection to external equipment correct? (See pages 15,16 and 27.) Is the correct input selected? (See page 26.) Is the picture adjustment correct? (See page 19.) Is the antenna connected properly? (See page 14.) Check the colour system setting. (See page 21.)
<ul style="list-style-type: none"> No sound. 	<ul style="list-style-type: none"> Is the volume too low? (See page 13.) Check the sound system setting. (See page 21.)
<ul style="list-style-type: none"> The TV sometimes makes a cracking noise. 	<ul style="list-style-type: none"> This is not a malfunction. This happens when the cabinet slightly expands and contracts according to changes in temperature. This does not affect the TV's performance.
<ul style="list-style-type: none"> Cannot select the desired channel. 	<ul style="list-style-type: none"> Switch between Digital TV and Analogue TV modes. (See page 26.)
<ul style="list-style-type: none"> Cannot connect to the Network 	<ul style="list-style-type: none"> Is the LAN cable connected correct. (See pages 24 and 25.) Check the "LAN setting".

Cautions regarding use in high and low temperature environments

- When the unit is used in a low temperature space (e.g. room, office), the picture may leave trails or appear slightly delayed. This is not a malfunction, and the unit will recover when the temperature returns to normal.
 - Do not leave the unit in a hot or cold location. Also, do not leave the unit in a location exposed to direct sunlight or near a heater, as this may cause the cabinet to deform and the LCD panel to malfunction.
- Storage temperature: - 20°C to + 60°C.

Appendix

Specifications

Item		Model	4T-C60AM1H	4T-C70AM1H
Resolution			8,294,400 pixels (3840(H)x 2160(V))	
Video colour system			PAL / SECAM / NTSC 3.58 / NTSC 4.43 / PAL 60	
TV function	TV-Standard	Analogue	PAL:BG, DK, I SECAM:BG,DK NTSC:M	
		Digital	DTMB	
	Receiving channel	VHF/UHF	44.25MHz-863.25 MHz	
		CATV	S1-S41ch (including Hyperband)	
	Digital terrestrial broadcast		52.50MHz-866.00MHz	
STEREO/BILINGUAL		NICAM BG, I, DK ; A2 stereo: BG		
TV tuning system	Analogue		Auto preset 99 channel	
	Digital		Auto preset 999 channel	
Audio amplifier			10Wx2 (L / R)	
Speaker			Φ60mm x 2	
Terminals	Side	USB 1	USB 2.0	
		USB 2	USB 3.0	
		Micro SD	Micro SD card slot	
		HDMI 1	HDMI (HDMI input) (480i, 576i, 480p, 576p, 720p/50Hz, 720p/60Hz, 1080i/50Hz, 1080i/60Hz, 1080p/50Hz, 1080p/60Hz, 1080p/24Hz, 2160p/30Hz) Support for Dolby vision format signals	
		HDMI 2 (ARC)	HDMI (HDMI input) (480i, 576i, 480p, 576p, 720p/50Hz, 720p/60Hz, 1080i/50Hz, 1080i/60Hz, 1080p/50Hz, 1080p/60Hz, 1080p/24Hz, 2160p/30Hz) Support for Dolby vision format signals	
		HDMI 3	HDMI (HDMI input) (480i, 576i, 480p, 576p, 720p/50Hz, 720p/60Hz, 1080i/50Hz, 1080i/60Hz, 1080p/50Hz, 1080p/60Hz, 1080p/24Hz, 2160p/30Hz, 2160p/60Hz) (Support HDR10 for HDMI 3 only. Support for Dolby vision format signals)	
	Rear	ANTENNA	UHF/VHF75 Ω Din type	
		Digital Audio Output	Optical digital audio output	
		COMPONENT/AV INPUT	COMPONENT in (480i, 576i, 480p, 576p, 720p/50Hz, 720p/60Hz, 1080i/50Hz, 1080i/60Hz), AUDIOin ; VIDEO in, AUDIOin	
		Special service terminal	Only for service	
		LAN (ETHERNET10/100)	Network connector	
OSD language			English/Simplified Chinese/Traditional Chinese	
Power requirement			AC 220V, 50Hz	
Power consumption (Standby)			215W (0.5W)	250W (0.5W)
Weight	Without stand		23.0 kg	35.5 kg
	With stand		24.0 kg	36.0 kg
Operating temperature			0 °C to + 45 °C	
<ul style="list-style-type: none"> As a part of policy of continuous improvement, SHARP reserves the right to make design and specification changes for product improvement without prior notice. 				

Appendix

Dimensional drawings

■ 4T-C60AM1H

Unit: mm

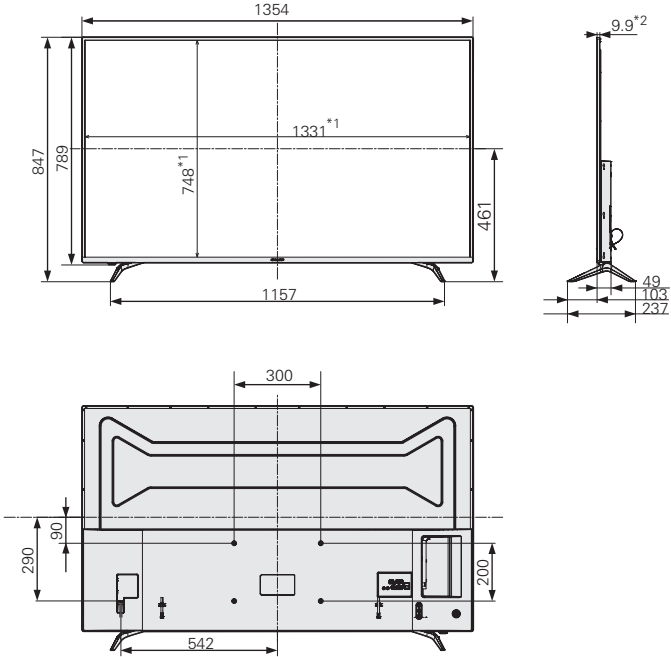

■ 4T-C70AM1H

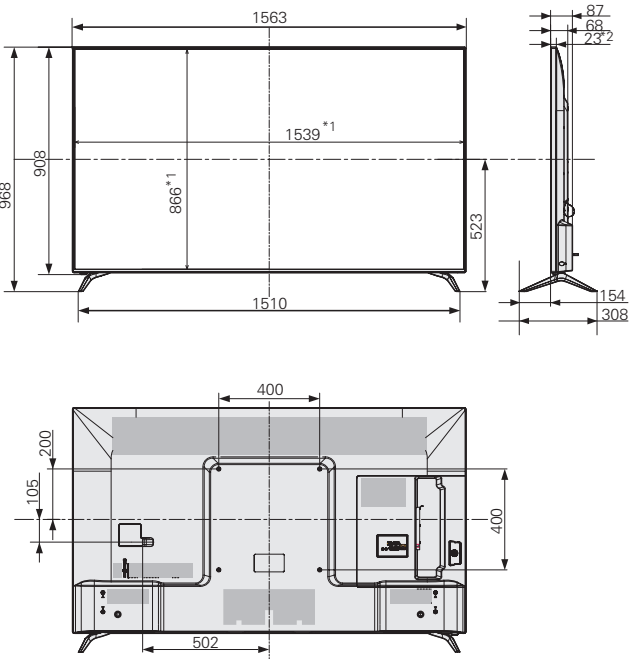

*1 Active area
*2 Thinnest part