

# SHARP®

## FP-H30A



HIGH-DENSITY 7000\*

"Plasmacluster" and "Device of a cluster of grapes" are trademarks of Sharp Corporation.



\*The number in this technology mark indicates an approximate number of ions supplied into air of 1 cm<sup>3</sup>, which is measured around the center of a room with the "high-density plasmacluster 7000" applicable floor area (at 1.2 m height above the floor) at the medium wind volume in air purifying mode, when an air purifier using the high-density plasmacluster ion evolving device is placed close to a wall. This product is equipped with a device corresponding to this capacity.

**Free standing type**  
直立型號

### AIR PURIFIER OPERATION MANUAL

### 空氣清新機 使用說明書

ENGLISH

中文

**香港電器安全規格**  
(國際電工委員會規格適合)

## Please read before operating your new Air Purifier

The air purifier draws in room air from the air intake, passes the air through a Pre-Filter, an Active Carbon Deodorizing Filter and a HEPA Filter inside of the unit, then discharges the air through the air outlet. The HEPA Filter can remove 99.97% of dust particles as small as 0.3 microns that pass through the filter.

The Active Carbon Deodorizing Filter gradually absorbs odors as they pass through the filter.

Some odors absorbed by the filters may break down over time, resulting in additional odor. Depending on the usage environment, especially when the product is used in extreme environments (significantly more severe than normal household use), this odor may become strong in a shorter period than expected. If the odor persists, the filters should be replaced.

### NOTE

- The air purifier is designed to remove air-suspended dust and odor, but not harmful gases (for example, carbon monoxide contained in cigarette smoke).

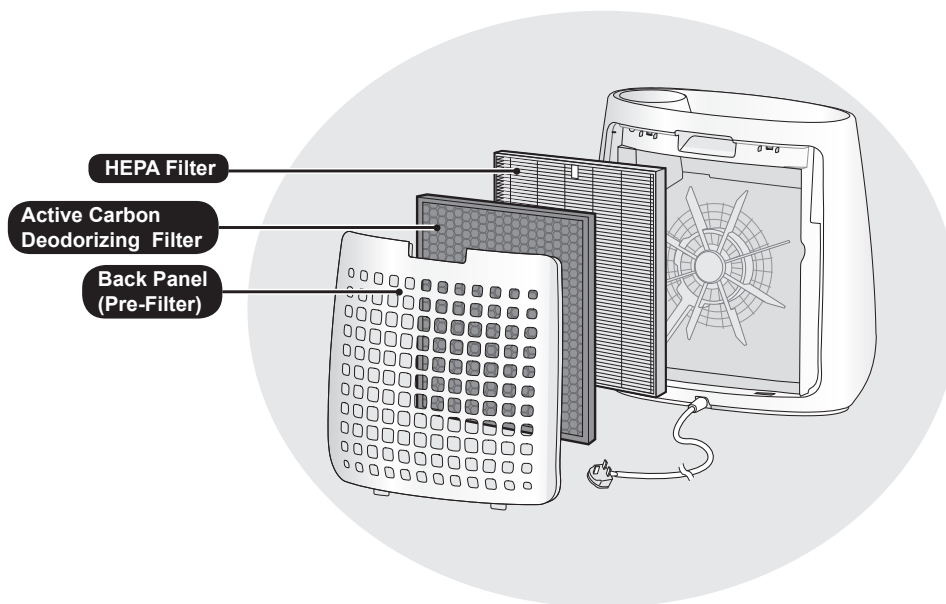

# ENGLISH

## FEATURES

**Unique Combination of Air Treatment Technologies**  
**Triple Filtration System + Plasmacluster Ions**

### **TRAPS DUST\***

Pre-filter traps dust and other large airborne particles.

### **REDUCES ODORS**

Active Carbon Deodorizing filter absorbs many common household odors.

### **REDUCES POLLEN & MOLD\***

HEPA filter traps 99.97% of particles as small as 0.3 microns.

### **FRESHENS**

Plasmacluster treats the air similar to the way nature cleans the environment by emitting a balance of positive and negative ions.

\*When air is drawn through the filter system.

## CONTENTS

<b>IMPORTANT SAFETY INSTRUCTIONS</b> .....	E-2
<b>PART NAMES</b> .....	E-4
<b>FILTER INSTALLATION</b> .....	E-5
<b>OPERATION</b> .....	E-6
<b>CARE AND MAINTENANCE</b> .....	E-8
<b>REPLACEMENT GUIDELINES</b> .....	E-9
<b>TROUBLESHOOTING</b> .....	E-10
<b>SPECIFICATIONS</b> .....	E-11

ENGLISH

---

Thank you for purchasing the SHARP Air Purifier. Please read this manual carefully. Before using this product, be sure to read the section: "Important Safety Instructions." After reading this manual, keep it in a convenient location for future reference. For your reference, we recommend to keep this manual in the place where you can read at any time.

# IMPORTANT SAFETY INSTRUCTIONS

When using electrical appliances, basic safety precautions should be followed, including the following:

**WARNING** - To reduce the risk of electric shock, fire or injury to persons:

- Read all instructions before using the unit.
- Use only a 220 volt outlet.
- **Do not use the unit if the power cord or plug is damaged or the connection to the wall outlet is loosened.**
- Periodically remove dust from the power plug.
- **Do not insert fingers or foreign objects into the intake or air outlet.**
- **When removing the power plug, always hold the plug and never pull the cord.** Electric shock and/or fire from short circuit may occur as a result.
- Be careful not to damage the power cord, it may cause electric shock, excess heat or fires.
- **Do not remove the plug when your hands are wet.**
- **Do not use this unit near gas appliances or fireplaces.**
- **Remove the power plug from the wall outlet before cleaning the unit and when not using the unit.** Electric shock from bad insulation and/or fire from short circuit may occur as a result.
- When cleaning the unit, or when the unit is not in use, be sure to unplug the unit. Electric shock and/or fire from a short circuit may result.
- **If the power cord is damaged, it must be replaced by the manufacturer, its service agent, Sharp Authorized Service Center or similarly qualified person in order to avoid a hazard.**
- Do not operate when using aerosol insecticides or in rooms where there is oily residue, incense, sparks from lit cigarettes, chemical fumes in the air or in very high humidity conditions, such as a bathroom.
- Be cautious when cleaning the unit. Corrosive cleansers may damage the exterior.
- Only a Sharp Authorized Service Center should service this air purifier. Contact the nearest Service Center for any problems, adjustments, or repairs.
- This appliance is not intended for use by persons (including children) with reduced physical, sensory or mental capabilities, or lack of experience and knowledge, unless they have been given supervision or instruction concerning use of the appliance by a person responsible for their safety. Children shall not play with the appliance. Cleaning and user maintenance shall not be made by children without supervision.

**NOTE** - Radio or TV Interference

If this air purifier should cause interference to radio or television reception, try to correct the interference by one or more of the following measures:

- Reorient or relocate the receiving antenna.
- Increase the separation between the unit and radio/TV receiver.
- Connect the equipment into an outlet on a circuit different from that to which the receiver is connected.
- Consult the dealer or an experienced radio/TV technician for help.



## CAUTIONS CONCERNING OPERATION

- Do not block the air intake and/or air outlet.
- Do not use the unit near or on hot objects, such as stoves or heaters or where it may come into contact with steam.
- Do not lay the unit down when using.
- **Always hold the handle on the back of the unit when moving it.**
- Do not use without the filters installed inside the unit.
- **Do not wash and reuse the HEPA filter and the Active Carbon Deodorizing filter.**  
Not only does it not improve filter performance, it may cause electric shock or malfunction.

## INSTALLATION GUIDELINES

- **When using the unit, place it away from equipment utilizing electric waves such as televisions or radios to avoid electrical interference.**
- **Avoid using in locations where furniture, fabrics or other items may come in contact with and restrict the air intake and/or air outlet.**
- **Avoid using in locations where the unit is exposed to condensation or drastic temperature changes. Appropriate condition is at room temperature 0 – 35 °C.**
- **Place on a stable surface with sufficient air circulation.**  
When placing the unit on a heavily carpeted area, the unit may vibrate slightly.
- **Avoid locations where grease or oily smoke is generated.**  
The unit surface may crack as a result.
- **Place the unit about 30 cm(1 ft) away from the wall in order to ensure proper airflow.**  
The dust collecting performance will be the same even if using the unit 3cm away from the wall, but place it as far as possible(30cm away recommended) because it may dirty the wall or floor around.

## FILTER GUIDELINES

- Follow the instructions in this manual for correct care and maintenance of the filter.

# PART NAMES

## FRONT

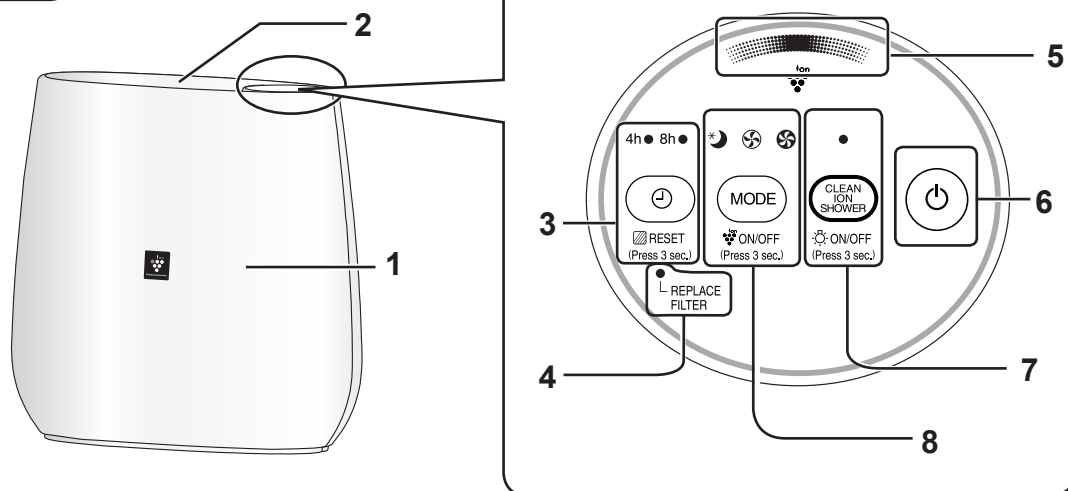

## BACK

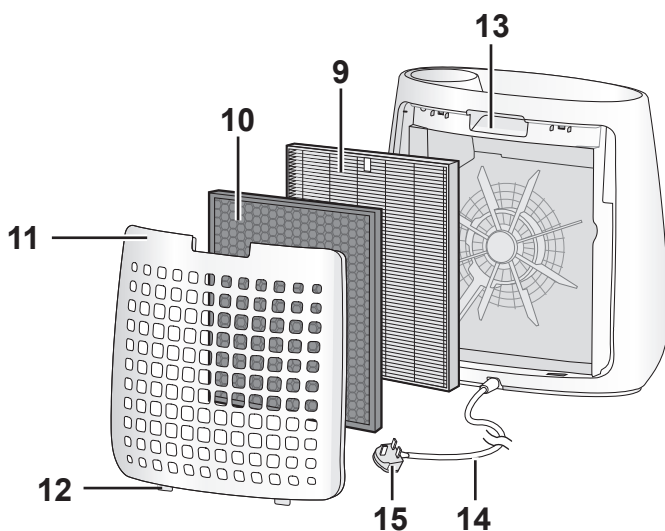

1	Main Unit	8	MODE Button, Indicator Light (green)
2	Air Outlet	8	Plasmacluster Ion ON/OFF Button (Press 3 sec.)
3	OFF TIMER Button, Indicator Light (green) Filter Reset Button (Press 3 sec.)	9	HEPA Filter
4	Replace Filter Indicator Light (orange)	10	Active Carbon Deodorizing Filter
5	Plasmacluster Ion Indicator Light (blue)	11	Back Panel (Pre-Filter)
6	POWER ON/OFF Button	12	Bottom Tabs
7	CLEAN ION SHOWER Button, Indicator Light (green) LIGHT ON/OFF Button (Press 3 sec.)	13	Handle
		14	Power Cord
		15	Plug

# FILTER INSTALLATION

Be sure to remove the power plug from the wall outlet.

To maintain the quality of the filter, it is installed in the main unit and packed in plastic bag. Be sure to remove the filter from the plastic bag before using the unit.

ENGLISH

## 1 Remove the Back Panel.

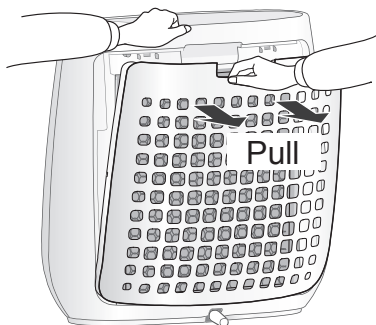

## 2 Remove the plastic bag from the Filter.

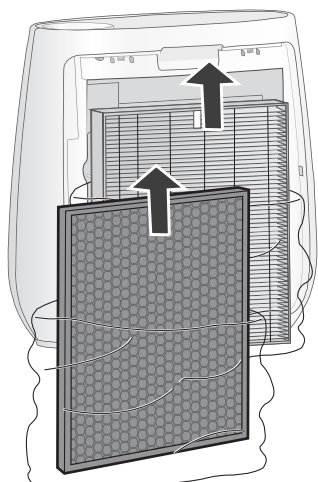

## 3 Place the Filter within the main unit.

Do not install the filter backwards or the unit will not operate properly.

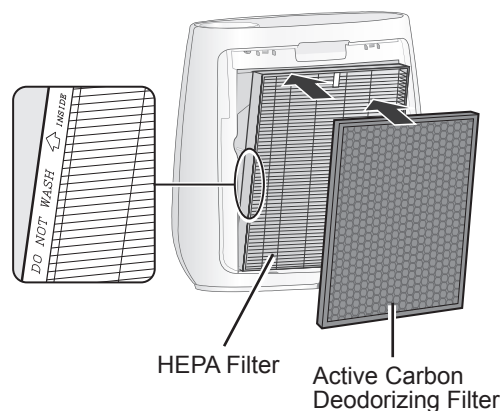

## 4 Replace the Back Panel to the main unit.

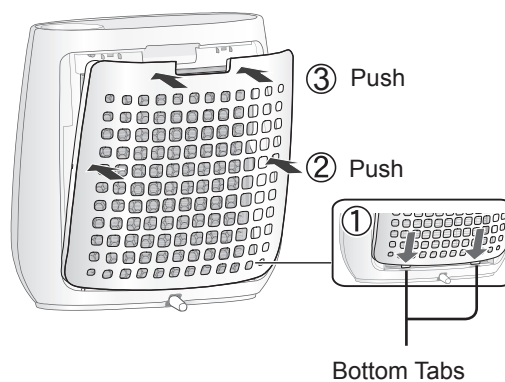

• Do not operate the unit without the filter.

# OPERATION

## CLEAN AIR

### START

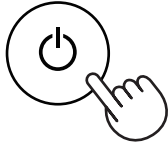

### STOP

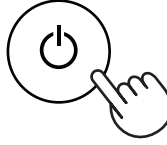

- Select the desired fan speed.
- Unless the power cord has been unplugged, the operation starts in the previous mode it was operated in.

## CLEAN ION SHOWER

Releases high-density Plasmacluster Ions and discharges strong air flow for 60 minutes.

### START



### NOTE

- When the operation finishes, the unit will return to the prior operation mode. It is able to change the other mode and  during this mode.
- If Plasmacluster Ion is OFF, Plasmacluster Ion will not be released.

## FAN SPEED

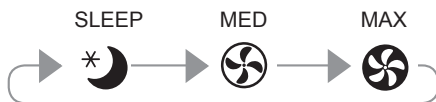

### NOTE

#### SLEEP \*

- The unit will operate very quietly with low fan speed. Plasmacluster Ion Indicator goes off automatically. Even though the indicator is off, Plasmacluster Ion is released into air unless Plasmacluster Ion is turned off by .

 ON/OFF  
(Press 3 sec.)

## OFF TIMER

Select the time turning off the unit during operation. The unit automatically stops once the selected time is reached.

4h ● 8h ●

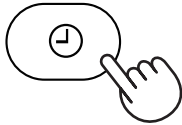

## Light Control

You can set the Plasmacluster Ion Indicator to OFF when the Plasmacluster Ion Indicator is bright.

**ON**

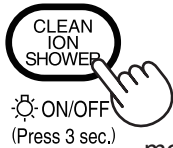

more than 3 sec.



**OFF**

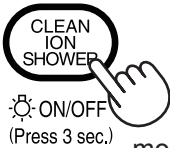

more than 3 sec.

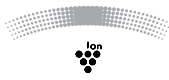

### NOTE

- When the unit restarts its operation, Light Control resumes its setting set before turning off.

## Plasmacluster Ion ON/OFF

When Plasmacluster Ion is ON, the Plasmacluster Ion Indicator Light will turn on. (blue)

**ON**

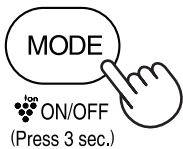

more than 3 sec.

**OFF**

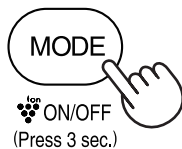

more than 3 sec.

### NOTE

When Indicator is off,

- If Plasmacluster Ion is ON,

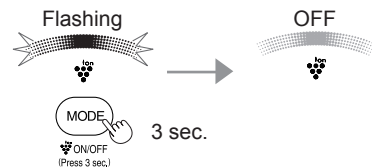

- If Plasmacluster Ion is OFF,

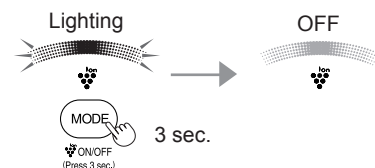

# CARE AND MAINTENANCE



To maintain optimum performance of this air purifier, please clean the unit including the filter periodically.  
Be sure to disconnect the power cord from the wall outlet before performing any maintenance.

## Back Panel (Pre-filter)

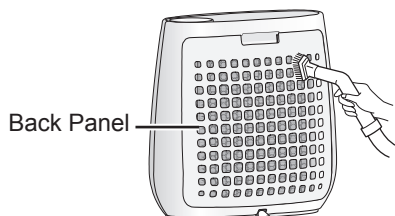

Gently remove dust from the back panel by using a vacuum cleaner attachment or similar tool.

### CAUTION

Do not apply excessive pressure when scrubbing the back panel.

### NOTE How to clean stubborn dirt

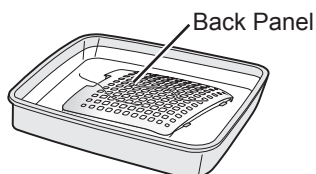

1. Add a small amount of kitchen detergent to water and soak for about 10 minutes.
2. Rinse off the kitchen detergent with clean water.
3. Completely dry the filter in a well-ventilated area.

## Filters

### HEPA Filter

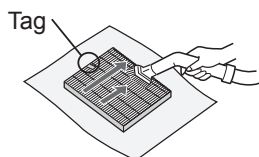

Gently remove dust from the HEPA FILTER and Active Carbon Deodorizing Filter with a vacuum cleaner attachment or similar tool.

### CAUTION

Do not WASH in water and DRY in the sun.  
The filters are fragile, be careful not to apply too much force.

### Active Carbon Deodorizing Filter

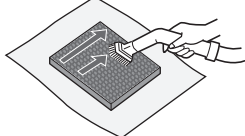

- HEPA Filter  
Apply the maintenance only on the side with the tag.  
Do not clean the opposite side; otherwise, the filter will be damaged.
- Active Carbon Deodorizing Filter  
The maintenance can be applied to the both sides.

## Unit



### Wipe with a dry, soft cloth

For stubborn stains or dirt, use a soft cloth dampened with warm water.

### CAUTION

- Do not use volatile fluids  
Benzene, paint thinner, polishing powder, etc. , may damage the surface.
- Do not use detergents  
Detergent ingredients may damage the unit.

# REPLACEMENT GUIDELINES



## Filter

### Replacement timing

When Replace Filter Indicator light turn on\*

#### HEPA Filter

Model : FZ-F30HFE

#### Active Carbon Deodorizing Filter

Model : FZ-F30DFE-HK

Replace the Filter according to the instructions provided with the replacement filter.

After the exchange, insert the plug in socket and press the POWER button, and OFF TIMER button 3 seconds.

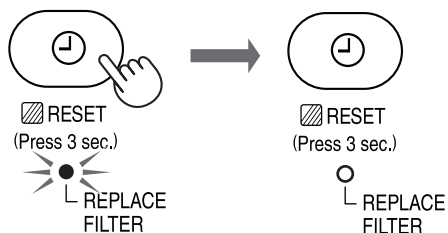

\*The Replace Filter indicator light will turn on after approximately 17,500 hours in Sleep mode.  
( 2 years × 24 hours = 17,500)  
Filter life varies depend on the operation mode.

### Do not wash and reuse the filter

The filter life and replacement period are based on the condition of smoking 5 cigarettes per day and the dust collection power is reduced by half compared with that of new filter.

Filter life varies depending on the room environment, usage, and location of the unit. We recommend to replace the filter more frequently if the product is used in a condition significantly severer than normal household use.

- Please consult your dealer for purchase of replacement filter.
- Use only filter designed for this product.

### Disposal of Filter

Please dispose of the replaced filter according to the local disposal laws and regulations.

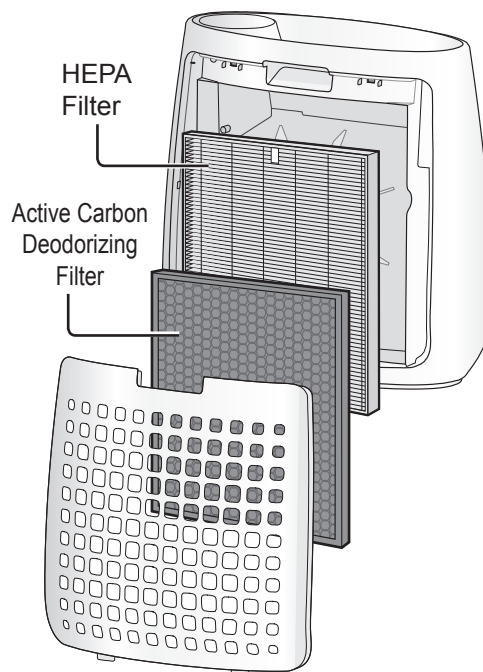

HEPA Filter materials:	Active Carbon Deodorizing Filter materials:
•Filter : Polypropylene	• Polypropylene • Polyester
•Frame : Polyester	• Activated charcoal



ENGLISH

# TROUBLESHOOTING



Before calling for service, please review the troubleshooting list below, since the problem may not be a unit malfunction.

SYMPTOM	REMEDY (not a malfunction)
<b>Dust and smoke are not removed.</b>	<ul style="list-style-type: none"> <li>• Clean or replace the filter if they appear to be heavily soiled. (Refer to E-8,E-9)</li> </ul>
<b>A clicking or ticking sound is heard from the unit.</b>	<ul style="list-style-type: none"> <li>• Clicking or ticking sound may be audible when the unit is generating ions. (Refer to E-7)</li> </ul>
<b>The discharged air has an odor.</b>	<ul style="list-style-type: none"> <li>• Check to see if the filter are heavily soiled. Replace the filter.</li> <li>• Plasmacluster Air Purifiers emit small traces of ozone which may produce an odor. These ozone emissions are well below safety level.</li> </ul>
<b>The Plasmacluster Ion Indicator doesn't Light on.</b>	<ul style="list-style-type: none"> <li>• Check to see if the SLEEP mode is selected. The Plasmacluster Ion Indicator Light is turned off 3 seconds after the SLEEP mode is selected.</li> <li>• Check to see if the Plasmacluster Ion OFF is selected. Press  for 3 seconds to light On. <small>ON/OFF (Press 3 sec.)</small></li> <li>• Check to see if the Light Control OFF is selected. Press  for 3 seconds to light On. <small>ON/OFF (Press 3 sec.)</small></li> </ul>
<b>AUTO RESTART</b>	<ul style="list-style-type: none"> <li>• Even when the plug is unplugged or the breaker is thrown during operation, the unit resumes at the previous operation mode and settings if the power recovers.</li> </ul>

**OFF**  
(with the unit OFF)





(simultaneously for more than 3 sec.)

If the , ,  lights flashes for 3 seconds, the setting is 'OFF'.

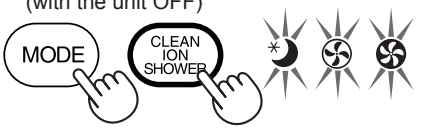
**ON(default)**  
(with the unit OFF)



(simultaneously for more than 3 sec.)

If the , ,  lights Lights up for 10 seconds, the setting is 'ON'.



# SPECIFICATIONS

ENGLISH

Power Supply		220V 50Hz		
Fan Speed Operation	Fan Speed	MAX	MED	SLEEP
	Rated Power (W)	50	30	13
	Airflow (m <sup>3</sup> /hr)	180	120	60
Applicable Floor Area (m <sup>2</sup> ) *1		~22		
High density Plasmacluster ion recommended room size (m <sup>2</sup> ) *2		~16		
Cord Length (m)		2.0		
Dimensions (mm)		431(W) x 211(D) x 411(H)		
Weight (kg)		4.2		

- \*1 Size of a room which is appropriate for operating the unit at maximum fan speed.
- It indicates the space where a certain amount of dust particles can be removed in 30 minutes (JEM1467).
- \*2 Size of a room in which approximately 7000 ions can be measured per cubic centimeter in the center of the room (at a height of approximately 1.2 meters from the floor) when the product is placed next to a wall and run at the MED operation position.

## Standby Power

In order to operate the electrical circuits while the power plug is inserted in the wall outlet, this product consumes about 0.6W of standby power. For energy saving, unplug the power cord when the unit is not in use.

## 操作您的新空氣清新機之前，請詳細閱讀本手冊

空氣清新機從進氣口吸入室內空氣，讓空氣通過預濾網及主機內的活性炭除臭過濾網和 HEPA 過濾網，然後將淨化後的空氣由出風口排出。HEPA 過濾網可以去除 99.97% 穿過過濾網的約 0.3 微米的灰塵。而活性炭除臭過濾網則會吸除異味。

過濾網吸附的異味隨著時間可能會再次分解並散發出來，從而產生其他異味。視乎不同的使用環境，尤其是產品應用於極端環境下（比家居使用環境嚴重），這些異味可能在比預期更短的時間內變得更濃烈。如果異味持續存在，請更換過濾網。

### 注意

- 本空氣清新機用於去除空氣中懸浮的灰塵和異味，而不能去除有害氣體（如：香煙煙霧中的一氧化碳）。

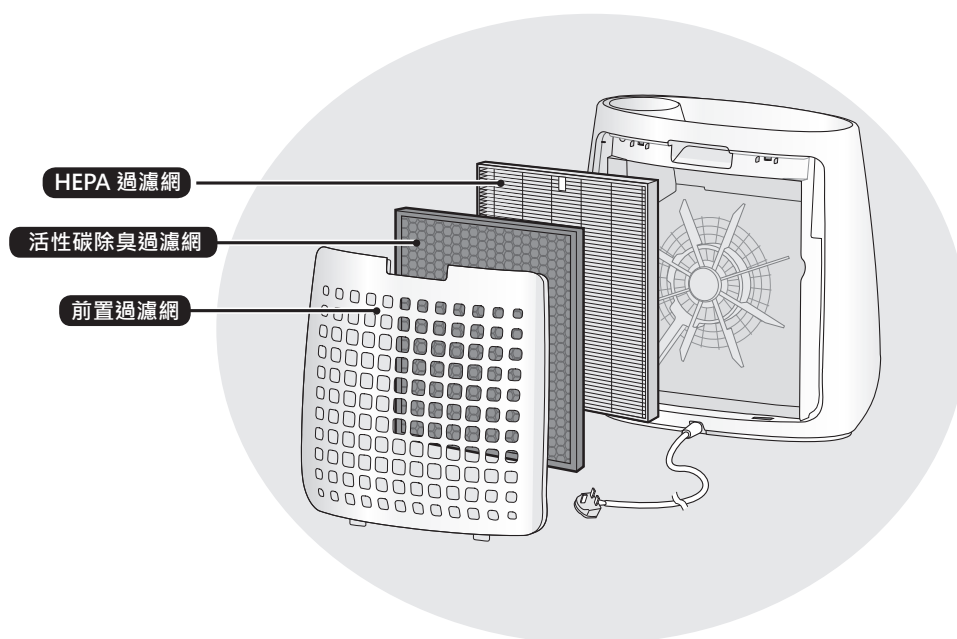

## 特點

**獨有多重空氣淨化技術  
三重過濾網系統及 Plasmacluster Ions**

### 去除灰塵\*

前置過濾網去除灰塵及其他較大的空氣粒子。

### 去除異味

活性炭除臭過濾網能去除一般垃圾異味。

### 去除花粉與霉菌\*

HEPA 過濾網可去除 99.97% 約 0.3 微米的微塵粒子。

### 淨化空氣

正如大自然潔淨環境的原理一樣，Plasmacluster Ions 在淨化空氣的同時，釋放出數量相等的正離子和負離子來淨化空氣。

\* 空氣經過過濾網系統，然後再排出。

## 目錄

重要安全事項.....	C-2
各部份名稱.....	C-4
安裝過濾網.....	C-5
主機操作.....	C-6
日常保養.....	C-8
過濾網更換指南.....	C-9
故障時的檢查事項.....	C-10
規格.....	C-11

感謝您購買 SHARP 空氣清新機。請仔細閱讀本說明書。使用本產品之前，請務必閱讀“重要安全事項”一節。  
閱讀後請妥善保存本說明書，以便日後查閱。我們建議將本說明書保存於方便隨時查閱的地方。

# 重要安全事項

在使用電器產品時，必須遵守基本安全預防措施，包括以下各方面：

**警告** - 為了減少觸電、火災或受傷等危險：

- 使用本機前，請先閱讀說明書。
- 僅使用 220 伏特電源插座。
- 在電源線或電源插頭發生損壞、或是牆壁上的電源插座發生鬆脫的情況下，切勿使用本機。
- 請定期清除電源插頭上的灰塵。
- 請勿將手指或異物插入進氣口或出風口。
- 移除電源插頭時，請務必抓住插頭而不要拉扯電源線。  
否則可能會由於短路而導致觸電或發生火災。
- 請注意不要損壞電源線，否則可能導致觸電、過熱或發生火災。
- 切勿在手濕時移除電源插頭。
- 切勿在氣體設備或壁爐附近使用本機。
- 清潔或不使用本機時，將電源線從牆壁的插座上拔出。  
否則可能會由於短路而導致觸電、隔熱不良和 / 或發生火災。
- 清潔或不使用本機時，請確保拔出主機的插頭。否則可能會由於短路而導致觸電或發生火災。
- 如果電源線損壞，必須由製造廠商、其服務代理商、聲寶公司授權服務中心或其他具有同樣資格的人員進行更換，以避免發生危險。
- 使用噴霧殺蟲劑或房間中有含油殘餘物、焚香、點燃香煙的火花、空氣中有化學煙霧或在非常潮濕的環境（如浴室）中時，請勿使用本機。
- 清潔本機時請注意。腐蝕性清潔劑可能會損壞外殼。
- 只有聲寶公司授權服務中心可以對本空氣清新機進行維修。若本機出現任何問題、需要調校或修理，請聯絡最近的服務中心。
- 除非得到監護人或負責其安全人士的適當監督或指導，否則，本機不適合身體官能或心智能力退化者，或缺乏操作經驗和知識的人士（包括兒童）使用。本機不應該作為兒童的玩具。在沒有監督的情況下，兒童不應對本機進行清潔保養。

**注意** — 收音機或電視機干擾

如果本空氣清新機對收音機或電視接收造成干擾，請嘗試以下列其中一項或多項措施修正干擾：

- 改變接收天線的方向或擺放位置。
- 增加本機與收音機 / 電視機接收器之間的距離。
- 將本機與接收器分別連接至不同的電源插座或供電線路。
- 向經銷商或有經驗的收音機 / 電視機技術人員諮詢並請求幫助。

## 操作的注意事項

- 切勿堵塞進氣口和 / 或出風口。
- 請勿靠近或在熱源物體上（如爐灶、暖爐或散熱器），或者在可以接觸到蒸氣的地方使用本機。
- 使用時，請勿平放本機。
- **移動本機時，請緊握主機背部的手柄。**
- 請勿在沒有安裝過濾網的情況下使用本機。
- **請勿清洗和重複使用 HEPA 過濾網和活性碳除臭過濾網。**  
這樣不但不會提高過濾網效能，反而可能引致觸電或機件故障。

## 安裝指南

- 使用本機時，請遠離發出電波的設備（例如電視機或收音機），以避免產生電波干擾。
- 避免在家具、織物或其他用品可能會與進氣口和 / 或出風口接觸的地方使用本機。
- 請勿在溫差極大或導致本機直接暴露於冷凝環境的地方使用。適當的使用環境是 0 - 35 °C 的室溫環境。
- **安裝必須穩固，且通風良好。**  
把本機放置在鋪有厚地毯的地方時，可能導致本機微微震動。
- **請避免在產生油煙的地方使用本機。**  
否則本機外殼可能會裂開。
- **請將本機放置於距離牆壁大約 30 cm (1 ft) 的位置，以確保適當氣流流動。**  
與牆壁保持 3cm 距離即可確保除塵性能，但仍然應該儘量遠離牆壁（建議 30cm），因為本機可能會把周圍的牆壁或地板弄髒。

## 過濾網指南

- 請遵循本說明書的指示，正確保養和維護過濾網。

# 各部份名稱

## 前面

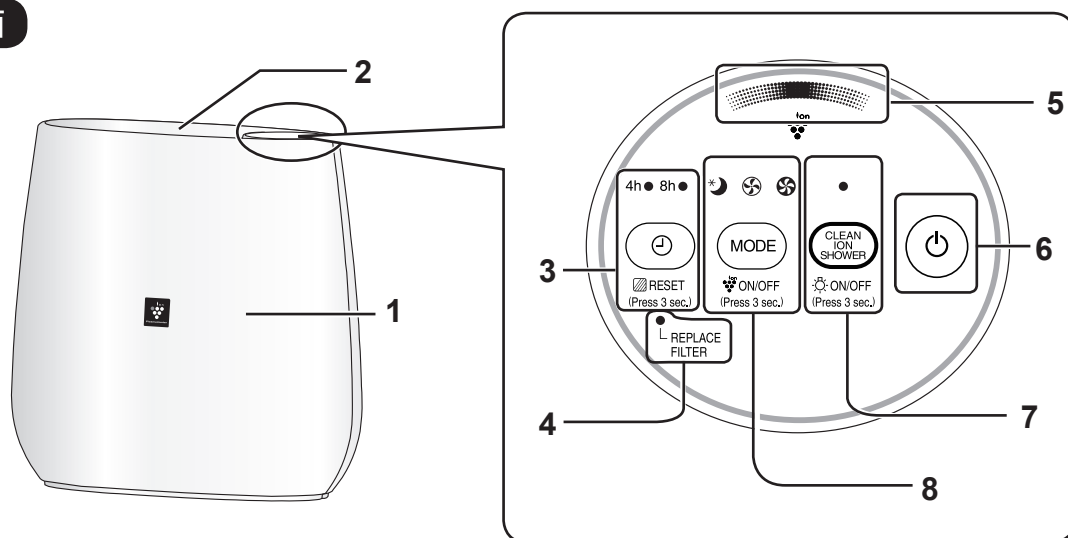

## 背面

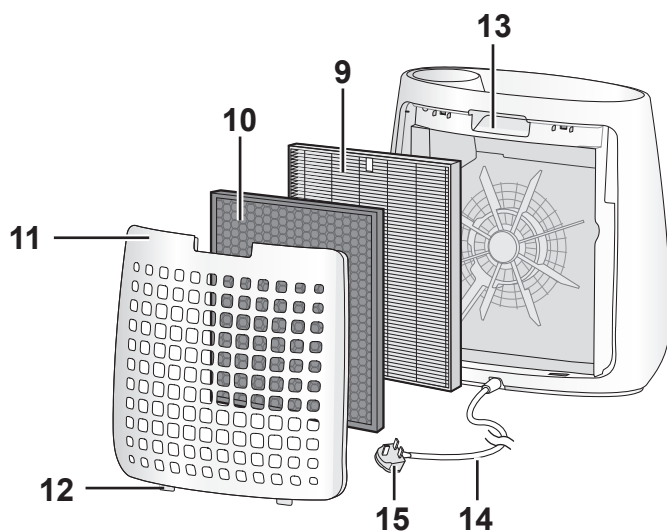

1	主機	8	MODE(模式)按鈕 / 指示燈 (綠色) Plasmacluster Ion 開 / 關按鈕 (按住 3 秒)
2	吹出口	9	HEPA 過濾網
3	關機定時器按鈕 / 指示燈 (綠色) Filter Reset 按鈕 (按住 3 秒)	10	活性碳除臭過濾網
4	Replace Filter 指示燈 (橙色)	11	前置過濾網 (背板)
5	Plasmacluster Ion 指示燈 (藍色)	12	下扣勾
6	電源 (開 / 關) 按鈕	13	手柄
7	CLEAN ION SHOWER (強力 Ion 除菌) 按鈕 / 指示燈 (綠色) 指示燈 (開 / 關) 按鈕 (按住 3 秒)	14	電線
		15	插頭

# 安裝過濾網

確保將電源線從牆壁的插座上拔出。

為確保過濾網的品質，過濾網以塑膠袋包裝並安裝在主機中。  
使用本機前，須將過濾網從塑膠袋中取出。

## 1 取下前置過濾網（背板）。

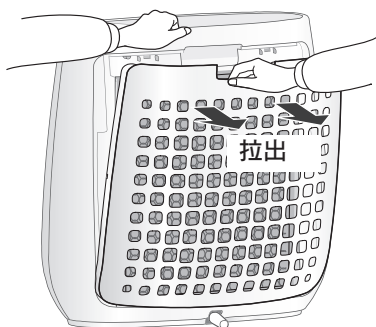

## 2 將過濾網從塑膠袋中取出來。

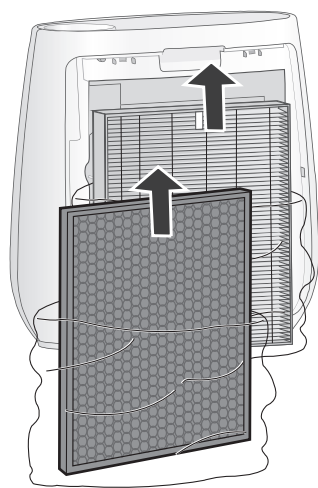

## 3 將過濾網安裝到主機中。

請勿反向安裝過濾網，否則本機無法正常操作。

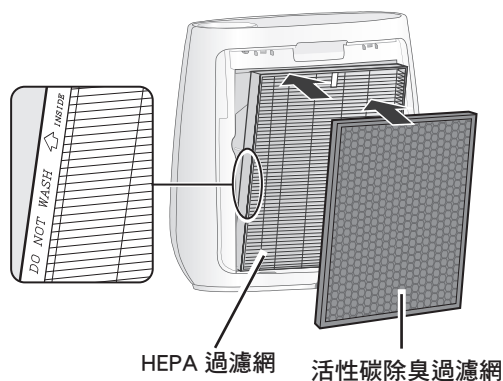

## 4 將前置過濾網（背板）裝回主機。

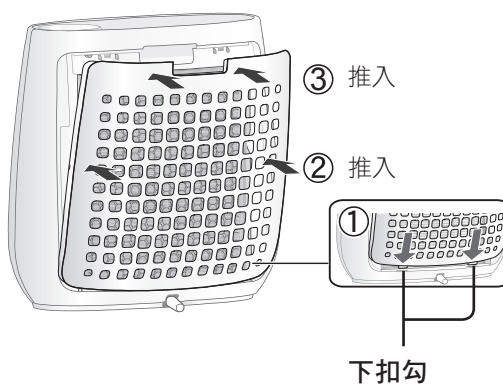

· 請勿在沒有安裝過濾網的情況下操作本機。

文  
中

# 主機操作

## 空氣淨化

啟動

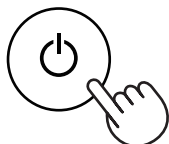

停止運轉

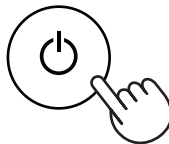

- 選擇所需的風速。
- 除非拔掉電源，否則主機啟動後將維持前一次的操作模式。

## 強力 Ion 除菌

持續 60 分鐘於高風速釋放高濃度 Plasmacluster Ions。

啟動



### 注意

- 此操作完成時，主機會恢復到之前的操作模式。  
本機能在此模式下轉換成其他模式或  停止操作。
- 如果 Plasmacluster Ion 為「關」，將不再釋放出離子。

## 風速

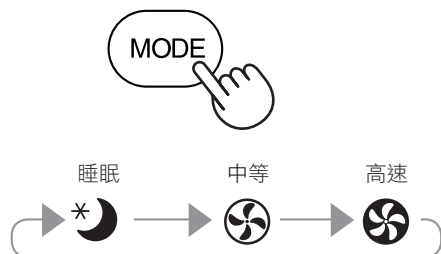

### 注意

#### 睡眠模式 \*

- 本機在使用睡眠模式時操作非常寧靜。  
PLASMACLUSTER 指示燈及淨化度指示燈自動熄滅。  
即使指示燈關閉後，離子仍然釋放至空氣中，  
除非按下  關閉 Plasmacluster Ion。

 ON/OFF  
(Press 3 sec.)



## 關機定時器

在主機啟動下，選擇關機時間。到達所選時間後，主機操作自動停止。

4h ● 8h ●

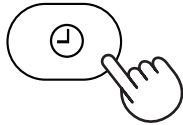

## 指示燈開 / 關

PLASMACLUSTER 指示燈及淨化度指示燈亮起時，您可以將指示燈設定為「關」。

開



ON/OFF  
(Press 3 sec.)

超過 3 秒。

關



ON/OFF  
(Press 3 sec.)

超過 3 秒。

注意

• 設備重新啟動時，Light Control (燈光控制) 繼續執行之前的燈光設置。

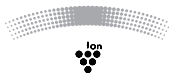

## Plasmacluster Ion 開 / 關

Plasmacluster Ion 為「開」時，PLASMACLUSTER 指示燈將亮起。(藍色)  
(運行中)

開

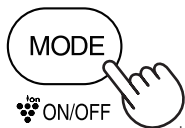

ON/OFF  
(Press 3 sec.)

超過 3 秒。

關

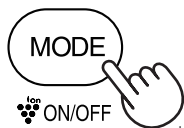

ON/OFF  
(Press 3 sec.)

超過 3 秒。

注意

指示燈關閉時，

• 關閉 Plasmacluster Ion，

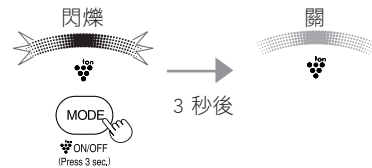

• 開啟 Plasmacluster Ion，

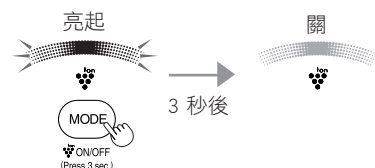

# 日常保養



為保持本空氣清新機的最佳性能，請定期清潔本機（包括過濾網）。  
在進行清潔保養之前，務必將電源插頭從牆壁的插座上拔出。

## 前置過濾網（背板）

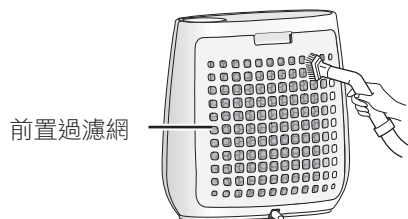

使用吸塵機或其他類似工具，輕輕清除前置過濾網上的灰塵。

### 警告

吸掃前置過濾網時，請勿使用過大力度。

### 注意 如何清潔難以去除的污垢

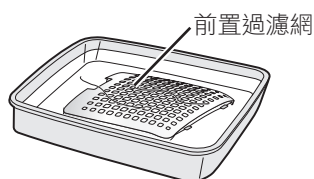

1. 添加少量的廚房清潔劑至水中，浸泡大約 10 分鐘。
2. 使用清水沖洗乾淨。
3. 將過濾網放到通風良好的地方使其徹底晾乾。

## 過濾網

HEPA 過濾網

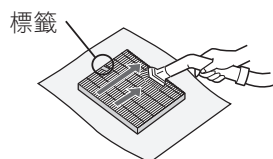

使用吸塵器小心地清除 HEPA 過濾網及活性炭除臭過濾網上的灰塵。

### 警告

請勿水洗和在陽光下晾曬。

活性炭除臭過濾網

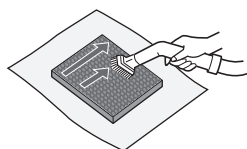

- HEPA 過濾網  
只清潔帶標籤的一面。  
請勿清潔另一面，否則將損害過濾網的性能。  
過濾網較為脆弱，請小心清潔，務必注意不要用力過度。
- 活性炭除臭過濾網  
兩面都可以進行清潔保養。  
過濾網較為脆弱，請小心清潔，務必注意不要用力過度。

## 主機



### 使用柔軟乾布擦拭

對於頑固污漬，請使用一塊溫水浸泡過的軟布擦拭。

### 警告

- 請勿使用揮發性的液體  
使用苯、油漆稀釋劑以及打臘粉等可能會損壞主機表面。
- 請勿使用清潔劑  
清潔劑成分可能會損壞主機。

# 過濾網更換指南



## 過濾網

更換時間 當 **Replace Filter** 指示燈亮起時 \*

**HEPA 過濾網**

型號：FZ-F30HFE

**活性炭除臭過濾網**

型號：FZ-F30DFE-HK

按照更換用的過濾網隨附的說明更換過濾網。

更換後，將插頭插入插槽，按下電源按鈕，然後按關機定時器按鈕 3 秒鐘。

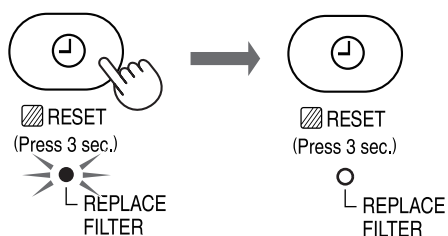

\*Replace Filter 指示燈將在使用睡眠模式下約 17500 小時後亮起 (2 年 x 24 小時 = 17500)

根據操作模式不同，過濾網壽命有所區別。

### 請勿清洗和重複使用過濾網

過濾網的壽命與更換週期是根據每天燃點 5 支香煙，而集塵及吸除異味效能比新過濾網減少一半來計算。

過濾網壽命視乎使用的房間環境、時間長短和空氣清新機的位置而定。

如果本機用於比普通家庭污染更嚴重的環境，我們建議您更加頻繁更換過濾網。

- 請諮詢您的經銷商了解更多關於購買更換用過濾網的資訊。
- 請僅使用為本機設計的過濾網。

### 棄置過濾網

請按照您所在地區的廢物處置法律和條例，處理使用過的過濾網。

HEPA 過濾網材料：

- 過濾網：聚丙烯
- 外框：聚酯

活性炭除臭過濾網材料：



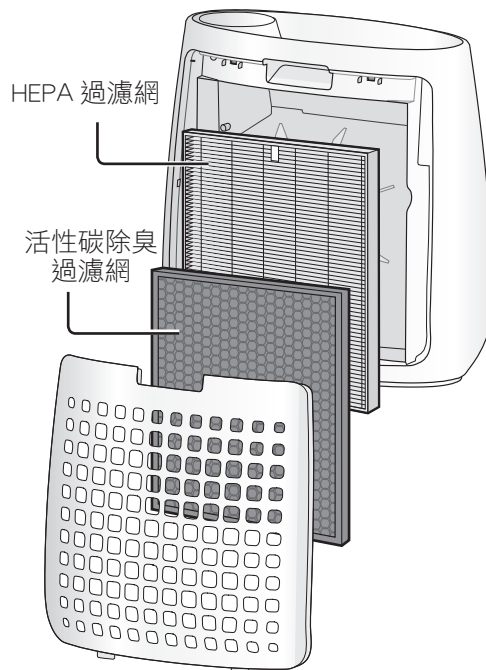

- 聚丙烯、聚酯、活性炭



中文

# 故障時的檢查事項



在委託維修之前，請先查看下面的處理方法。有些問題可能不代表本機故障。

問題	處理方法（並非故障）
難以去除灰塵及煙霧。	<ul style="list-style-type: none"> <li>如果過濾網很髒，請清潔或更換。（請參閱 C-8,C-9）</li> </ul>
主機發出喀嚓 / 滴答聲。	<ul style="list-style-type: none"> <li>本機釋放離子時可能會產生滴答聲。（請參閱 C-7）</li> </ul>
排出的空氣有異味。	<ul style="list-style-type: none"> <li>檢查過濾網是否已很髒。</li> <li>請清潔或更換過濾網。</li> <li>Plasmacluster Ion 空氣清新機釋放出少量的臭氧，從而發出異味。釋放的臭氧量在安全水平以下。</li> </ul>
Plasmacluster Ion 指示燈沒有亮起。	<ul style="list-style-type: none"> <li>檢查是否選擇了「睡眠」模式。 選擇「睡眠」模式 3 秒後，Plasmacluster Ion 指示燈關閉。</li> <li>檢查是否選擇了 Plasmacluster Ion 「關」狀態。 按下  使其亮起。  (Press 3 sec.)</li> <li>檢查是否選擇了「指示燈控制」。按下  3 秒鐘後亮起。  (Press 3 sec.)</li> </ul>
自動重新啟動	<ul style="list-style-type: none"> <li>即使在操作過程中，電源遭拔除或受到中斷，待重新供電後將恢復之前的操作模式。</li> </ul>

**關**  
(機器在關閉狀態下)



(同時按下 3 秒鐘以上)



若 , ,  燈閃爍 10 秒鐘，便完成

↔

**開 (default)**  
(機器在關閉狀態下)



(同時按下 3 秒鐘以上)

若 , ,  燈亮起 10 秒鐘，便完成

# 規格

電源		220V 50Hz		
風速 操作	風速	高	中	睡眠
	耗電量 (瓦)	50	30	13
	空氣流量 (立方米 / 小時)	180	120	60
適用面積 (平方米)*1		~22		
高濃度 Plasmacluster Ion 適用面積 (平方米)*2		~16		
電線長度 (米)		2.0		
尺寸 (毫米)		431(W) x 211(D) x 411(H)		
重量 (公斤)		4.2		

\*1 本機運行最大風速的適用面積。

· 它指示了在 30 分鐘內移除一定數量塵粒的面積 (JEM1467)。

\*2 當本機放置在牆壁旁邊，且使用 MED (中風速) 運作模式時，在房間中間 (約為 1.2 米的高度) 每立方厘米大約可以測量到 7000 粒離子的房間面積。

**備用耗電量** 為了電路操作，當電源插頭插入牆壁的電源插座時，本產品會消耗 0.6 瓦的備用耗電量。  
為了節約用電，請於不使用本機時移除電源插頭。

中文

# MEMO

---

# MEMO

---

**SHARP**  
**SHARP CORPORATION**  
**OSAKA, JAPAN**

Printed in Thailand  
TINS-B104KKRZ 18A- ①