

# SHARP

# MX-3560N MX-3060N

Digital Full Colour Multifunctional System



## Streamlined and Future-Ready Document Solutions



simply better **business**

# Next-Generation MFPs for Simply Better **Business**

Sharp's next-generation full-colour MX-3560N/3060N MFPs are packed with state-of-the-art technologies that add new value to your workflow. Thanks to the user-friendly design of these MFPs—including a new Easy UI mode—a wide variety of users can access their advanced functions easily and intuitively. Adding one of these high performers to your talent pool is a great way to make your business grow.



Home screen



Easy Copy mode



Easy Scan mode

## Simply Better **Process**

Business owners / directors

*Transform the way you use information in your business by connecting one of these new MFPs to a variety of mobile devices and cloud services. Now you don't have to be confined to the office—you and your team can work anytime, anywhere. The amazing flexibility of these Sharp MFPs can help you grab new business opportunities and boost your bottom line.*



### Link to Public Cloud and Mobile Printing Services\*

These MFPs enable single sign-on for easy access to public cloud services such as Google Drive™, OneDrive® for Business, and SharePoint® Online. They also support various mobile printing services\* such as Google Cloud Print™, AirPrint, Mopria™, and Sharp Print Service Plugin.

\* For details, see page 5 and 6.

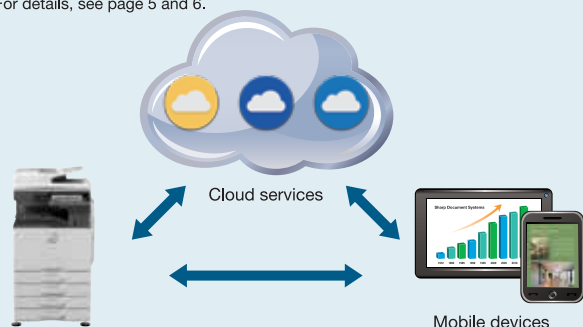

### Convert Documents via OCR

OCR capability on the MX-3560N/3060N lets you convert a scanned document into a searchable PDF file or into an editable Microsoft® Word, PowerPoint®, or Excel® file. This means you can do speedy text searches, even with large-volume documents, and you can easily copy and paste text data into other applications. Functions like these help you maximise work efficiency.

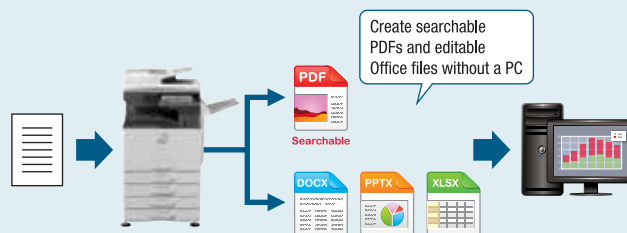

# Simply Better Experience

Office users

Sharp's proprietary technologies give each of these MFPs quick warm-up and first copy times. A motion sensor—a first for a Sharp MFP—lets you use the machine without feeling like you have to wait. Thanks to their intuitive operation and superb usability, the MX-3560N/3060N simplify even the most complex work processes and help you finish document jobs fast.



## Easy User Interface

The intuitive Easy UI mode makes it easy for anyone to use the MFP's advanced functions. In this mode, simple function icons are displayed on the 10.1-inch colour LCD touchscreen. Each user can customise the home screen by drag-and-dropping icons for commonly used functions, making for smoother, more efficient operation.



Customising the user interface (home screen)

## Motion Sensor

A built-in motion sensor detects your approach to the MFP and wakes it from Sleep mode. The control panel lights up and the machine finishes warming up as you enter your desired copy or scan settings. Then, with a minimum of waiting, you simply push the Start button to get the job underway.

Note: Detection range can be set to three different ranges.



# Simply Better Admin

IT managers / administrators

These MFPs fit securely and seamlessly into your office system. An advanced security environment and new, easily viewable administration tools reduce the workload for system administrators and give full support to their management duties.



## Secure Access Control

The MX-3560N/3060N support the **Active Directory®** service, which lets you use the machine's log-on credentials for internal network folders. System administrators can easily keep track of user credentials, which makes for an efficient and highly secure operational environment. And with **single sign-on**, you can access internal network folders by simply logging into the MFP—there's no need to re-enter your IDs and passwords.

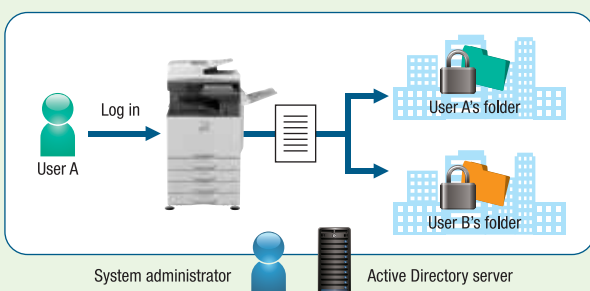

## Integrated Device Management

As a system administrator, you can get the most out of a Sharp document system by using Sharp's efficiency-boosting device management tools. From a single location, you can use Sharp Remote Device Manager (SRDM) to manage multiple Sharp MFPs. This includes everything from system setup, user access, and security settings to troubleshooting and maintenance. It's quick. It's effective. And it takes the hassle out of MFP management.

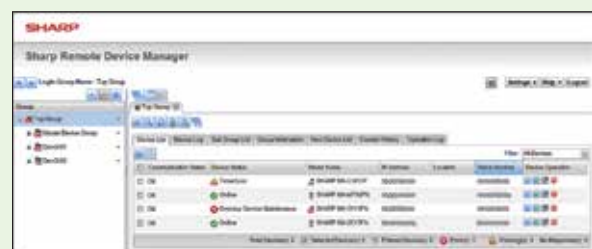

Sharp Remote Device Manager

# EASE OF USE

The smartly designed MX-3560N/3060N set the standard for usability. Ergonomic and intuitive features ensure everyone can enjoy stress-free operation of the MFP.

## 10.1-Inch Colour LCD Touchscreen

A user-friendly touchscreen interface incorporating a new Easy UI mode makes it easy and intuitive to operate the MFP. The Advanced Preview function, meanwhile, lets you check document finishes and page layout in advance, edit pages easily, and preview documents in various modes.



Preview mode (3D)



Edit mode (rotate)

## Easy Printing/Scanning with USB Drives

Insert a USB drive into the MFP and a print/scan command screen will automatically pop up on the LCD. Right away you can print files from the USB drive—which are displayed as thumbnails—or you can scan documents directly to the USB drive.



## New Printer Driver with Easy Setup

The printer driver setup window features an improved design that includes larger buttons and drop-down menus, making it easier than ever to use printer functions.

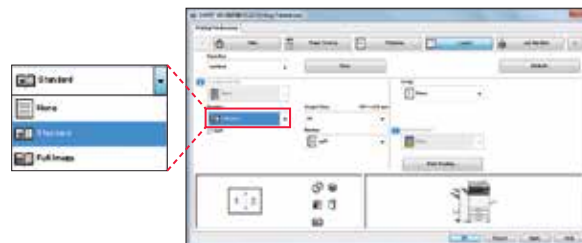

## LED Status Lamps

Next to the control panel are two LED lamps: one red, one green. These light up to notify you—even from a distance—of the status of the machine.

### 3 LED lamp modes

Job status mode

Machine status mode

Accessibility mode\*

\* Indicates whether documents have been properly set in the document feeder



## Universal Design

### Accessibility

These MFPs comply with the accessibility guidelines outlined in US Section 508 and EU Mandate 376. This means that all user aspects—from the heights of the control panel and glass platen to the readability of the LCD—have been designed with consideration for usability by people with disabilities.

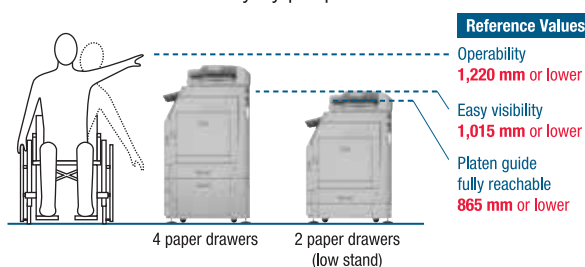

### Utility Table\*

An optional Utility Table gives you a handy place to lay documents or a mobile device such as a tablet when you're working at the MFP. An IC card reader can be built underneath the table.



\* Requires optional MX-UT10.

### Lock-on Handles

The paper drawers on these MFPs feature easy-grip, lock-on handles. As well as enabling easy opening and closing, they ensure that the paper drawers close properly, thereby enhancing safety in the event of a disaster such as an earthquake.

### Free-Tilting Control Panel

The control panel can be tilted freely at various angles for easy viewing and easy operation, even from a wheelchair. Having the control panel at the perfect viewing angle means you can reduce eye strain and avoid making input errors.



### Remote Operation\*

The Remote Operation function lets you display the MFP's main control panel on the screen of your PC or mobile device. From a remote location, you can then check MFP settings or reprint data stored on the MFP. This function also enables the administrator to guide an MFP user through necessary procedures and allows remote MFP operation from a wheelchair.

\* Requires VNC application. Simultaneous remote operation from two or more PCs or mobile devices is not possible. Remote operation also depends on the network environment and applications being used.

When it comes to image quality, the MX-3560N/3060N deliver a reliably excellent performance. Thanks to their outstanding precision and colour quality, these MFPs lend your documents a beautifully professional look.

## Easy, High-Quality Copying and Scanning

Through an advanced three-step process, **Auto Colour Mode** provides fully automated copying and scanning in both colour and B/W—with a simple press of the Start button. Here's how it works: **Auto Colour Selection** automatically determines whether a page is colour or B/W. **Auto Original Type Selection** then analyses page contents to distinguish between different components (such as photos and text) and selects the appropriate mode. Finally, **Background Suppression** automatically removes unnecessary background colour.

### Auto Colour Mode

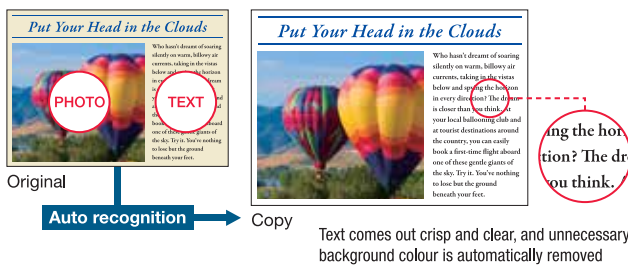

## Developer Refresh System

By discharging old developer little by little and continuously replacing it with new developer, this system prevents developer deterioration and ensures stable print quality over the long term.

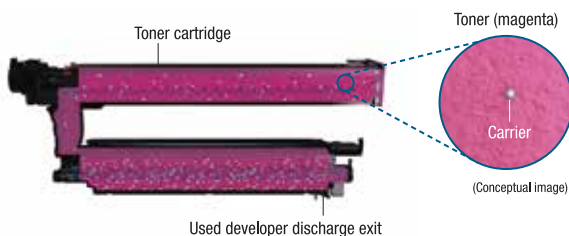

## PCL 6 and True Adobe® PostScript® 3™

For improved graphics handling and enhanced font compatibility, these MFPs come standard with both PCL 6 and true Adobe PostScript 3. In addition, the PostScript driver allows you to use the dot screening technique so that you can emulate the high-quality printing of commercial offset printers.

## High-Resolution Output

Each MFP's print engine supports 1,200 × 1,200 dpi printing and copying\*. Digital smoothing technology enhances the print and copy resolution to the equivalent of 9,600 × 600 dpi, giving you ultra-clear image quality. Fine lines and small text come out looking crisper and easier to read.

\* Copying in B/W only.

## Improved Colour Reproduction

By thoroughly revamping the imaging process, Sharp was able to expand the colour gamut for these MFPs. As a result, colour reproduction is more faithful and vivid compared to previous models.

### Colour Gamut Chart

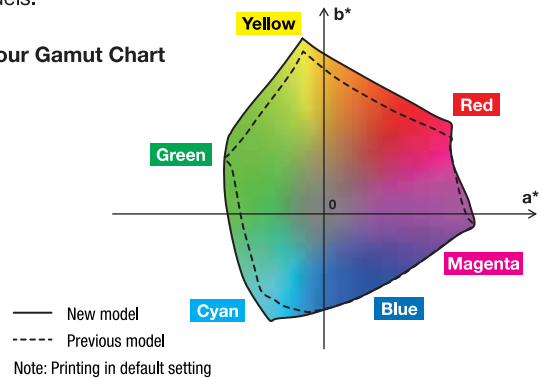

## Auto Process Control

To maintain consistently high image quality during large-volume print jobs, these MFPs employ an enhanced periodic colour calibration system. Image density sensors read high-density and halftone colour patches and feed the information back to the image control unit. The MFP can then make adjustments to minimise colour variance between pages.

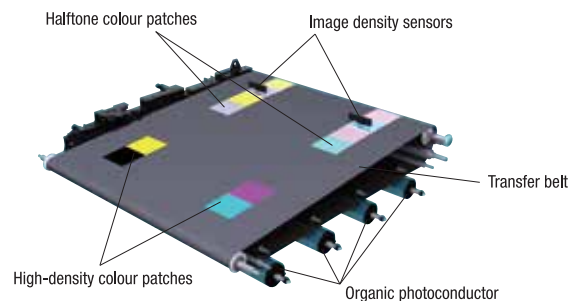

## Line Width Adjustment

This function adjusts the width of lines. Fine lines, which are otherwise difficult to render properly, turn out sharp and crisp. Intricate line drawings, complex graphs and charts, and detailed spreadsheets are reproduced with exceptional quality and precision.

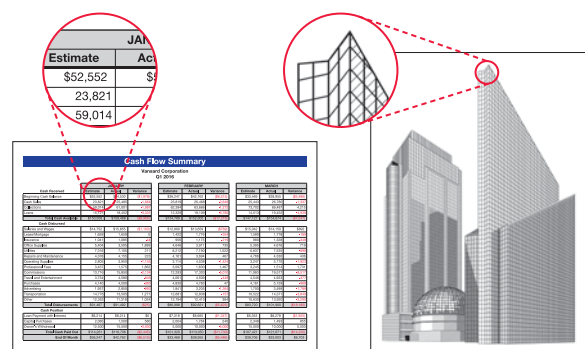

# SECURE INFORMATION SHARING

Whether you're in the office or out and about, being able to share information easily and securely is vital to the smooth running of your business. Secure information sharing with a Sharp MFP transforms your working style and helps you grab new opportunities before they pass.

## Link to Cloud Services\*

An MX-3560N/3060N doesn't just connect to your local server. It also connects with cloud services directly from the MFP's control panel. You can upload scanned data to Google Drive™, OneDrive® for Business, or SharePoint® Online—or print directly from any of them. Using a cloud service like this can save you the time and cost of setting up and managing a server within your company. Once you log into the MFP, you can quickly access multiple software services without having to sign in to each one separately. It's a true time-saver that gets your document jobs finished faster.

\* Requires optional MX-AMX2.

## Link with Mail Servers

Scanned data can be conveniently sent via your regular Gmail™ or Microsoft Exchange account. Sending e-mail is as easy as choosing a recipient from your address book on the mail server. Scanned data that you send can be stored on the mail server with other sent items.

## Sharp OSA\* (Open Systems Architecture)

Innovative Sharp OSA technology allows you to interact with critical business and network applications right from the LCD control panel, offering a new realm of control and convenience. And since Sharp OSA utilises industry-standard network protocols, the MX-3560N/3060N can easily integrate with document management systems, enterprise resource planning software, workflow applications, and more. The latest version of Sharp OSA can **reach beyond the firewall**, enabling extensive system construction as well as services delivered over the Internet such as cloud services.

In this way, Sharp OSA provides a foundation for cost reductions and information sharing across the entire company organisation—effectively enhancing total business efficiency.

\* Requires optional MX-AMX2 and/or MX-AMX3.

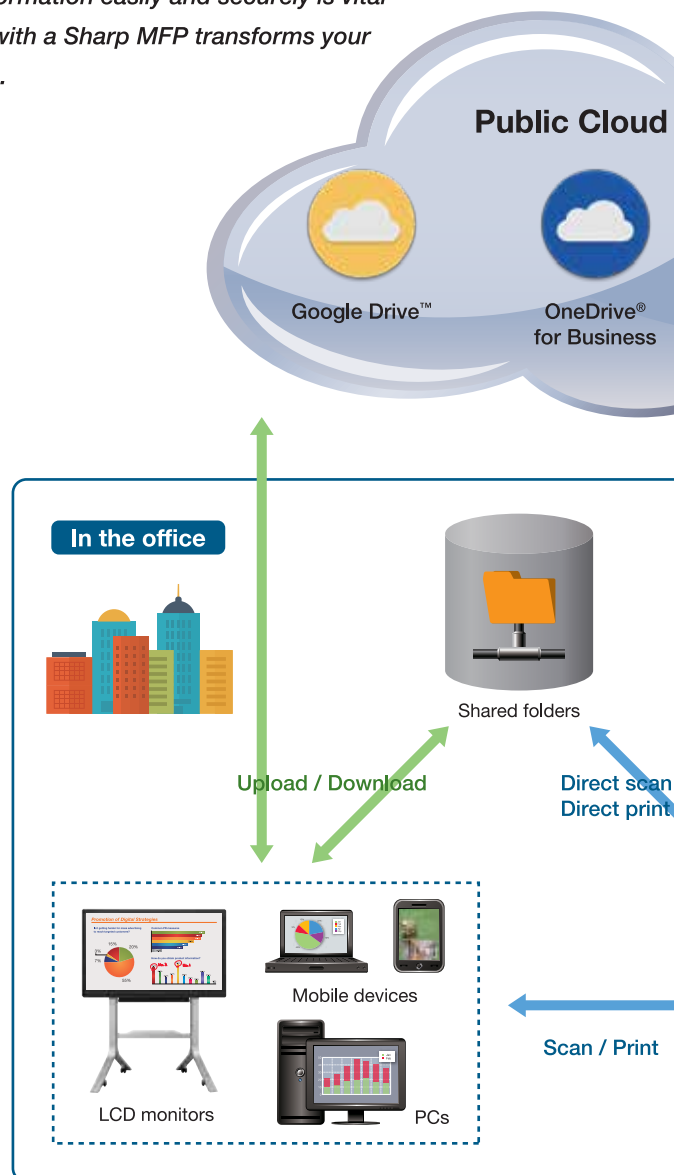

## Multi-Layered Security

Sharp's powerful data security solutions protect your business assets and give you peace of mind. These MFPs safeguard your sensitive data by employing multiple levels of security functions covering a broad range of network and data security needs.

### Network Security and Access Control

- **S/MIME** provides secure e-mail communications\*  
\* When sending e-mail only.
- **SSL** (secure sockets layer) and **IPsec** data encryption technologies ensure secure network communications
- **User Authentication** covering up to 1,000 users prevents unauthorised MFP use by requiring access passwords
- **Active Directory** enables integrated management of user credentials, thereby providing a highly secure and efficient environment for system administrators

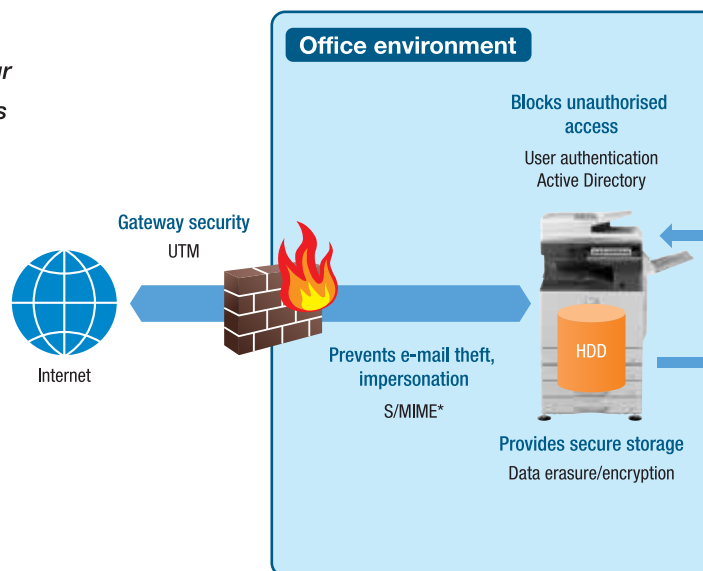

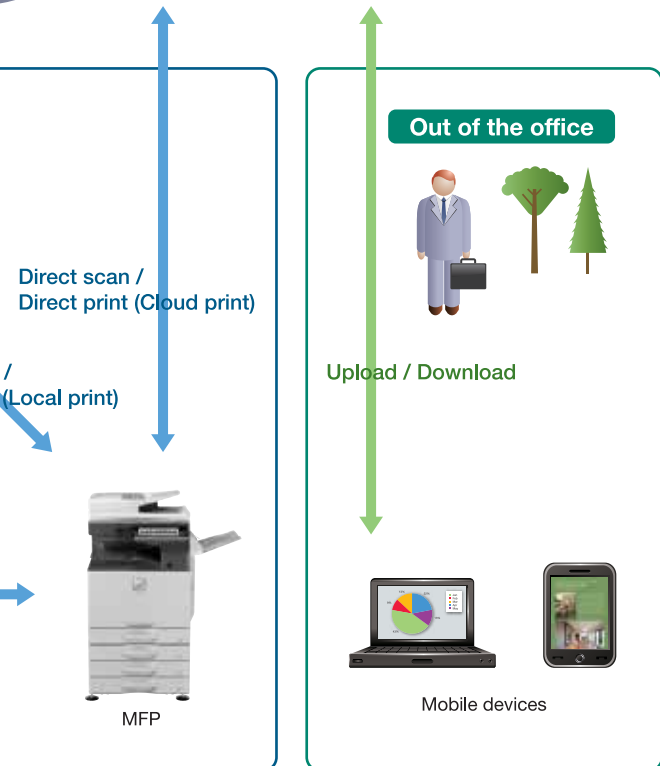
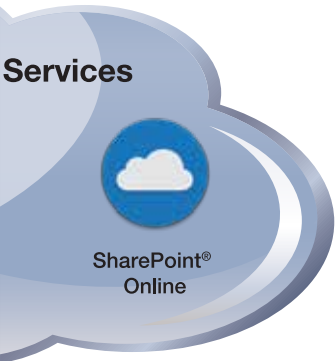

## Two-Way Sharing with Mobile Devices

Connecting an MX-3560N/3060N to one or more mobile devices is easy, and it expands your options for sharing data. Not only can you send scanned documents to mobile devices such as smartphones and tablets, you can also print documents or photos sent from those devices.

### Sharpdesk Mobile\*

Sharpdesk Mobile is a mobile print/scan application that connects the MFP to mobile devices via wireless LAN.

\* For details, see the Sharpdesk Mobile support Web site: [http://sharp-world.com/products/copier/docu\\_solutions/mobile/sharpdesk\\_mobile/](http://sharp-world.com/products/copier/docu_solutions/mobile/sharpdesk_mobile/)

### Mobile Printing Services

These MFPs support Google Cloud Print™, AirPrint, Mopria™, and Sharp Print Service Plugin.

## Wireless Connections

These MFPs offer ultra-handry wireless access via two easy modes, enabling convenient access to the MFP even from places where a wired LAN is not available.

**Infrastructure mode** wirelessly connects the MFP to mobile PCs/devices via a commercially available wireless LAN router.



**Access point mode** wirelessly connects a LAN-wired MFP to mobile PCs/devices without going through a wireless LAN router.



Note: External networks cannot be accessed via the MFP. Up to five mobile devices can be wirelessly connected to the MFP at the same time.

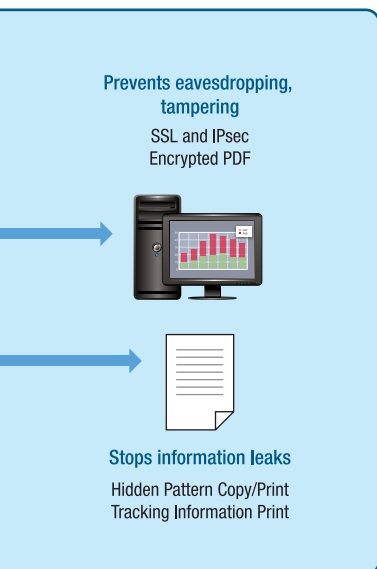

## Document Protection

- **Document Control\*** prevents unauthorised use of confidential documents by embedding copy prevention data in them

\* Requires optional MX-FR52U. May not work with certain types of paper, documents (such as those with a large volume of photos), or MFP settings.

- **Hidden Pattern Copy/Print** embeds a watermark, such as “Confidential” or “Not for Copy,” onto a document
- **Tracking Information Print** prints the MFP user’s name, the date, job ID, and other specifics on printouts, making it possible to track documents

## Data Protection

- Job data is automatically **encrypted** before being saved to the MFP’s internal storage. Once a job is finished, its encrypted data is **erased** by up to 10 automatic overwrites
- Retained data can be **initialised** when it’s time to replace the MFP, preventing the leakage of confidential information

Whether a document job is big or small, you want to get it done quickly and efficiently. The superb performance of these MFPs promises you a smooth workflow and high productivity.

## COPY/PRINT

### Super-Efficient Colour and B/W Output

The MX-3560N/3060N deliver a fast output of 35/30 ppm\* in B/W and in full colour. The first copy comes out in just 4.7 seconds in B/W and 6.7 seconds in full colour, saving you valuable time when performing multiple short-run jobs.



\* A4 long-edge feeding

### Print Release

The Print Release function lets you send documents to the main MFP, which acts as a server and stores them for printing out from any other MFP on the network. This function comes in handy when the main MFP is in use or under maintenance, letting you finish your job with minimal waiting.

### Versatile Paper Handling

Most of the MX-3560N/3060N's paper trays accommodate a wide variety of paper, in sizes up to SRA3 and in weights up to 300 g/m<sup>2</sup>. These MFPs can also handle extra-long paper up to 1.20 m\*. In addition to plain paper, the MFPs accommodate a number of other paper types, including coated, textured, embossed, and removable adhesive paper. Such versatile paper handling expands the range of possible printing applications.

\* Requires optional MX-LT10.

### Microsoft® Office Direct Printing\*

Print common Microsoft® Office files without using a PC. With a MX-3560N/3060N, you can print a Word, Excel®, or PowerPoint® file directly from a mobile device, cloud service, USB drive, or file server.

\* This function is enabled via DirectOffice™ technology.

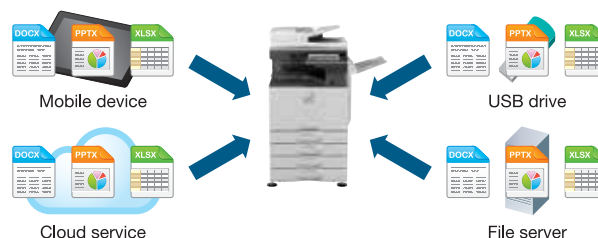

### Job Separator Tray\*

The helpful Job Separator Tray option prevents copy/print/fax jobs from getting mixed together in the main tray by letting you send one of the job types to the Job Separator Tray.



\* Requires optional MX-TR20.

\*\*A4 80 g/m<sup>2</sup>

## Finisher Options

These MFPs offer plenty of finishing options to suit a variety of workplaces and applications.

	MX-FN27 Finisher	MX-FN28 Finisher	MX-FN29 Saddle Stitch Finisher	MX-FN30 Finisher	MX-FN31 Saddle Stitch Finisher
Max. paper capacity*1	500 sheets	1,000 sheets	1,000 sheets	3,000 sheets	3,000 sheets
Stapleless stapling	Yes	–	–	Yes	Yes
Manual stapling	Yes	–	–	Yes	Yes
Saddle stitching	–	–	Yes	–	Yes
Punching*2	Yes	Yes	Yes	Yes	Yes

\*1: A4 80 g/m<sup>2</sup>

\*2: Requires optional punch module

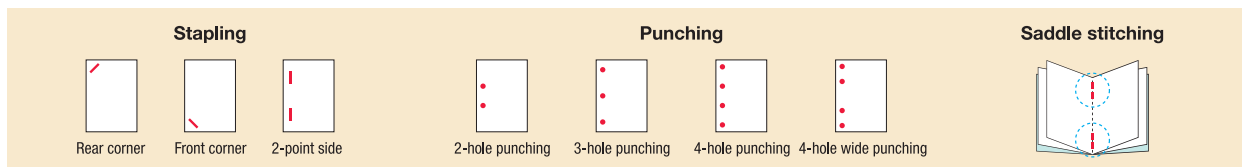

### Stapleless Stapler

To make paper recycling easy and to save on stapler costs, a staple-free stapler crimps the corners of paper to keep up to five sheets securely bound.



### Manual Stapler

You can quickly staple documents at the MFP as needed without using a conventional stapler. A real time-saver if you want to, say, restaple documents that were unstapled for copying.





# IMAGE SEND

## High-Efficiency Scanning

The MX-3560N/3060N's standard-equipped 100-sheet RSPF (reversing single pass feeder) efficiently feeds in either one- or two-sided originals. With a scanning speed of up to 80 opm\* (one-sided) for both colour and B/W documents, the MX-3560N/3060N can complete large jobs with ease and efficiency.

\* Originals per minute; when feeding A4 sheets



## Multiple Distribution of Scanned Files

Scanned documents can be distributed in a number of ways: for example, you can send them as e-mail attachments or scan them directly to an FTP server for storage. The standard-equipped compact PDF function lets you smoothly transmit and receive data.

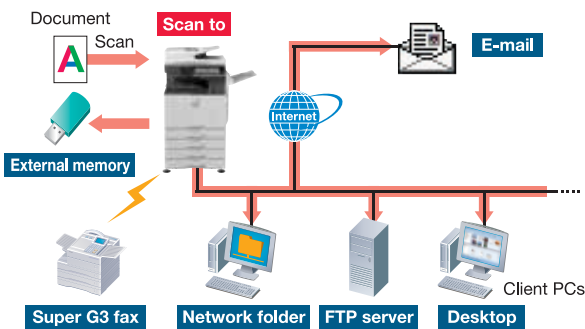

## Improved Address Book

The address book has an improved layout that includes new Frequent Use buttons, a separate Address list, and larger buttons, scroll bar, and text. This user-friendly design makes selecting the right scan/fax destinations more effortless than ever.



## Enhanced Scan Functions

### Automated Scanning\*

Using advanced optical character recognition, these MFPs can correct the vertical orientation of pages mixed in upside down. This conveniently saves you the hassle of having to rescan those pages. The MFPs can also automatically determine scan resolution and skip blank pages in a multi-page document.

\* Easy UI mode only

### Multi Crop Function

The Multi Crop function automatically creates separate files for multiple different-sized documents—such as receipts and bills—that are scanned simultaneously.

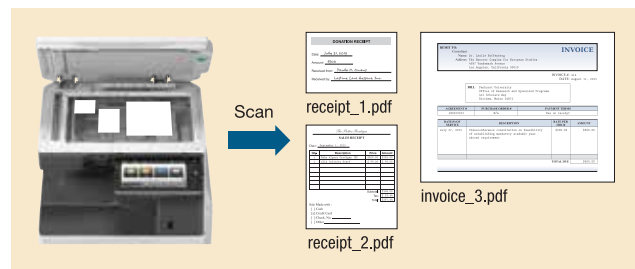

### Business Card Management

It's easy to manage a database of business cards with the MX-3560N/3060N. The MFP reads contact details on each card via OCR and then exports those details to a third-party contact management system of your choice.

### Versatile Fax Functions\*

- **Super G3 Fax** function
- **PC-Fax** lets you send documents created on a PC directly to a recipient's fax machine via a phone line without printing to paper

\* Requires optional MX-FX15.

## Document Management

### Document Filing

Document Filing allows processed data to be saved in designated folders on the MFP's hard disk. From there, it can be instantly recalled for printing and sending at a later time.

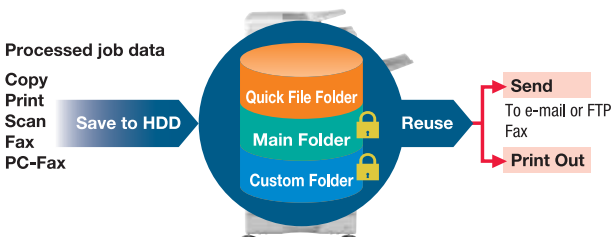

### Sharpdesk

With Sharpdesk integrated document management software, scanned files can be organised, edited, converted, and combined with ease. What's more, Full Text Search makes it easy to retrieve your documents.

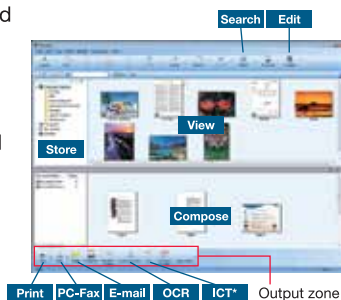

\* Image Compression Tool for converting images into compact PDF files

# ENVIRONMENT-FRIENDLY

With a view to minimising the environmental impact of its products, Sharp has applied its advanced technologies across all areas of these MFPs, including the hardware, firmware, electrical systems, and supplies.

## Low TEC Value\*1

In every respect, these MFPs have been designed to deliver exceptional energy efficiency. As a result, they boast a TEC value that is significantly lower than the maximum allowable values determined by ENERGY STAR®.

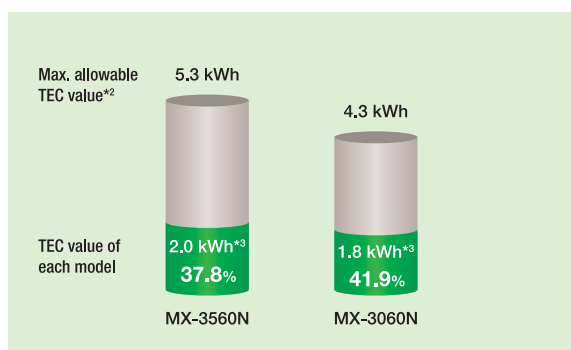

\*1: Typical amount of energy consumed in a hypothetical week measured as stipulated under the ENERGY STAR programme.

\*2: Maximum TEC value allowable under the latest ENERGY STAR programme (version 2.0).

\*3: Measured at 230 V.

## Quick-Heating Belt Fusing System

A newly developed quick-heating belt fusing system enables a short warm-up time of 10 seconds to reduce overall energy consumption.

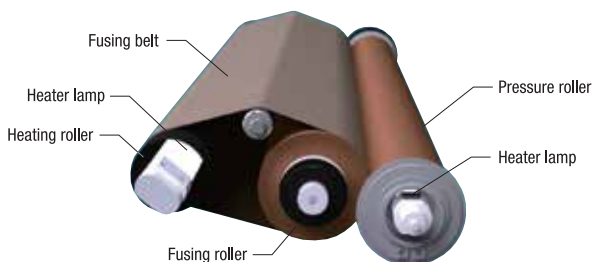

## Eco Recommendation

This function suggests environmentally friendly settings before a print\*/copy command is executed from the control panel.

\* For printing Document Filing data and direct printing (FTP/SMB/USB)



## Eco Scan

The Eco Scan function saves energy by keeping the fusing system shut down during jobs that don't require its use—for example, during image sending and Document Filing.

## Auto Power Shut-Off Mode

Based on prior usage patterns, the MFP automatically determines how long to wait before going into auto power shut-off mode. Shortly before this mode begins, a message appears on the LCD indicating that the MFP will soon shut down and giving you the option to continue operation.

## Power ON/OFF Schedule

This function automatically turns the MFP on or off per administrator-set schedules.

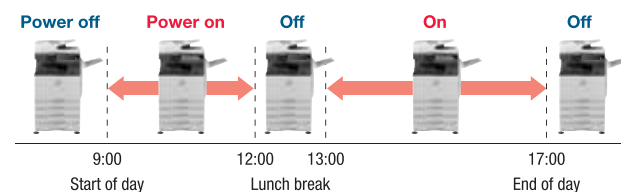

## Eco-Friendly Toner

New Mycrostoner-Crystal is filled with low-melting-point material. Compared to a conventional toner, this toner is able to fuse at lower temperatures, resulting in reduced energy consumption.

## Automatic Toner Cartridge Eject Function

This function expels completely empty cartridges in preparation for replacement. The cartridge is replaced only after all the toner has been consumed, thereby ensuring efficient use of toner. Because you can tell at a glance when cartridges are empty, they are fast and easy to replace.



# SYSTEM CONFIGURATION

## System Configuration

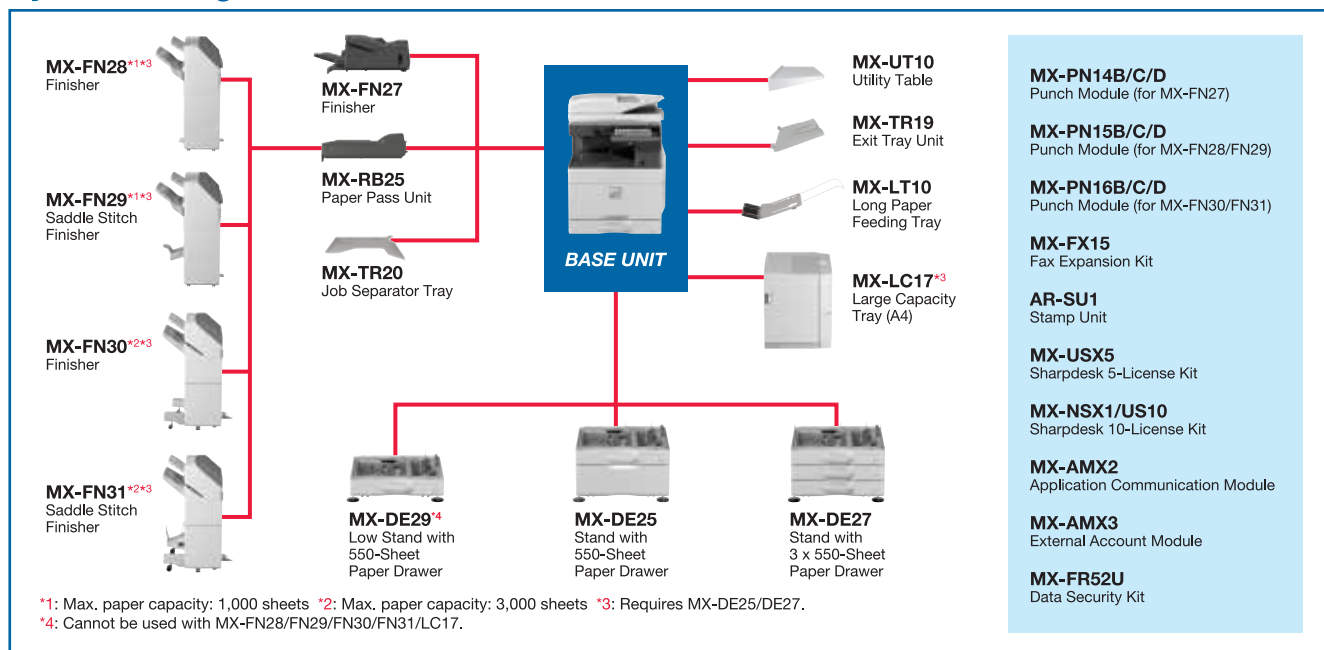

## Specifications for Options

### MX-FN27 Finisher

Paper size	Non offset Offset/staple Stapleless staple	SRA3 to A5 <sup>*1</sup> A3 to B5 <sup>*2</sup> A3 to B5 <sup>*3</sup>
Paper capacity	Non offset/offset Staple	500 sheets (A4 or smaller), 250 sheets (B4 or larger) 30 sets or 500 sheets (A4 or smaller), 30 sets or 250 sheets (B4 or larger)
Stapling capacity	Stapleless staple Staple Stapleless staple	30 sets 50 sheets (A4, B5 <sup>*3</sup> ), 30 sheets (A3, B4) 5 sheets <sup>*4</sup>
Staple position	Manual staple Staple mode Stapleless staple mode Manual staple mode	Total paper thickness 4 mm or less (40 sheets) 3 locations (front, rear, or 2-point stapling) 1 location (rear) 1 location

### MX-FN28 Finisher

Paper size	Non offset Offset Staple	SRA3 to A5 <sup>*1</sup> A3W to A5 <sup>*1</sup> A3W to B5 <sup>*1</sup>
Paper capacity	Finisher tray (non offset/offset) (staple)	1,000 sheets (A4), 500 sheets (other sizes) 100 sets or 1,000 sheets (A4), 50 sets or 500 sheets (other sizes)
Stapling capacity	Top tray	250 sheets (A4 or smaller), 50 sheets (B4 or larger) 50 sheets (A4, B5), 30 sheets (A3, B4)
Staple position		3 locations (front, rear, or 2-point stapling)

### MX-FN29 Saddle Stitch Finisher

Paper size	Non offset Offset Staple	SRA3 to A5 <sup>*1</sup> A3W to A5 <sup>*1</sup> A3W to B5 <sup>*1</sup>
Paper capacity	Finisher tray (non offset/offset) (staple)	1,000 sheets (A4), 500 sheets (other sizes) 100 sets or 1,000 sheets (A4), 50 sets or 500 sheets (other sizes)
Stapling capacity	Top tray Saddle stitch tray	250 sheets (A4 or smaller), 50 sheets (B4 or larger) 7 sets of 11–15 sheets, 10 sets of 6–10 sheets, 20 sets of 1–5 sheets
Staple position		50 sheets (A4, B5), 30 sheets (A3, B4) 3 locations (front, rear or 2-point stapling)

### MX-FN30 Finisher

Paper size	Non offset Offset/staple Stapleless staple	SRA3 to A5 <sup>*1</sup> A3 to B5 <sup>*2</sup> A3, A4 <sup>*2</sup>
Paper capacity	Finisher tray (non offset/offset) (staple)	3,000 sheets (A4, B5), 1,500 sheets (other sizes) 200 sets or 3,000 sheets (A4, B5), 100 sets or 1,500 sheets (other sizes)
Stapling capacity	Top tray Staple Stapleless staple Manual staple	250 sheets (A4 <sup>*2</sup> , B5 <sup>*2</sup> , A5), 125 sheets (other sizes) 65 sheets (A4 <sup>*2</sup> , B5 <sup>*2</sup> ), 30 sheets (other sizes) 5 sheets <sup>*4</sup> Total paper thickness 9 mm or less (65 sheets)
Staple position	Staple mode Stapleless staple mode Manual staple mode	3 locations (front, rear, or 2-point stapling) 1 location (rear) 1 location

### MX-FN31 Saddle Stitch Finisher

Paper size	Non offset Offset/staple Stapleless staple	SRA3 to A5 <sup>*1</sup> A3 to B5 <sup>*2</sup> A3, A4 <sup>*2</sup>
Paper capacity	Finisher tray (non offset/offset) (staple)	3,000 sheets (A4, B5), 1,500 sheets (other sizes) 200 sets or 3,000 sheets (A4, B5), 100 sets or 1,500 sheets (other sizes)
Stapling capacity	Top tray Saddle stitch tray	200 sets (A4), 100 sets (A3) 250 sheets (A4 <sup>*2</sup> , B5 <sup>*2</sup> , A5), 125 sheets (other sizes) 10 sets of 11–20 sheets, 15 sets of 6–10 sheets, 25 sets of 1–5 sheets
Staple position	Staple Stapleless staple Manual staple	65 sheets (A4 <sup>*2</sup> , B5 <sup>*2</sup> ), 30 sheets (other sizes) 5 sheets <sup>*4</sup> Total paper thickness 9 mm or less (65 sheets)
Staple position	Staple mode Stapleless staple mode Manual staple mode	3 locations (front, rear, or 2-point stapling) 1 location (rear) 1 location

### Punch Modules

Model name	For MX-FN27	<b>MX-PN14B</b>	<b>MX-PN14C</b>	<b>MX-PN14D</b>
	For MX-FN28/FN29	<b>MX-PN15B</b>	<b>MX-PN15C</b>	<b>MX-PN15D</b>
	For MX-FN30/FN31	<b>MX-PN16B</b>	<b>MX-PN16C</b>	<b>MX-PN16D</b>
Number of holes	2 or 3		2 or 4	4 (wide)
Paper weight	55 to 300 g/m <sup>2</sup> <sup>*5</sup>			

### MX-TR20 Job Separator Tray

Paper size	SRA3 to A5 <sup>*1</sup>
Paper capacity	100 sheets (A4)

### MX-DE25 Stand with 550-Sheet Paper Drawer

Paper size	SRA3 to A5 <sup>*1</sup>
Paper capacity	550 sheets

### MX-DE27 Stand with 3 x 550-Sheet Paper Drawer

Paper size	SRA3 to A5 <sup>*1</sup>
Paper capacity	550 sheets each

### MX-DE29 Low Stand with 550-Sheet Paper Drawer

Paper size	SRA3 to A5 <sup>*1</sup>
Paper capacity	550 sheets

### MX-LC17 Large Capacity Tray

Paper size	A4, B5
Paper capacity	3,000 sheets

### MX-LT10 Long Paper Feeding Tray

Paper size	Max. 1.20 m long
Paper capacity	1 sheet

<sup>\*1</sup>: Short-edge feeding. <sup>\*2</sup>: Long-edge feeding. <sup>\*3</sup>: Only long-edge feeding can be used with A4 and B5 paper. <sup>\*4</sup>: Guaranteed stapleable weight is up to 64 g/m<sup>2</sup> (4 sheets up to 81.4 g/m<sup>2</sup> and 3 sheets up to 105 g/m<sup>2</sup>). <sup>\*5</sup>: Guaranteed punchable weight is 60 to 128 g/m<sup>2</sup>.

Note: All specifications relating to paper capacity refer to 80 g/m<sup>2</sup> paper.

## SPECIFICATIONS

### General

Type	Desktop	
Engine speed	A4*1: Max. 35/30 ppm	
	A3: Max. 18/16 ppm	
	SRA3: Max. 16/15 ppm	
Control panel display	10.1-inch colour LCD touchscreen	
Paper size	Max. SRA3, min. A5*2	
Paper capacity (80 g/m <sup>2</sup> )	Standard: 650 sheets (550-sheet tray and 100-sheet multi-bypass tray) Maximum: 5,300 sheets (650 sheets & optional 3 x 550-sheet tray and 3,000-sheet tray)	
Paper weight	Tray: 60 g/m <sup>2</sup> to 300 g/m <sup>2</sup> Multi-bypass tray: 55 g/m <sup>2</sup> to 300 g/m <sup>2</sup>	
Warm-up time*3	10 sec.	
Memory	5GB (copy/print shared)	500GB HDD*4
Power requirements	Rated local AC voltage ±10%, 50/60 Hz	
Power consumption	Max. 1.84 kW (220 to 240V)	
Dimensions (W x D x H)*5	608 x 650 x 834 mm	
Weight (approx.)	79 kg	

### Copier

Original paper size	Max. A3	
First copy time*6	Full colour: 6.7 sec.	B/W: 4.7 sec.
Continuous copy	Max. 9,999 copies	
Resolution	Scan (colour): 600 x 600 dpi Scan (B/W): 600 x 600 dpi, 600 x 400 dpi, 600 x 300 dpi Print (colour): 600 x 600 dpi, 9,600 (equivalent) x 600 dpi (depending on copy mode) Print (B/W): 1,200 x 1,200 dpi, 600 x 600 dpi, 9,600 (equivalent) x 600 dpi (depending on copy mode) Equivalent to 256 levels	
Gradation	Equivalent to 256 levels	
Zoom range	25 to 400% (25 to 200% using RSPF) in 1% increments	
Pre-set copy ratios	Metric: 10 ratios (5R/5E), inch: 8 ratios (4R/4E)	

### Network Scanner

Scan method	Push scan (via control panel) Pull scan (TWAIN-compliant application)
Scan speed*7	[Colour & B/W] Max. 80 originals/min.
Resolution	Push scan: 100, 150, 200, 300, 400, 600 dpi Pull scan: 75, 100, 150, 200, 300, 400, 600 dpi 50 to 9,600 dpi via user setting
File formats	TIFF, PDF, PDF/A, encrypted PDF, compact PDF*8, JPEG*8, XPS, searchable PDF, Microsoft® Office (ppbx, xlsx, docx), text (TXT), rich text (RTF)
Scanner utility	Sharpdesk
Scan destinations	Scan to e-mail/desktop/FTP server/network folder (SMB)/USB drive/HDD

- \*1: Long-edge feeding.
- \*2: Short-edge feeding.
- \*3: At rated voltage, 23°C (73.4°F). May vary depending on operating conditions and environment.
- \*4: HDD capacity depends on procurement and sourcing status.
- \*5: Including adjusters and protuberances.
- \*6: Long-edge feeding of A4 sheets from 1st paper tray, using document glass, without Auto Colour Selection and Auto Colour mode, MFP in fully ready condition. May vary depending on operating conditions and environment.
- \*7: Based on Sharp's A4 standard chart, using document feeder, long-edge feeding, and one-sided scanning. Using factory default settings with Auto Colour Selection off. Scan speed will vary depending on the type of document and the scan settings.
- \*8: Colour/greyscale only.
- \*9: Storage capacity will vary depending on the type of document and the scan settings.
- \*10: Some features require option(s).
- \*11: Based on Sharp's standard chart with approx. 700 characters (A4 long-edge feeding) at standard resolution in Super G3 mode, 33,600 bps, JBIG compression.

### Document Filing

Document filing capacity*9	Main and custom folders: 20,000 pages or 3,000 files Quick file folder: 10,000 pages or 1,000 files
Stored jobs*10	Copy, print, scan, fax
Storage folders	Quick file folder, main folder, custom folder (max. 1,000 folders)

### Network Printer

Resolution	1,200 x 1,200 dpi, 600 x 600 dpi, 9,600 (equivalent) x 600 dpi
Interface	USB 2.0, 10Base-T/100Base-TX/1000Base-T
Supported OS	Windows Server® 2008, Windows Server® 2008 R2, Windows Server® 2012, Windows Server® 2012 R2, Windows Vista®, Windows® 7, Windows® 8.1, Windows® 10 Mac OS X 10.4, 10.5, 10.6, 10.7, 10.8, 10.9, 10.10, 10.11 TCP/IP
Network protocols	TCP/IP
Printing protocols	LPR, Raw TCP (port 9100), POP3 (e-mail printing), HTTP, FTP for downloading print files, IPP, SMB, WSD
PDL	PCL 6 emulation, Adobe® PostScript® 3™
Available fonts	80 fonts for PCL, 139 fonts for Adobe PostScript 3

### B/W Facsimile (optional MX-FX15 required)

Compression method	MH/MR/MMR/JBIG
Communication protocol	Super G3/G3
Transmission time	Less than 3 seconds*11
Modem speed	33,600 bps to 2,400 bps with automatic fallback
Transmission resolution	From Standard (203.2 x 97.8 dpi) to Ultra Fine (406.4 x 391 dpi)
Recording size	A3 to A5
Memory	1GB (built-in)
Greyscale levels	Equivalent to 256 levels

- Design and specifications are subject to change without prior notice.
- The ENERGY STAR logo is a certification mark and may only be used to certify products that have been determined to meet the ENERGY STAR programme requirements. ENERGY STAR and the ENERGY STAR mark are registered trademarks owned by the US Environmental Protection Agency. The ENERGY STAR guidelines apply to products only in the US, the EU, Japan, Canada, Australia, New Zealand, and Taiwan.
- Microsoft, Windows, Windows Server, Windows Vista, PowerPoint, Excel, Active Directory, SharePoint, and OneDrive are either registered trademarks or trademarks of Microsoft Corporation in the US and/or other countries. Mac OS is a trademark of Apple Inc., registered in the US and other countries. Adobe and PostScript 3 are either registered trademarks or trademarks of Adobe Systems Incorporated in the US and/or other countries. PCL is a registered trademark of Hewlett-Packard Company. Android, Google Cloud Print, and Google Drive are trademarks of Google Inc. The Google Drive trademark is used with permission from Google Inc. DirectOffice is a product of CSR Imaging US, LP. DirectOffice is a trademark of CSR Imaging US, LP, registered in the US and other countries, used with permission. All other brand names and product names may be trademarks or registered trademarks of their respective owners.

DIRECTOffice™

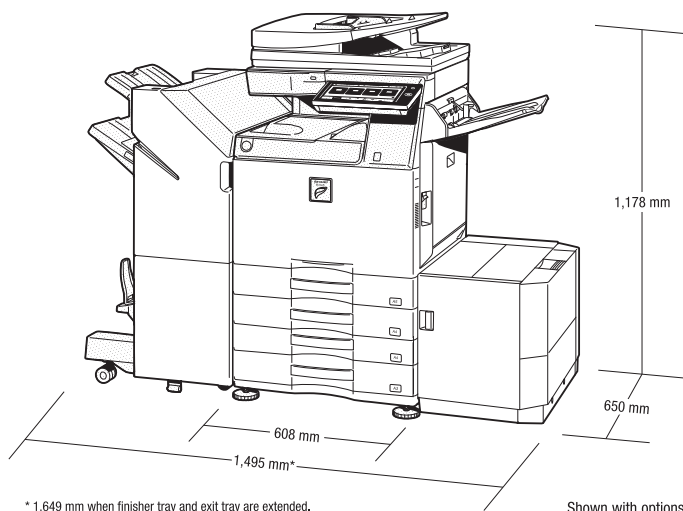

**SHARP**

BUSINESS | 文件系統



時捷電氣  
S.A.S. Electric

MX-3560N / 3060N CAT

S.A.S. ELECTRIC COMPANY LIMITED

Hotline : 2822 9395

<http://www.sharp.com.hk>