

SHARP

REFRIGERATOR-FREEZER
原裝進口雪櫃

MODEL 型號

SJ-BR13D

OPERATION MANUAL 使用說明書

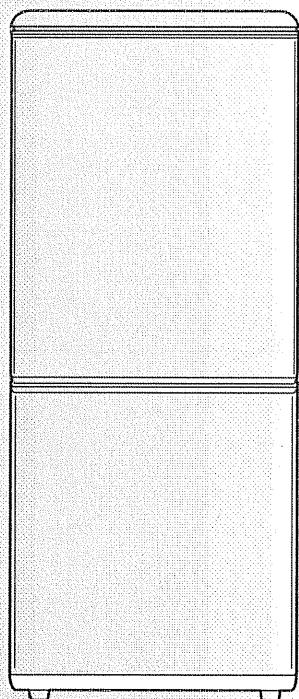

Thank you very much for buying this SHARP product. Before using your SHARP refrigerator, please read this operation manual to ensure that you gain the maximum benefit from your new refrigerator.

感謝您購買SHARP產品。在使用之前，為使您能夠充分使用您所購買的SHARP雪櫃，請仔細閱讀本使用說明書。

CONTENTS

● WARNING	2
● CAUTION	2
● PARTS NAME	3
● INSTALLATION	3
● HOW TO REVERSE REFRIGERATOR COMPARTMENT DOOR	4
● OPERATION	6
● STORING FOOD	7
● CARE AND MAINTENANCE	8
● BEFORE CALLING FOR SERVICE	8

目錄

● 警告	9
● 安全注意事項	9
● 各部分名稱	10
● 安裝	10
● 如何改變雪櫃門的開啟方向	11
● 使用方法	13
● 食物的儲存	14
● 保養和清潔	15
● 送修之前的初步檢查	15

香港電器安全規格
(國際電工委員會規格適合)



冷媒 異丁烷 Iso-butane R600a

此冰箱必須由受過訓練的技師在工場進行維修。
Maintenance work of the refrigerator must only
be carried out at workshop by well-trained
maintenance worker.

WARNING

1. This refrigerator contains flammable refrigerant (R600a: isobutane) and insulation blowing gas (cyclopentane). Observe the following rules to prevent ignition and explosion.
 - The refrigeration system behind and inside the refrigerator contains refrigerant. Do not allow any sharp objects to come into contact with the refrigeration system.
 - Do not use other electric appliances inside the refrigerator.
 - Children should be supervised to ensure that the refrigerator should be used properly.
 - Do not use mechanical devices or other means to accelerate the defrosting process. (This refrigerator has adopted automatic defrosting system.)
 - Do not block the openings on the circumstances of the refrigerator.
 - In case of having damaged the refrigerant circuit, do not use electric items or fire equipments nearby, and open all windows to provide good ventilation. Please contact service agent approved by SHARP for servicing.
 - The warning labels should be kept throughout the life of the refrigerator. The user manual should be handed over to any person who would use or handle the refrigerator whenever the refrigerator would be transferred to another location and delivered to a recycling plant.
 - Use only the specified lamp for the refrigerator compartment.
 - This refrigerator should be disposed appropriately. Take the refrigerator to a recycling plant for flammable refrigerant and insulation blowing gases.
2. This refrigerator is airtight. TO PREVENT FATAL ACCIDENTS TO CHILDREN, please completely remove the doors prior to discarding the refrigerator.
3. Highly volatile and inflammable materials such as ether, petrol, propane gas, adhesive agents and pure alcohol etc. are liable to explode. Do not store these materials in the refrigerator.
4. To prevent damage to the outer cabinet, avoid contact with lacquer, and paint, etc.
5. When cleaning your refrigerator, do not splash water directly on the outer cabinet or the interior. This may lead to rusting and deterioration of the electrical insulation.
6. When cleaning any areas adjacent to electrical components, unplug the refrigerator first to prevent electric shock.
7. Should electrical components be accidentally immersed in water, unplug the refrigerator, dry the parts and contact your nearest service agent approved by SHARP.
8. When disconnecting the power plug, do not touch the pin of plug. This may cause electric shock.
9. This refrigerator is designed solely for the purpose of storing foodstuff for domestic use in accordance with the instructions given in this manual. Using the refrigerator for other purposes might be harmful to persons or property.
10. This refrigerator is not suitable for the storage of materials requiring precise temperatures. Deterioration of these materials will be dangerous.
11. Dust deposited on the power plug may cause fire. Wipe it off carefully and occasionally.
12. Do not attempt to change or modify this refrigerator. This may result in fire, electric shock or injury.

CAUTION

1. Do not touch the compressor unit or its peripheral parts, as they become extremely hot during operation and the metal edges may cause injury.
2. If the power supply is accidentally disconnected, please wait for at least 6 minutes before re-connecting the power, as back pressure in the compressor may trip the overload relay.
3. Avoid removing food from the freezer with your bare hands. Directly touching products stored at sub-zero temperatures can result in frostbite.
4. To prevent accidental power disconnection, plug the refrigerator directly to the source. Do not use an extension cord as loss of power could lead to the spoiling of the stored food.
5. Do not place bottles in the freezer as they may crack when frozen.
6. Keep the door securely closed. If the door is left ajar, the controlled inner temperature will rise, resulting in food spoilage and increase in electricity costs.
7. Do not install the refrigerator in a damp or wet location as this may cause damage to the insulation and a leak. Condensation may also build on the outer cabinet and cause rust.
8. When installing or moving the refrigerator, make sure that you do not nip or kink the power cord. Damage of the power cord may cause electric shock or fire.
9. Do not use this refrigerator when the power cord or plug is damaged, or the outlet attachment is loose, as they may cause electric shock or fire.
10. Disconnect from the main electricity supply by removing the the electricity supply socket. Do not remove by pulling the power cord. This may cause electric shock or fire.
11. Make sure that you leave adequate ventilation space around the refrigerator to prevent the compressor from overheating and stopping. Please follow the instructions given for installation.
12. Should the power cord be damaged, it must be replaced by service agent approved by SHARP as a special cord is required.
13. In case of gas leak, ventilate the area by opening a window, etc. Do not touch the refrigerator or the power socket.
14. Do not place heavy or easily broken objects on top of the refrigerator. Objects may fall when opening or closing the refrigerator, causing injury.
15. Do not place objects containing liquid on top of the refrigerator. Spillage may cause electric shock or fire.
16. Do not drop objects inside the refrigerator or strike the inner wall. This may cause the inner surface to crack.
17. This refrigerator is not intended for use by persons (including children) with reduced physical, sensory or mental capabilities, or lack of experience and knowledge, unless they have been given supervision or instruction concerning use of the refrigerator by a person responsible for their safety.
18. Young children should be supervised to ensure that they do not play with the refrigerator.

PARTS NAME

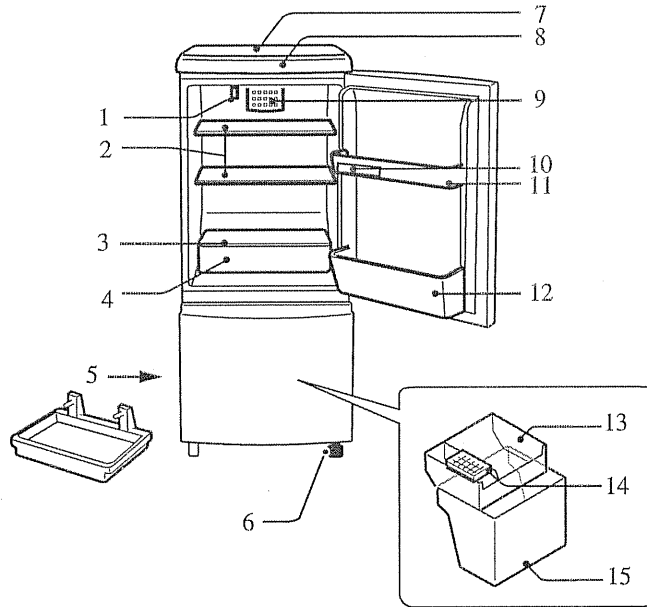

- 1. Freezer temp. control knob
- 2. Tempered glass shelves
- 3. Fresh shelf
- 4. Fresh case
- 5. Evaporating pan
- 6. Adjustable foot
- 7. Table top

- 8. Cover
- 9. Light
- 10. Egg case
- 11. Door pocket
- 12. Bottle pocket
- 13. Slide case
- 14. Ice cube tray
- 15. Freezer case

Do not place hot objects on Table top. The table may melt and deform. The table can resist temperatures up to 100°C.

INSTALLATION

1. To ensure adequate ventilation for your refrigerator, it is recommended to provide space of 6cm on both sides and at the back, and space of 30cm above the refrigerator. Insufficient spacing will decrease the cooling efficiency, resulting in unnecessary consumption of electricity.

2. Using the front Adjustable foot, ensure that the refrigerator is positioned firmly and level on the floor.

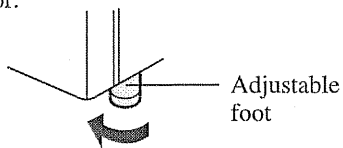

3. In order to prevent possible electric shock, install the grounding wire to the earth wire connecting screw at the rear of the refrigerator.

4. Set the Evaporating pan (supplied inside the refrigerator compartment) at the back of the refrigerator. (refer to the above description.)

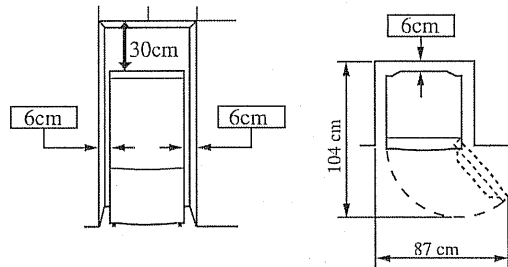

NOTE:

- Position your refrigerator so that the plug is accessible.
- Keep your refrigerator out of direct sunlight.
- Do not place next to heat generating appliance.
- Do not place directly on the ground. Provide suitable stand.

Before using your refrigerator

Clean the inside parts with a cloth soaked in warm water. If soapy water is used, wipe it off thoroughly.

HOW TO REVERSE REFRIGERATOR COMPARTMENT DOOR

The refrigerator compartment door can be changed to a left-opening door.
Prepare a slotted screwdriver.

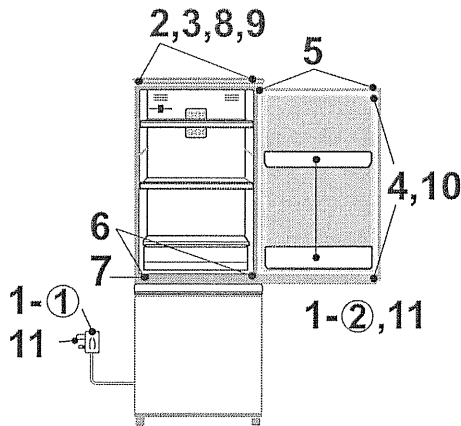

NOTE:

- To reverse the door, follow the instructions at right and make sure that each part is reversed correctly. Otherwise the door could fall off the refrigerator during use.
- Take care that the door does not fall off while reversing it. The falling door could cause injuries.
- Keep removed parts out of reach of infants to prevent ingestion.
- Do not wipe off the grease (oil) applied to the shafts and door.

1 Preparation

- (1) Disconnect the power plug from the wall socket.
- (2) Remove all door pockets.

2 With the refrigerator compartment door close, remove the cover.

- (1) While lifting the cover, push in the symbols (2 places) above the table cover, and release the claws.

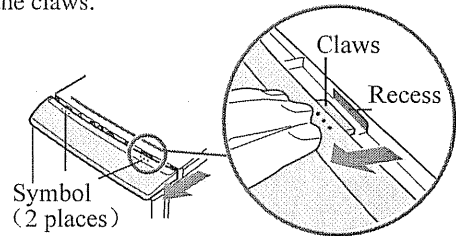

- (2) While pressing down the rear of the cover, lift it up in the front.

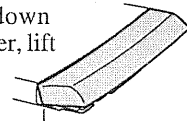

3 Close the refrigerator compartment door, and pull out the right shaft (upper) with a slotted screwdriver.

(If this work is carried out with the door open, the door could fall off)

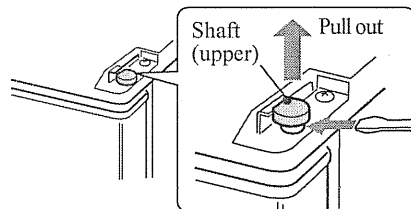

4 Hold the refrigerator compartment door with both hands, and place it on the floor.

- Holding the door at the top, pull it slightly forward and lift it off.
- Place the door on the floor, making sure it does not fall over and get damaged or scratch the floor.

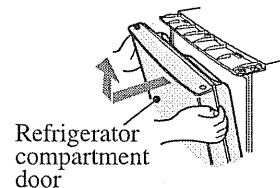

5 Reverse the bearing and hole cover of the door.

- Remove the hole cover by inserting a slotted screwdriver into the recess shown in the drawing, and pushing it down.

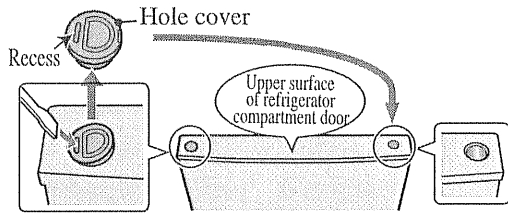

- Make sure to attach the hole cover firmly. Otherwise it may fall off and get lost.

6 Remove the shaft (lower) from the right bearing, and insert it into the left bearing.

The shaft (lower) may sometimes adhere to the bottom of the removed door.

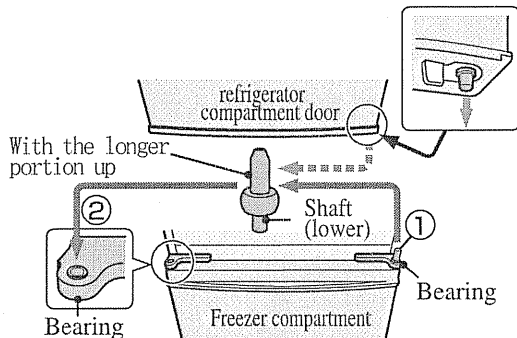

7 Engaging the hole at the lower left of the refrigerator compartment door with the shaft (lower).

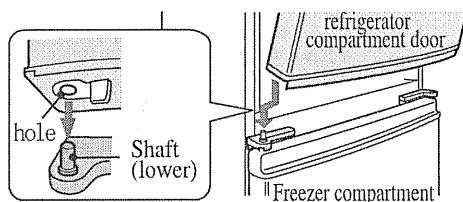

- Hold the refrigerator compartment door firmly to make sure it does not fall down.
- Take care not to get your fingers caught between the refrigerator compartment door and the shaft (lower).

8 Close the refrigerator compartment door, align the holes, and insert the shaft (upper).

- If the refrigerator compartment door is in a slanted position, you will not be able to insert the shaft (upper).

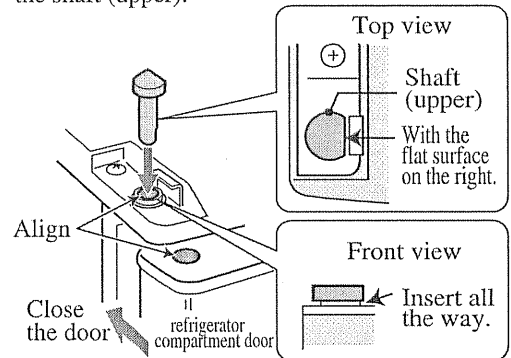

9 Attach the cover

- (1) Incline the cover and align its rear claws (6 places) with the holes (6 places) in the table top.
- (2) Engage the rear claws (6 places).
- (3) Press the cover from the top, and engage the front claws (3 places).

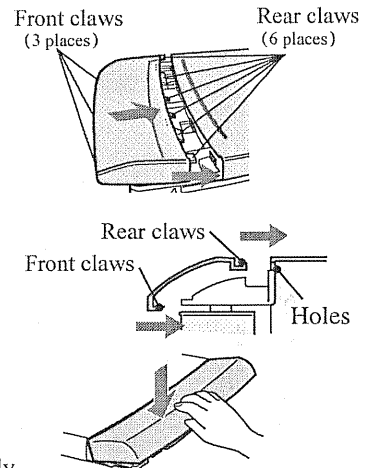

- Attach the cover firmly
- If the shaft (upper) is not properly inserted, the cover may become loose.

10 Check that the refrigerator compartment door opens and closes smoothly.

11 Attach the door pockets, and connect the power plug.

Use the same procedure to change from a left-opening to a right-opening door.

OPERATION

CONTROLLING TEMPERATURES

There is no temperature control in refrigerator compartment, temperature in refrigerator compartment will be controlled automatically.

Please follow steps below to adjust temperature, if necessary.

Freezer compartment
FREEZER TEMP
CONTROL KNOB

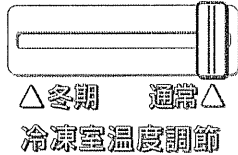

Freezer compartment set point should be at [通常]. When temperature is stable, temperature at middle bottom in freezer compartment is about -18°C.

In winter, if environment temperature around refrigerator is lower than 10°C, please set temperature control at [冬期] position.

Note

- In summer, if temperature control is set at [冬期] position, refrigerator compartment could not get enough cold. In this case, please set temperature control at [通常] position.
- In winter, if temperature control is set at [通常] position, freezer compartment could not get cold, in this case, please set temperature control at [冬期] position.
- If users want to freeze the food faster, please set temperature control at [冬期] position.

HOW TO USE ACCESSORIES

Tempered glass shelf

Please follow instruction to install tempered glass shelf.

If installing with printing side up, it will scratch printing.

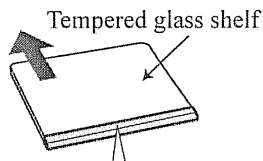

Please make sure tempered glass shelf trim should be toward user, otherwise it would scratch case liner.

Shelves

- Please put food at the rear of shelf.
(Otherwise, food will fall down when opening door.)
- Please don't stack food.
(Otherwise, food will fall down when opening door.)

Fresh case, Fresh shelf

Fresh case

Fresh case is suitable for storing fish and meat, because temperature inside of fresh case will be 1-2 degree cooler than refrigerator compartment.

Please don't put in food which contains water such as vegetable, because such food will get frozen.

Fresh shelf

"Front" means installation direction should be toward user.

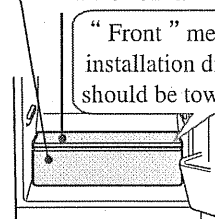

How to disassemble freezing case

- (1) Fully pull out door and put on the ground
- (2) Take out

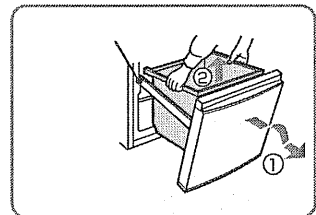

HINTS WHEN MAKING ICE

1. Do not overfill the ice cube tray; otherwise the ice cubes will be joined together when frozen.
2. When the ice cubes are made, hold the ice cube tray upside down whilst twisting either end in opposite directions, allowing the ice cubes to drop out.

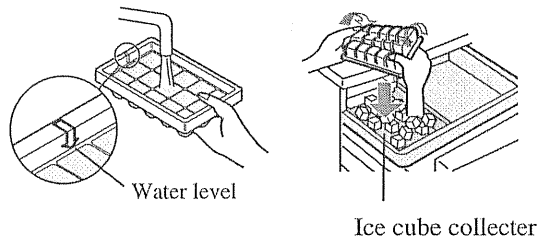

NOTE: To prevent damage to the slide case, do not make ice in the ice cube collector of the slide case or pour oil into it.

DEFROSTING

Defrosting is fully automatic due to a unique energy saving system. Whereby the defrost cycle start time is adversely proportional to the running time of your refrigerator compressor, i.e., the less time the refrigerator compressor operates (during the winter season or you are away on holidays), the longer the time between each defrost cycle.

DEODORIZING UNIT

A built-in unit which requires no manual operation because it automatically starts operating when the refrigerator is powered on.

STORING FOOD

Refrigeration reduces the rate of food spoilage. To maximize the service life of perishable food products, ensure that the food is of the freshest possible quality. The following is a general guide to help promote longer food storage.

Fruit / Vegetables

To minimize moisture loss, fruit and vegetables should be loosely enclosed in a plastic material e.g. wrap bags (do not seal). Those fruits and vegetables with thick skins, e.g. oranges, do not require wrapping.

Dairy Products

- Most dairy products have a expiry date on the outer packaging which informs the recommended temperature and service life of the product.

Meats / Fish / Poultry

- Place on a plate or dish and cover with paper or plastic wrap. Then, place in the Fresh case.
- For larger cuts of meat, fish, or poultry, place to the rear of the shelves.
- Ensure all cooked food is wrapped securely or placed in an airtight container.

NOTE:

- Evenly place the food on the shelves to allow the cool air to circulate efficiently.
- Hot foods should be cooled before storing. Storing hot foods increases the temperature inside the unit and increases the risk of food spoilage.
- Do not block the outlet and inlet of the cool air circulating circuit with foods or containers; otherwise the foods will not be evenly cooled throughout the refrigerator.

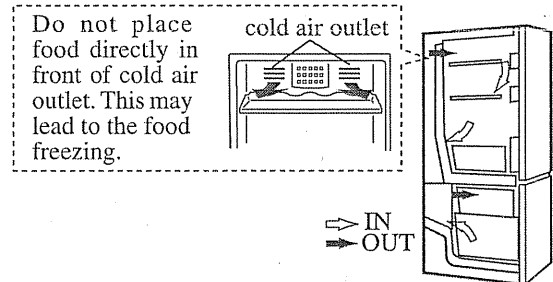

FOR BEST FREEZING

- Quality of foods should be fresh.
- Freeze small quantities of food at a time to freeze them quickly.
- Food should be properly stored or covered and the air should be removed to seal tightly.
- Evenly place the food in the freezer.
- Label bags or containers to keep an inventory of freezing food.

CARE AND MAINTENANCE

Some household cleaning chemicals may affect the inside surfaces and plastic shelves resulting in splitting or cracks occurring.

When cleaning all plastic parts inside this refrigerator, only use diluted dishwashing liquid (soapy water). Make sure that all plastic parts are thoroughly rinsed with water after cleaning.

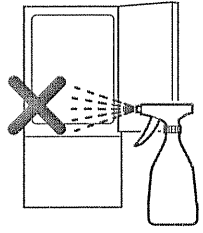

1. Remove the shelves and pockets from the cabinet and door. Wash them in warm soapy dishwashing water; rinse in clean water and dry.
2. Clean the inside with a cloth soaked in warm soapy dishwashing water. Then, use cold water to wipe off soapy water.
3. Wipe the exterior with a soft cloth each time when it is soiled.
4. Clean magnetic door seal with a toothbrush and warm soapy dishwashing water.
5. Whenever the refrigerator is moved to clean or repositioned, the evaporating pan should be removed and cleaned.

NOTE:

- Do not use polishing powder, benzine, hot water etc.
- If undiluted detergent is used or soapy water is not wiped off thoroughly, cracking of plastic parts can result.
- Wipe any food oils adhered to plastic components as they can cause cracking of the plastic surface.

Evaporating pan

How to remove:

Pull the evaporating pan toward yourself.

Evaporating pan

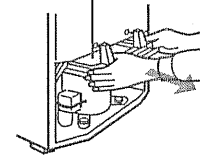

How to set:

1. Make sure the back end of the evaporating pan rests securely on the claw. Otherwise water will leak.

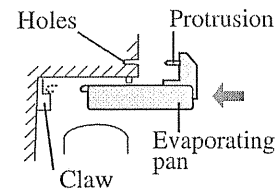

2. Set the evaporating pan so that the two protrusions come through its corresponding holes.

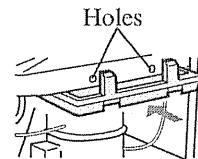

Replacing lamp bulb by service personnel

Lamp and lamp holder are integrated and they cannot be disassembled. So, customer please do not replace lamp and lamp holder by yourself and please ask service personnel authorized by Sharp for replacement, if necessary.

Switching off your refrigerator

If you switch your refrigerator off when you are going away for an extended period, remove all food, clean the interior thoroughly. Remove the power plug from the power socket and leave all doors open.

BEFORE CALLING FOR SERVICE

Before calling for service, check the following points.

IT IS NORMAL for the refrigerator to produce the following sounds.

- Loud noise produced by the compressor when operation starts --- Sound becomes quieter after a while.
- Loud noise produced once a day by the compressor --- Operating sound produced immediately after automatic defrost operation.
- Sound of flowing fluid (gurgling sound, fizzing sound) --- Sound of refrigerant flowing in pipes (sound may become louder from time to time).

- Cracking or crunching sound --- Sound produced by expansion and contraction of inner walls and internal parts during cooling.
- Squeaking sound --- Sound produced by expansion and contraction of internal parts.

IT IS NORMAL that the outside of a cabinet may be hot when touched. The hot pipe is in the cabinet in order to prevent dew generation.

IF YOU STILL REQUIRE SERVICE

Refer to your nearest service agent approved by SHARP.

警告

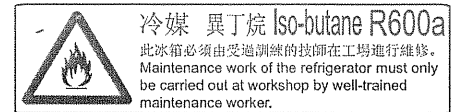

1. 本雪櫃含有易燃的製冷劑 (R600a: 異丁烷) 和易燃的絕緣發泡材料 (環戊烷)。
請遵循以下警告事項以防止著火和爆炸:
 - ① 雪櫃內部及背後的製冷系統含有製冷劑, 嚴禁以任何尖銳物體接觸製冷系統。
 - ② 嚴禁在雪櫃內部使用其他電器。
 - ③ 請看管好小孩, 以免損壞液化石油氣家用雪櫃。
 - ④ 切勿使用任何機械工具或其他方法來加速除霜過程 (本雪櫃已經採用自動除霜系統)。
 - ⑤ 不要堵塞雪櫃周圍的空間。
 - ⑥ 如果雪櫃製冷系統遭到破壞並有氣體洩漏, 請不要操作任何電源插座和使用明火。應打開窗戶讓空氣流通, 然後聯絡SHARP認可的售後服務中心進行修理。
 - ⑦ 警告標籤和銘牌必須一直牢固張貼於壓縮機上和雪櫃上。使用說明書應該妥善存放。如果雪櫃要搬運到另一地方或交給回收商, 使用說明書亦應該與雪櫃一併交給予處理和運送的人士。
 - ⑧ 雪櫃只能使用指定規格的照明燈。
 - ⑨ 雪櫃廢棄時應進行適當處理, 將雪櫃送到再循環工廠對易燃的製冷劑和易燃的絕緣發泡材料進行處置。
2. 本雪櫃為密封式結構。為防止發生兒童窒息意外, 請在扔棄雪櫃之前, 將所有雪櫃門完全拆下。
3. 乙醚、汽油、丙烷氣、粘合劑、純乙醇等高揮發性物質和易燃性物質有爆炸之危險。請勿將這類物質保存在雪櫃內。
4. 為防止雪櫃的表面受到損壞, 請勿使噴漆及塗料等接觸雪櫃。
5. 清潔雪櫃時, 請勿直接將水灑在雪櫃的內部和外部。這樣會導致生鏽及絕緣性能下降。
6. 在清潔電器部件周圍時, 請先拔出電源插頭以防止觸電。
7. 不慎將水灑在電路上的部件時, 請先拔掉雪櫃的插頭, 使該部件乾透, 然後與就近的SHARP認可售後服務中心聯繫。
8. 拔出電源插頭時, 請不要接觸插頭的金屬端子, 因為這樣會造成觸電。
9. 本雪櫃是按照說明書所示的方法使用, 為儲存家庭的食物而設計的。若將其使用於其他目的上, 會對人或財產造成損害。
10. 本雪櫃不宜用來儲藏需要準確儲存溫度的物件。這類物件一旦變質, 將是很危險的。
11. 電源插頭上積滿灰塵可以引起火災。因此, 請時常將其擦淨。
12. 請勿嘗試改裝雪櫃。這會導致火災、觸電和其他傷害。

安全注意事項

1. 請勿觸摸壓縮機及其周邊部件。因為這些部件的溫度在雪櫃運行過程中會變得非常高, 而且這些部件的邊角會對人造成傷害。
2. 電源因某些原因中斷時, 請等至少6分鐘之後才再接上電源。因為壓縮機所承受的冷媒壓力會使過負荷繼電器跳開。
3. 請避免光著手從冷凍室中取出食物。直接觸摸被保存在0°C以下的食物, 有時會引起凍傷。
4. 為防止電源突然中斷或不穩定, 請為雪櫃的插頭準確一個專用插座。由於電源不穩定會導致在雪櫃內的食物腐爛變質。
5. 因為瓶子凍結後會碎裂, 因此, 請勿將瓶子放進冷凍室內。
6. 請妥善關好雪櫃門。雪櫃門即使是稍微開放, 所調節的內部溫度將會升高, 因而導致食物腐爛和電費增加。
7. 請勿將雪櫃放置在潮濕的環境中, 因為這會對絕緣層造成傷害而導致觸電以及雪櫃外殼結露而導致生鏽。
8. 在安裝和搬移雪櫃時, 請勿挾住或扭曲電源線。由於電源線的損壞有時會導致觸電和火災。
9. 當電源線和電源插頭受到損壞、或是插頭沒有被插緊時, 請勿使用雪櫃。這樣可能會導致觸電和著火。
10. 切斷電源插頭時, 請不要只拉扯電源線, 應該拿住插頭端拔出。拉扯電源線會導致觸電和著火。
11. 為防止壓縮機過熱和停止運轉, 雪櫃的周圍要留有足夠的通風空間。請參照安裝程序進行。
12. 電源線損壞時, 請聯絡SHARP的維修服務中心作更換。因為需要特定的電源線。
13. 一旦發生氣體洩漏事故, 請勿用手去觸摸雪櫃和插頭, 要打開窗戶通風。
14. 請勿將重物 and 易碎物品放在雪櫃頂部。這類物品會因開關雪櫃門而掉落下來, 從而導致身體受傷。
15. 請勿將裝有液體的容器放在雪櫃頂部。液體潑翻時會導致觸電或火災。
16. 在雪櫃內部要防止物體掉落並砸向內膽, 否則可能會造成內膽爆裂。
17. 除非得到監護人或負責其安全人士的適當監督或指導, 否則, 此雪櫃不適合身體官能或心智能力退化者, 或缺乏操作經驗和知識的人士 (包括兒童) 使用。
18. 兒童應受到適當監管, 以確保不會以此雪櫃作玩具。

各部分名稱

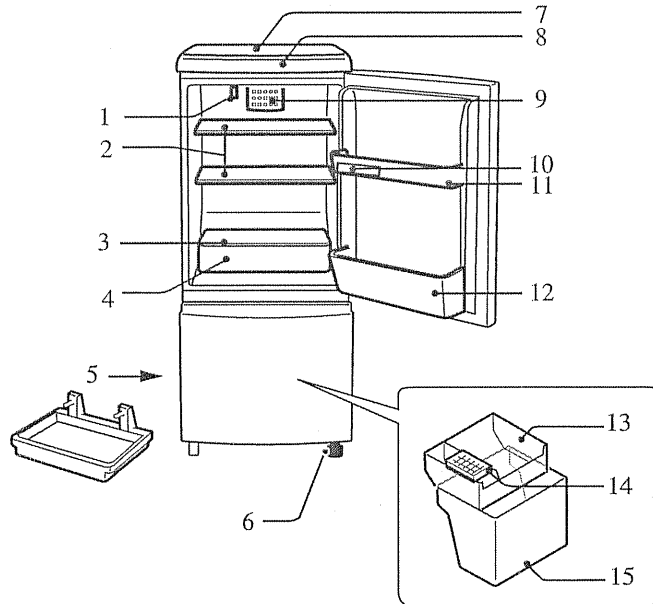

1. 冷凍室溫度調節掣
2. 強化玻璃層架
3. 保鮮室頂層架
4. 保鮮室
5. 蒸發盤
6. 可調校櫃腳
7. 茶几式機頂

請勿將熱的東西放在雪櫃機頂上，
茶几式機頂會溶化而變形。
其耐熱溫度為100℃。

8. 蓋板
9. 照明燈（更換照明燈請看15頁）
10. 蛋架
11. 門架
12. 瓶架
13. 滑動室
14. 製冰盒
15. 冷凍室

安裝

1. 為確保雪櫃有足夠的通風環境，建議在雪櫃的左右兩側和背面要預留6厘米的空間，雪櫃頂部要預留30厘米的空間。若空間不夠會降低製冷效率並導致不必要的耗電。
2. 請利用前面的可調校櫃腳，將雪櫃穩妥地安裝在地板的水平位置上。

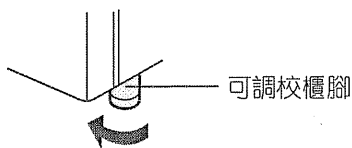

3. 為防止觸電，請將接地線連接至雪櫃背面的地線並用螺絲鎖緊。
4. 將蒸發盤（放置在雪櫃內部）安裝在雪櫃後面。（參照15頁）

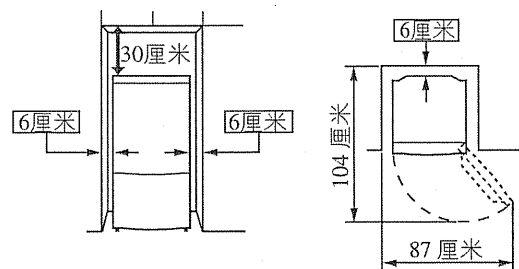

請注意：

- 將雪櫃放置在便於拔插電源插頭的適當地方。
- 請勿將雪櫃放在陽光直接照射到的地方。
- 請勿將雪櫃放在發熱機器的旁邊。
- 請勿將雪櫃直接放在地面上。請準備適當的台座。

在使用您的雪櫃之前：

請用布及溫水清潔雪櫃內部。如果使用了肥皂水，請徹底抹淨。

如何改變雪櫃門的開啟方向

雪櫃門的開啟方向可以改變至左邊。
請準備一字型螺絲刀。

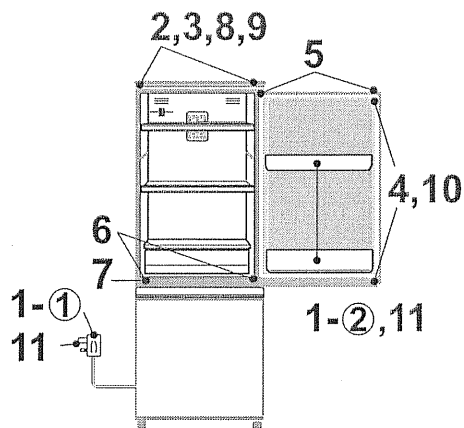

請注意：

- 改變雪櫃門的開啟方向，請遵循右側的指導進行並確保準確地變更了每個部位，否則冷藏室門可能會在使用中掉落。
- 在安裝過程中當心冷藏室門會掉落，造成傷害。
- 不要讓嬰兒接觸移除出來的部件。
- 不要清除門軸和門上的潤滑油。

1 準備

- (1) 拔下電源插座。
- (2) 拆除所有門架。

2 在冷藏室門處於關閉狀態下，取下蓋板。

- (1) 用手按壓標記處（共2個），使鉤卡鬆開並將蓋板向前拉。

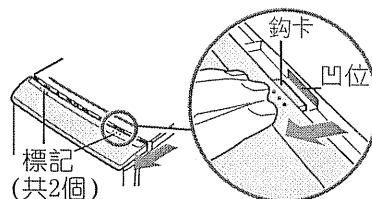

- (2) 壓按蓋板內部的同時，用手托住其蓋板。

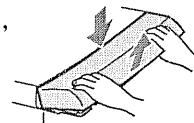

3 關閉冷藏室門並以螺絲刀

- 拔出右上側的上軸承
(在打開門狀態執行時，冷藏室門有可能會脫落)

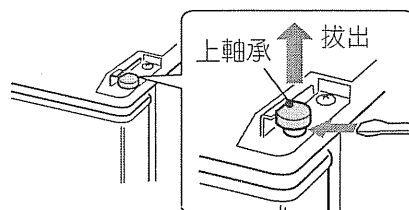

4 用雙手取下冷藏室門並放在地面。

- 托住門的上部，將其移向自己並向上托起。
- 放在地面時請注意不要讓其倒下造成損壞及刮花地板表面。

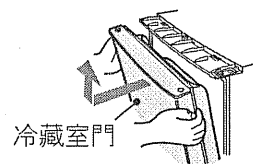

5 將取下的門的上軸承和孔罩調換至另一邊。

- 用螺絲刀如圖所示壓住孔罩凹陷位將其取出

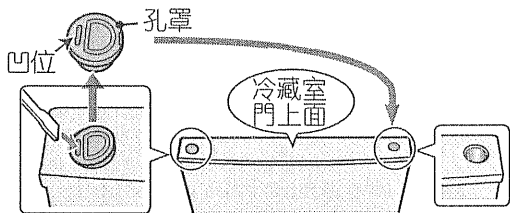

- 如果不能穩固地安裝上孔罩，將會有可能脫落及掉失

6 從右軸固定銷上取出下軸承，將該下軸承放到左側的軸固定銷上。

下軸承有可能黏附在拆下的門的下側

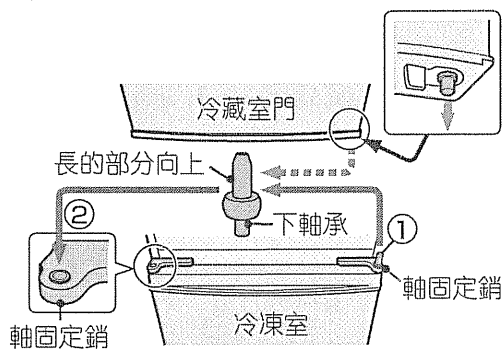

7 將冷藏室門左下側的孔插進下軸承

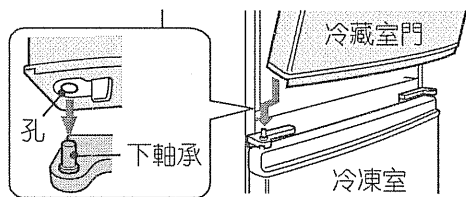

- 請務必托住冷藏室門，避免其掉落。
- 請注意不要將手指放在冷藏室門和下軸承之間，有被夾的可能。

8 關閉冷藏室門，對準孔，插入上軸承。

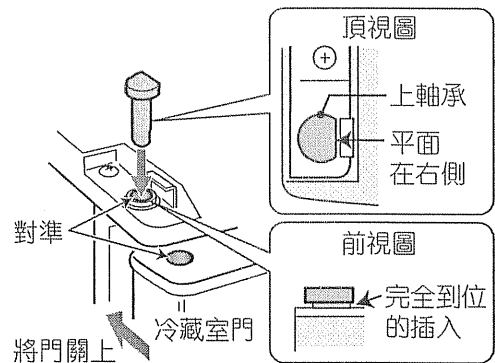

9 安裝蓋板

(1) 向上傾斜蓋板，將內部卡子對準機頂的孔。

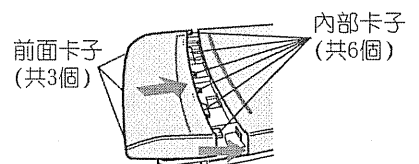

(2) 將卡子插入孔內。

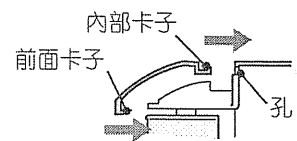

(3) 從上面按壓蓋板，並將前面的卡子插入到位。

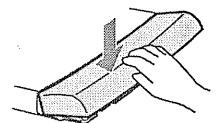

- 請確定蓋板穩固裝妥。
- 上軸承如不完全插入的話，蓋板會有翹起的可能。

10 請確認冷藏室的門是否能順暢開關。

11 安裝門架，插上電源插座。

左開門轉換到右開門時，請按照同樣操作順序進行。

使用方法

溫度調節

冷藏室無溫度調節鈕，冷藏室可自動調節溫度。
如有需要，請按如下方法調節溫度。

冷凍室

一般設定在[通常]位置，溫度穩定時，冷凍室中間偏下處的溫度約在-18℃左右。

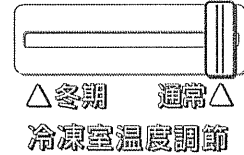

冬季時當周圍溫度較低（約10℃以下），請將溫度調節鈕設在[冬期]位置使用。

注意：

- 夏天若將冷凍室溫度調節鈕設置於[冬期]位置，會導致冷藏室冷凍不足。 ▶ 請將冷凍室溫度調節鈕設置於[通常]位置，讓冷藏室製冷。
- 冬天若將冷凍室溫度調節鈕設置於[通常]位置，會導致冷凍室冷凍不足。 ▶ 請將冷凍室溫度調節鈕設置於[冬期]位置，讓冷凍室製冷。
- 如果用戶希望把食品盡快冷凍，請將冷凍室溫度調節鈕設置於[冬期]位置。

■ 附屬品的使用

強化玻璃層架

請按圖示方向插入
若將印刷面向上則
有可能刮花印刷面

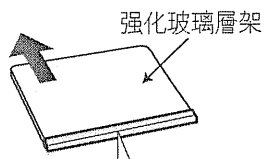

請將裝飾條面向自己。
否則會碰壞冰箱內壁。

層架

- 食物要放入層架內側。
(若不放好，則門關閉時可能會掉落。)
- 請勿將食物疊高。
(否則開門時可能會掉落。)

保鮮室、保鮮室頂層架

保鮮室

溫度比冷藏室低1-2℃，適合
保存鮮魚及肉類。

請勿放入蔬菜等含水的食物
因為有可能會使蔬菜凍結。

保鮮室頂層架

“前”表示
面向自己安裝

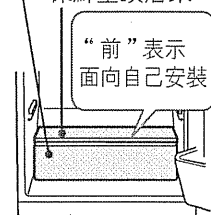

整個冷凍室的拆卸方法

- (1)將門完全拉出，
放在地上。
- (2)取出整個冷凍室。

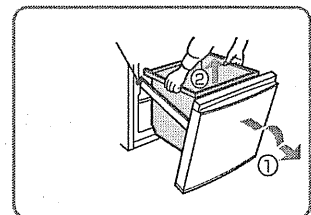

製冰方法

1. 請勿將過量的水放入製冰盒內。否則，製成的冰會連結在一起。
2. 冰塊製成以後，握住製冰盒並將之倒置，朝相反方向扭轉任何一端，使冰塊倒出來。

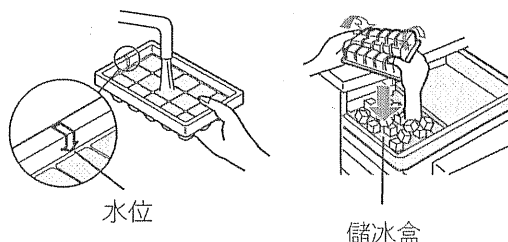

請注意：為了不損壞滑動室，請勿在滑動室的冰盒內直接製冰或將油倒在滑動室內。

除霜

本雪櫃通過獨特的節約能源系統，完全實現自動除霜。除霜周期與雪櫃的壓縮機運轉時間成反比。也就是說，雪櫃壓縮機運轉時間越短（冬天及因休假而外出時），除霜的周期也就越長。

除臭裝置

此裝置不需人工操作。只要插上雪櫃的電源，就會自動進入操作狀態。

食物的儲存

將食物冷藏起來時，食物腐爛的速度就會減緩。要延長易於腐爛食物的品嘗期限，就應當盡可能選擇較新鮮的食物。下面為延長食物保鮮期限的簡要介紹，可供參考。

水果 / 蔬菜

為盡量減少水分流失，水果和蔬菜要用保鮮紙及袋子（不封口）之類的塑料袋輕輕包上，並將其放入保鮮室內。鮮橙等表皮較厚的水果或蔬菜則不用保鮮紙包上即可放入。

乳製品

- 幾乎所有乳製品的包裝外面都標有適當的保存溫度和品嘗期限。

肉類 / 魚 / 家禽

- 將其放在容器上，並包上保鮮紙。
- 若是大塊的肉、魚和家禽，請將其放在層架的內側。
- 已經煮熟的食物必須用保鮮紙包好，或將其放在密封容器內。

請注意：

- 為使冷氣充分循環，請將食物均勻地放在層架上。
- 請將較熱的食物涼下來以後再保存起來。如果將較熱的食物放進雪櫃，雪櫃內的溫度會升高，這樣往往很容易導致食物腐爛變質。
- 請勿讓食物和容器擋住冷氣循環的出風口和吸入口。否則，食物就不能均勻地冷卻。

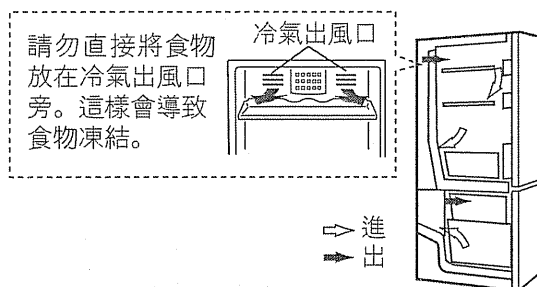

為達到最佳冷凍效果

- 食物應當新鮮。
- 若要快速冷凍食物，每次都必須少量放入。
- 食物應適當地放入容器或用保鮮紙包好，若要將食物密封起來，最好將空氣抽出。
- 將食物均勻地放入冷凍室。
- 袋子和容器上要貼上標示，並寫清楚冷凍食物內容。

保養和清潔

一些家用化學清潔劑可能會腐蝕雪櫃內膽和塑膠部件並導致裂縫的產生。

當清洗雪櫃內所有的塑膠部件時，只能使用稀釋過的廚房用清潔劑（肥皂水）。清潔完畢後務必用水徹底洗淨。

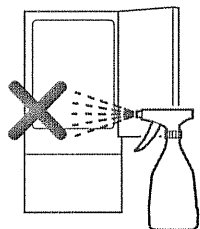

1. 拆下雪櫃內的層架、門架和瓶架。

用溫水和廚房用清潔劑清洗。用水洗清並使之乾透。

2. 雪櫃內部要用浸泡在廚房用清潔劑的溫水裡的布塊擦洗。然後，用冷水將肥皂水擦乾淨。
3. 雪櫃的外殼沾上污漬時，請用柔軟的布塊擦洗。
4. 雪櫃門的膠邊要用已稀釋的廚房用清潔劑和牙刷洗淨。
5. 在移動雪櫃進行掃除或重新設置雪櫃時，請將蒸發盤拆下並清洗乾淨。

請注意：

- 請勿使用研磨粉、輕質汽油和熱水等作清潔之用。
- 如果使用未稀釋的清潔劑或者未徹底擦乾淨肥皂水，則有可能損壞雪櫃的塑膠部件。
- 食用油沾上塑膠部件時，請將之擦掉。因為這類油會導致塑膠表面產生裂縫。

送修之前的初步檢查

送修之前，請對以下幾點進行確認：

雪櫃若發出下列聲音，是正常的：

- 運轉開始時，壓縮機發出較大的噪音---不久聲音會變小。
- 壓縮機每日一次發出較大噪音---緊隨自動除霜操作之後發出的運轉聲。
- 液體流動的聲音（咕嚕聲、嘶嘶聲）--- 製冷劑在管道內流動的聲音（聲音有時會變得較大）。

蒸發盤

取出的方法：
將蒸發盤往前拉出

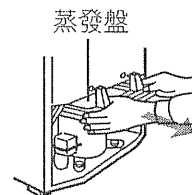

裝上的方法：

1. 務必將蒸發盤的後端牢固地安裝在卡爪上。以免滲漏。

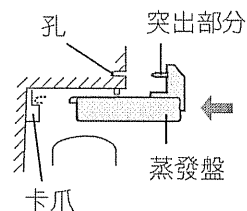

2. 將蒸發盤的突出部分套在雪櫃背面的孔中。

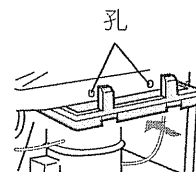

燈泡更換方法：

雪櫃內的照明燈與燈座為一體化連接，用戶不可自行更換，請與就近的SHARP售後服務中心聯繫更換。

切斷雪櫃電源時：

長期出門的時候，如果要切斷雪櫃的電源，請取出雪櫃內的全部食物，並將內部徹底擦洗乾淨。請從插座上拔出電源插頭，並打開雪櫃門。

- 劈啪聲或吱嘎聲 --- 製冷時內壁和內部零件膨脹和收縮的聲音。
- 吱吱聲 --- 內部零件膨脹和收縮的聲音。

雪櫃外箱有時會變熱，這是正常的。
因為防止結露的熱導管裝在機身的內部。

若經檢查後仍需要送修時
請與就近的SHARP售後服務中心查詢。

SHARP
SHARP CORPORATION

TINS-A076RDR0 14A ①